

VEGA

Hotel
Restaurant
Catering



10099883 EN0319VEGA

Annual Catalog 2019

www.em-group.com

DUNEO

With clean lines and filigree design DUNEO brings Nordic flair in your rooms. Thus, the tables and chairs with the exposed legs are absolutely trendy. They are made of solid beech and oak wood and fit beautiful in your ambience. Your benefit: You can assemble the individual parts of the series according to your taste - depending on which table shape, size or color you want to have. The high-quality HPL coating makes the table tops robust, scratch-resistant and easy care. The edge made of solid wood also speak for the quality of the furniture. Underline your individual style.



Table top
3 shapes - 2 colors



Table legs
2 colors - 2 heights



Seat shell
2 colors



Chair legs
2 colors

Chair
DUNEO, from

109⁹⁸

- High quality
- Nordic design
- Combinable

> All items of the furniture series DUNEO
see p. 320

DUNEO

*A furniture series
with many possible
combinations*

✦ Made of solid
wood: Stable

✦ Attractive design thanks to
table edge made of solid wood

Chair
DUNEO, from
109⁹⁸

Table top
DUNEO, from
89⁹⁹

✦ HPL coating: Robust
and scratch-resistant



Chair
DUNEO, from
109,98

- Solid wood
- Modular

2

6

12

4

Furniture series DUNEO

This furniture series made of solid beech and oak wood sets your individuality no limits, because it offers almost unlimited combination possibilities! With their Nordic charm, the tables and chairs are very trendy. Thanks to the high-quality HPL coating, the table tops and seat shells are robust, scratch-resistant and easy to clean. The solid wood edge made of oiled beech wood of the table also speaks for the quality of the tables. The table legs are available in solid wood oak or beech, at the chair frames you can choose between two different variants made of solid oak. Including floor-protecting plastic gliders.

Combine your chair



1

2

3

4

Examples of possible combinations:



3

11

20

Chair
109,98 €

Table
258,00 €

Lounge table
188,99 €

	WxDxH cm	Weight kg	Color	Ref.	Pcs./pack	Pack €	Piece €
1	41x46x40	2.8	sand	30002837	2	79,98	39,99
2			anthracite	30002836	2	79,98	39,99
3	38x46x44	2.7	oak natural	30002838	2	139,98	69,99
4			oak tobacco	30002839	2	149,98	74,99

Combine your table

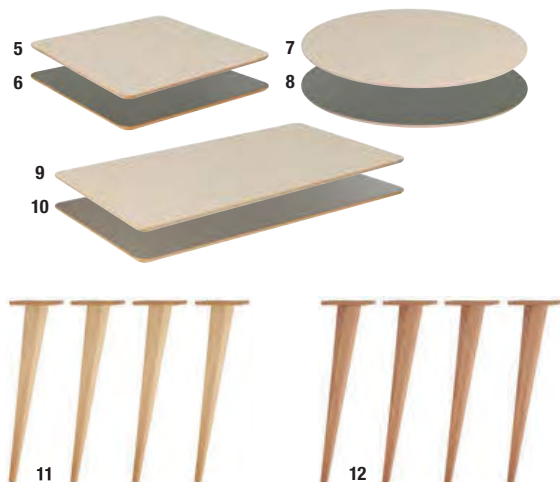

5

7

6

8

9

10

11

12

Combine your lounge table

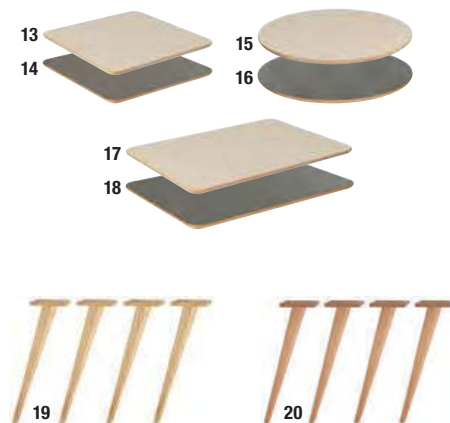

13

15

14

16

17

18

19

20

	Dimension cm	Weight kg	Color	Ref.	Piece €
5	LxWxH	10.7	sand	30002831	129,00
6	square		75.0x75.0x2.5	anthracite	30002830
7	Table top round	14.9	sand	30002824	199,00
8			100.0x2.5	anthracite	30002825
9	Table top rectangular	19.9	sand	30002835	179,00
10			140.0x75.0x2.5	anthracite	30002834
11	Table legs high (4-piece set)	4.5	oak natural	30002842	129,00
12			73.4	beech tobacco	30002841

	Dimension cm	Weight kg	Color	Ref.	Piece €
13	Table top square	5.8	sand	30002829	89,99
14			55.0x55.0x2.5	anthracite	30002828
15	Table top round	5.4	sand	30002827	119,00
16			60.0x2.5	anthracite	30002826
17	Table top rectangular	8.4	sand	30002833	109,00
18			80.0x55.0x2.5	anthracite	30002832
19	Table legs low (4-piece set)	1.4	oak natural	30002844	79,99
20			42.9	beech tobacco	30002843

i

Extend your tables

1. Screw the connector set to both tables (see picture)
2. Position your tables
3. Insert the additional table top and screw it down



Connector set
CAMPANO
34,99



	WxDxH cm	Weight kg	Ref.	Piece €
21	30x4x2	1.1	10008457	34,99



Chair
CAMPANO, from
99⁰⁰

Furniture indoor

Additional table top
CAMPANO, from
125⁰⁰



22



24



30



26



32



28

Table
CAMPANO, from
279⁰⁰

- Solid wood
- Easy to clean
- Extendable by additional table top



23



25



31



27



33



29

Furniture series CAMPANO

The furniture series CAMPANO convinces with best quality and classic simplicity. The material is high-quality, solid oak wood in the colors natural and tobacco stained. The handcrafted surface of the comfortable chairs with their ergonomic seat recesses and the tables in different sizes is lightly brushed and easy to clean. The tables can be extended with additional table tops in two sizes. The connector rails simply disappear under the table top when not in use. Stable struts made of lacquered steel prevent distortion of the table top.

Material: Oak solid, stained.
Easy to clean! Functional!



	LxWxH cm	Weight kg	Color	Ref.	Pcs./pack	Pack €	Piece €
22 Chair	WxDxH	7.0	tobacco stained	10008445	2	218,00	109,00
23 (seat height 47 cm)	42.0x46.0x84.0		oak natural	10008446	2	198,00	99,00
Table	80.0x80.0x77.0	29.8	tobacco stained	10008451	1	-	299,00
			oak natural	10008452	1	-	279,00
	140.0x80.0x77.0	45.5	tobacco stained	10008453	1	-	399,00
			oak natural	10008454	1	-	379,00
	180.0x80.0x77.0	51.5	tobacco stained	10008455	1	-	499,00
			oak natural	10008456	1	-	479,00
30 Additional table top square	80.0x80.0x2.8	15.5	tobacco stained	10008447	1	-	129,00
31	oak natural		10008448	1	-	125,00	
32 Additional table top rectangular	120.0x80.0x2.8	22.8	tobacco stained	10008449	1	-	179,00
33	oak natural		10008450	1	-	175,00	



+49 8272 807 447



service@em-group.com



www.em-group.com

321



■ Easy to clean



■ Aluminum profiles on the foot rests
■ 2 sizes



Stool
DONATO, from
89,99



Another
color of
DONATO can be found at

www.em-group.com



Solid wood series DONATO

Sturdy robustness combined with a straightforward design. The solid legs of table and bench measure 10x10 cm (stool: 8x8 cm). The table top has a thickness of 1.8 cm and is doubled at the edge to 3.6 cm. The foot rests of the bar tables are protected with aluminum profiles. For daily care, wet wiping of the lacquered surface is sufficient. Delivered disassembled, incl. mounting material and instructions. Stool delivered assembled.

Easy to clean!

	WxDxH cm	Weight kg	Ref.	Pcs./pack	Pack €	Piece €
1 Stool	38x38x45	12.1	10093413	2	179,98	89,99
2 Bench	160x38x45	26.1	10093410	1	-	229,00
3 Table	160x80x77	45.9	10093407	1	-	519,00
4 Bar table	70x70x110	45.2	10093943	1	-	459,00
	70x120x110	49.8	10093945	1	-	539,00

Furniture series TORONTO

Elegant, durable and comfortable: The furniture series TORONTO impresses with its design and quality. With slanted legs and the slanted table top, it inspires your guests. All parts are made of high-quality oak wood and available in natural or tobacco. The foot rest of the barstool is made of brushed stainless steel. At the tables steel bars prevent the table top from warping. Another special feature: Bar tables and barstools are a little bit lower than conventional bar furniture. So they do not seem so bulky in your ambience and make sitting down and getting up easier and more comfortable. The seat recess at the barstools and the bench ensures that your guests sit ergonomic and comfortable - so they will be happy to spend more time at your bar.

Material: High-quality oak wood.

NEW



Table
TORONTO, from
279⁰⁰

Furniture indoor

- Ergonomically shaped seat
- Foot rest made of stainless steel

- Solid wood
- Easy to clean
- Stable and robust

- Intermediate height



	WxDxH cm	Weight kg	Color	Ref.	Pcs./ pack	Pack €	Piece €
5	46x46x65	4.6	oak natural	30003548	2	159,98	79,99
6			tobacco stained	30003549	2	179,98	89,99
7	140x38x45	23.0	oak natural	30003536	1	-	189,00
8			tobacco stained	30003537	1	-	199,00
9	180x38x45	27.0	oak natural	30003534	1	-	229,00
10			tobacco stained	30003535	1	-	239,00
11	70x70x96	40.0	oak natural	30003540	1	-	279,00
12			tobacco stained	30003541	1	-	299,00
13	120x70x96	43.5	oak natural	30003538	1	-	379,00
14			tobacco stained	30003539	1	-	399,00

	WxDxH cm	Weight kg	Color	Ref.	Pcs./ pack	Pack €	Piece €
15	80x80x75	35.0	oak natural	30003546	1	-	279,00
16			tobacco stained	30003547	1	-	299,00
17	140x80x75	48.0	oak natural	30003544	1	-	379,00
18			tobacco stained	30003545	1	-	399,00
19	180x80x75	57.0	oak natural	30003542	1	-	479,00
20			tobacco stained	30003543	1	-	499,00

*Delivered disassembled, incl. mounting material.



Bar table 70x70x110 cm
CARELL, from
229⁰⁰

> Bar chair HAVANNA see p. 300

- 3 colors
- For 2 or 4 persons



Bar table CARELL

The table top is made of real wood veneered and the table legs are made of solid veneered beech wood. Table top thickness: 3.5 cm. Dimension of the legs: 10x10 cm. Delivery in kit - easy assembly, delivered disassembled.

Easy to clean! For indoors only! 3-year availability guarantee!

	LxWxH cm	Weight kg	Color	Ref.	Piece €
1	70x70x110	30.2	ash walnut stained	10089475	229,00
2			ash black stained	10089605	229,00
3			oak natural	10089890	259,00
4	120x70x110	41.1	ash walnut stained	10089476	299,00
5			ash black stained	10089606	299,00
6			oak natural	10089891	329,00
			LxW cm	Ref.	Set €
Foot rest made of stainless steel			55.0x2.6	10094573	10,99
7 (4-piece)			55.0x2.6/105.0x2.6	10094574	16,99

Lounge table LUCA, from

81⁹⁹

- 2 colors
- Square or rectangular



Lounge table LUCA

The table top is made of real wood veneered and the table legs are made of solid veneered beech wood. Table top thickness: 3.5 cm. Dimension of the legs: 5x5 cm. Delivery in kit - easy assembly, delivered disassembled.

Easy to clean! For indoors only!

	LxWxH cm	Weight kg	Color	Ref.	Piece €
8	55x55x45	8.5	oak natural	10089795	105,00
9			ash walnut stained	10089470	81,99
10	90x55x45	11.5	oak natural	10089794	145,00
11			ash walnut stained	10089530	125,00



> Sofa TEATRO see p. 278, 279



Table 70.0x70.0x75.5 cm
KARL, from

169⁰⁰

>2-seater sofa WINSTON see p. 285

Furniture indoor

Fits perfectly into any ambience



- 4 colors
- For 2 or 4 persons

Table 120.0x70.0x75.5 cm
KARL, from

199⁰⁰

Table KARL

This series is made of solid, veneered beech wood table legs and a veneered table top! Table top thickness: 3.5 cm. Dimension of the legs: 5x5 cm. Delivery in kit - easy assembly, delivered disassembled.

Easy to clean! For indoors only! 3-year availability guarantee!

	LxWxH cm	Weight kg	Color	Ref.	Piece €		LxWxH cm	Weight kg	Color	Ref.	Piece €
12	70.0x70.0x75.5	18.3	oak natural	10089867	179,00	16	120.0x70.0x75.5	25.7	oak natural	10089869	219,00
13			ash black stained	10089608	169,00	17			ash black stained	10089610	199,00
14			ash walnut stained	10089472	169,00	18			ash walnut stained	10089474	199,00
15			beech natural	10089871	169,00	19			beech natural	10089873	199,00
	80.0x80.0x75.5	22.2	oak natural	10089866	195,00				oak natural	10089868	229,00
			ash black stained	10089607	185,00		ash black stained	10089609	219,00		
			ash walnut stained	10089471	185,00		ash walnut stained	10089473	219,00		
			beech natural	10089870	185,00		beech natural	10089872	219,00		



Table
MURPHY, from
199⁰⁰

> Chair CHARMANT see p. 297

Straight, noble & high quality



1



4

■ Easy to clean



2



5



3



6

Table MURPHY

Beautiful, robust and hard-wearing - these tables are perfectly suited of your needs: The table top is real wood veneered and passes over an attractive shadow gap into the 7x7 cm thick legs made of solid beech. The top of the table continues at the side, which supports the solid wood look. With these durable tables you make a good choice!

Beautiful look thanks to solid and veneered legs! High quality workmanship! Shadow gap! Easy assembly! 3-year availability guarantee!



	LxWxH cm*	Weight kg	Color	Ref.	Piece €
1			ash walnut stained	10089468	199,00
2	80.0x80.0x75.5	26.8	oak natural	10089804	219,00
3			oak tobacco stained	10089809	229,00
4			ash walnut stained	10089469	229,00
5	120.0x80.0x75.5	33.6	oak natural	10089805	249,00
6			oak tobacco stained	10089808	269,00

*Table delivered disassembled, incl. screws!



Cutlery cupboard, from ALDENO
309⁰⁰

9

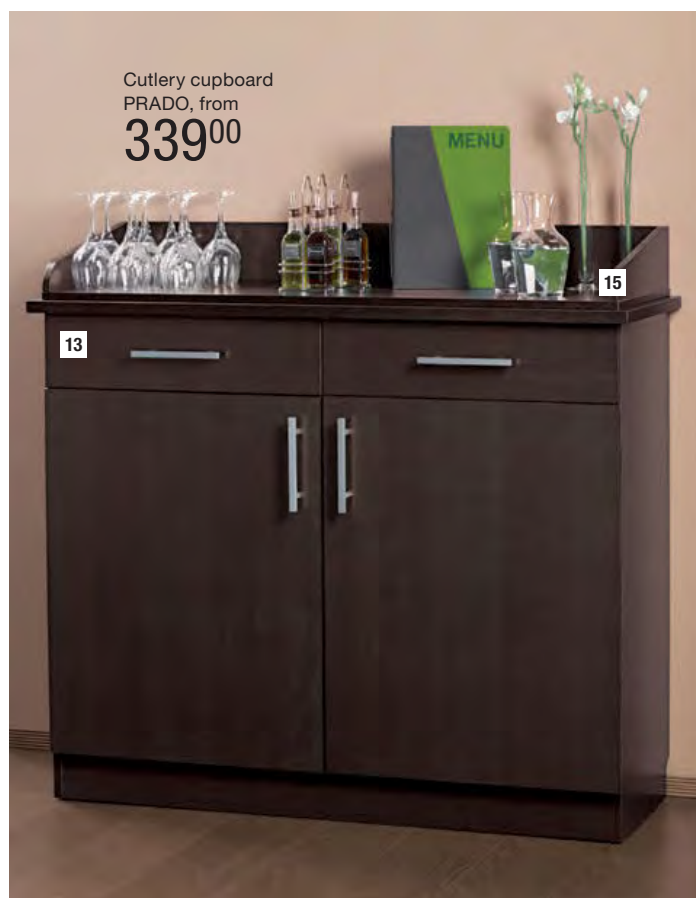

Cutlery cupboard PRADO, from
339⁰⁰

13

15

- Delivered assembled
- 3 or 6 compartments for cutlery

- Delivered assembled
- Drawers with soft closing



7



9



8



10



11



14



15



12



13

Cutlery cupboard ALDENO

Very handy helpers are our well-made cutlery cupboards, in which you always have cutlery, menus and cruet stands ready to hand. At the same time, the cupboard can also serve as a decorative room divider, because its rear panel is veneered and lacquered. Practical drawer with 6 compartments (LxW 13x32 cm) or 3 compartments (LxW 17x32 cm) for cutlery, napkins and much more. The cutlery cupboards are lined with felt. In the side compartment of the door is a height-adjustable shelf (fig. 9 - 11 LxW 36x38 cm, fig. 7, 8 LxW 58,5x33 cm). There are 2 or 3 possible shelf positions, the distance is 10 cm. In the open side compartment (only fig. 9 - 11) there are two shelves (LxW 58x38 cm).

Material: Real wood veneered! White color is lacquered!
Delivered assembled!

	LxWxH cm	Weight kg	Storage sur- face top WxD	Color	Ref.	Piece €
7	62x38x105	37.0	58.5x24.0	brown	10092917	309,00
8				black	10092919	309,00
9	100x38x105	52.9	96.0x24.0	brown	10091691	419,00
10				black	10091692	419,00
11				white	10091908	419,00

 Please contact our customer service for a sample set!
+49 8272 807 447

Cutlery cupboard PRADO

High-quality cutlery cupboards made of real wood veneered. Drawers suitable for VEGA cutlery boxes (Ref. 10040036, 10049439, www.em-group.com). High-quality drawers with soft closing. Hinges in professional quality, with 4 stable (fig. 12 with 2 stable), 12 mm thick, height-adjustable shelves. There are 17 possible shelf positions, the distance is 3 cm each. Rear wall in sight quality for an all-round perfect appearance. There are matching attachments available for the cutlery cupboards, see fig. 14, 15.

Material: Real wood veneered! Delivered assembled!

		Color	LxWxH cm	Weight kg	Ref.	Piece €
12	Cutlery cupboard	brown	66.0x47.0x105.0	51.3	10092924	339,00
			127.0x47.0x105.0	89.7	10091902	519,00
14	Attachment for	brown	61.0x44.7x14.5	5.7	10092932	49,99
15	cutlery cupboard		122.0x44.7x14.5	9.1	10091906	69,99



Furniture indoor

MODULATO – individually combinable



Service station MODULATO

This practical service station system can also be used as a counter or for storage with the front panel. For example, hide the coffee machine or your cash desk. The base module is delivered assembled, top panel, base and front panel can be easily attached. Drawers and doors can be opened by using the practical push-open-system and the high-quality drawers can be loaded up to 40 kg. The two height-adjustable, 16 mm thick shelves are also extremely stable and load-bearing. All service station elements are coated with a very high-quality, robust and easy care plastic decor, which is perfectly suited for gastronomy. Due to their structure and real color, the wood color tones can hardly be distinguished from real wood. Please order the matching base and top panel size according to the required number of base modules

Individually combinable! High-quality workmanship! Push-open-system!

1. Choose a base

Available in 4 lengths (for 1, 2, 3 or 4 modules) and in 2 colors

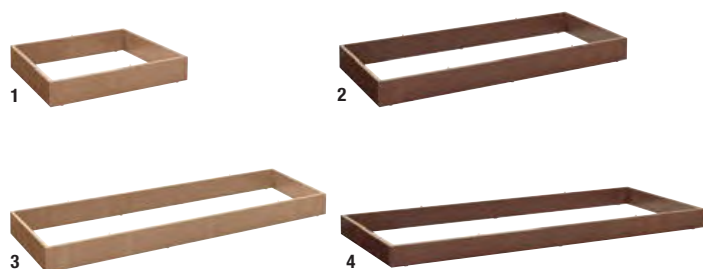

	LxWxH cm	Weight kg	Color	Ref.	Piece €
1 For 1 base module	60.0x50.0x11.0	2.6	oak	10089193	39,99
			tobacco	10089194	39,99
2 For 2 base modules	120.0x50.0x11.0	4.0	oak	10089195	49,99
			tobacco	10089196	49,99
3 For 3 base modules	180.0x50.0x11.0	5.5	oak	10089197	64,99
			tobacco	10089198	64,99
4 For 4 base modules	240.0x50.0x11.0	6.8	oak	10089199	79,99
			tobacco	10089200	79,99

3. Choose a matching top panel

Available in 4 lengths (for 1, 2, 3 or 4 modules) and in 2 colors

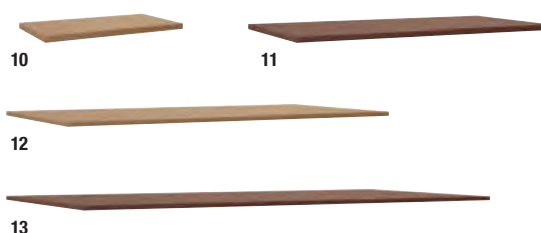

	LxWxH cm	Weight kg	Color	Ref.	Piece €
10 For 1 base module	60.0x60.0x2.5	6.1	oak	10089421	69,99
			tobacco	10089422	69,99
11 For 2 base modules	120.0x60.0x2.5	12.2	oak	10089330	99,99
			tobacco	10089424	99,99
12 For 3 base modules	180.0x60.0x2.5	18.3	oak	10089425	139,00
			tobacco	10089426	139,00
13 For 4 base modules	240.0x60.0x2.5	24.4	oak	10089427	169,00
			tobacco	10089428	169,00

2. Choose a base module

Various versions are available

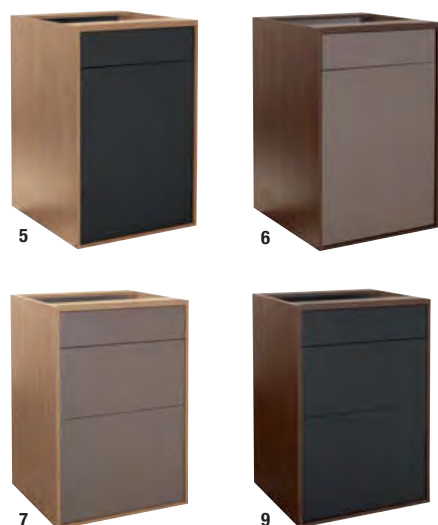

Base module with 1 drawer, 1 door and 2 adjustable shelves

Base module with 3 drawers in different heights

	LxWxH cm	Weight kg	Color	Ref.	Piece €
5 1 drawer, 6 1 door	60.0x60.0x86.2	37	oak/mocha	10089429	259,00
			oak/anthracite	10089430	259,00
			tobacco/mocha	10089431	259,00
			tobacco/anthracite	10089432	259,00
7 With 3 drawers 8 9	60.0x60.0x86.2	42	oak/mocha	10089433	329,00
			oak/anthracite	10089190	329,00
			tobacco/mocha	10089191	329,00
			tobacco/anthracite	10089192	329,00

4. Complete your service station with the matching front panel

With or without shelf, available in 2 lengths and 2 colors

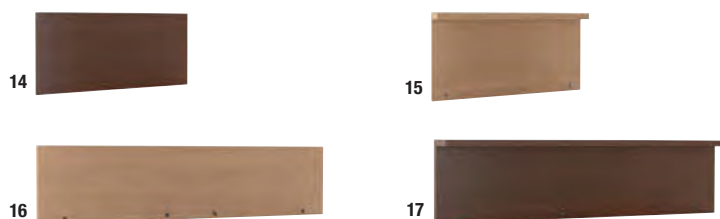

	LxWxH cm	Weight kg	Color	Ref.	Piece €
14 For 1 base module	60.0x28.0x2.5	2.9	oak	10089201	29,99
			tobacco	10089202	29,99
15 With shelf, for 1 base module	60.0x30.8x14.0	4.3	oak	10089205	49,99
			tobacco	10089206	49,99
16 For 2 base modules	120.0x28.0x2.5	5.8	oak	10089203	49,99
			tobacco	10089204	49,99
17 With shelf, for 2 base modules	120.0x30.8x14.0	8.6	oak	10089170	69,99
			tobacco	10089171	69,99

*Mounting material is included!

5. Cutlery holder



Cutlery holder MODULATO

649

	WxHxD cm	Ref.	Piece €
18 Cutlery holder for approx. 240 pieces	32.5x10.0x53.0	10089178	6,49



Base module
MODULATO, from
259⁰⁰

- Individually combinable
- Stable
- Versatile

Furniture indoor



Combination possibilities

Combine your service station as desired - several combinations possible.

- 1. Choose a base**
Available in 4 lengths (for 1, 2, 3 or 4 modules) and in 2 colors
- 2. Choose a base module**
Various versions are available
- 3. Choose a matching top panel**
Available in 4 lengths (for 1, 2, 3 or 4 modules) and in 2 colors
- 4. Complete your service station with the matching front panel**
With or without shelf, available in 2 lengths and 2 colors

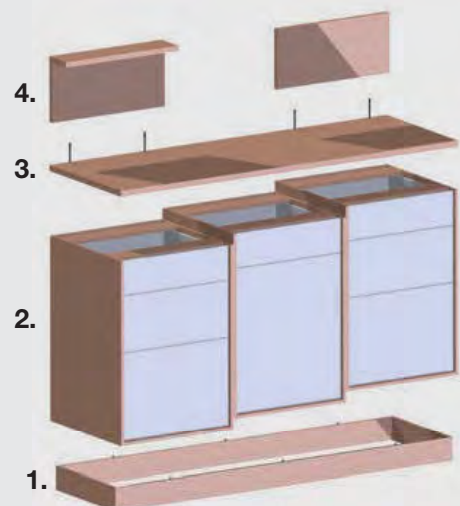

Versatile

Clearing trolley ODISSEO

Clearing trolley with two large (2/1 GN) and two small (1/1 GN) shelves. Wheels with soft and floor-friendly running surface (please order separately). In combination with the adapter frame, the clearing trolley can be equipped with wooden boards, carafe holders or bottle holders. This offers a lot of flexibility in your daily work!

Material: Solid oak wood. Material handle: Stainless steel.



Bottle holder



Adapter frame



Versatile thanks to removable shelves



1. Choose a clearing trolley

Available in 2 colors



- Combinable
- Easy to clean



2. Add the wheel set

4-piece wheel set

Wheel set 4-piece
ODISSEO

34⁹⁹



3

	Color	Ref.	Set €
3 Wheel set (4-piece)	black	30024595	34,99

	WxDxH cm	Weight kg	Color	Ref.	Piece €
1 Clearing trolley	114.0x35.5x92.5	24	oak natural	30024596	259,00
			tobacco stained	30024597	279,00



Your benefit

Can be combined with GN items, carafe holders, wooden boards and many other VEGA products.

Stay always flexible!

NEW



Clearing trolley
ODISSEO, from
293⁹⁹

Furniture indoor

3. Complete your clearing trolley with different inserts

Bottle holder, adapter frame or gastronorm container available

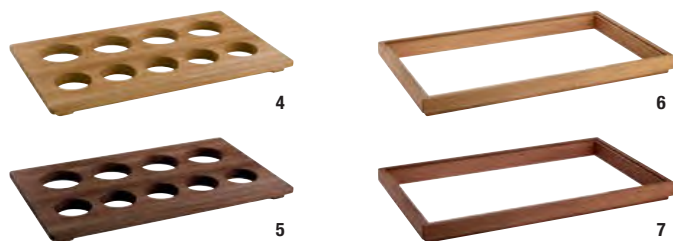

	WxDxH cm	Weight kg	Color	Ref.	Piece €
4	32.5x53.0x3.0	-	oak	30030766	34,99
5			walnut	30030767	49,99
6	34.0x54.5x4.0	-	oak	30024592	29,99
7			tobacco stained	30024593	29,99



■ 3 different materials

	LxWxD cm	Material	Color	Ref.	Piece €
8	53.0x32.5x6.5	Melamine	white	10006315	29,99
9			black	10006324	29,99
10		Polypropylene	-	10010359	9,59
11		Stainless steel 18/10	-	10081630	14,99

i

Combination possibilities

p. 224
fig. 14



Total price
505,94 €



Total price
433,55 €

Design your interiors DIVISO!



1. Choose a base element

Available in 4 colors



	LxWxH cm	Weight kg	Color	Ref.	Piece €
1	80.0x25.0x80.0	22	oak	10089411	129,00
2			tobacco	10089412	129,00
3			mocha	10070494	129,00
4			anthracite	10070498	129,00

Separation system DIVISO

If you are looking for a changeable separation system that can be used free-standing in the room or on the wall, this room divider is a very good choice! The basic element in natural wood look is available in the decor colors oak, tobacco, mocha or anthracite, which is an eye-catcher in combination with the color-contrast base in stainless steel look. The height of the room divider you determine by the number of additional elements as well as the various insert plates, e.g. planter. In combination with the insert plate made of white coated glass, the room divider can even be illuminated, especially as there is a continuous cable channel in the base element for an invisible attachment of the electrical system. All parts are delivered assembled, the individual elements can easily be plugged together.

Individually combinable!

2. If necessary, add an additional element

Available in 4 colors



	LxWxH cm	Weight kg	Color	Ref.	Piece €
5	80.0x25.0x21.5	7	oak	10070602	59,00
6			tobacco	10089141	59,00
7			mocha	10089413	59,00
8			anthracite	10089414	59,00

3. Complete your separation system with the matching inserts

With recess for planters or closed, available in 5 colors

> Insert plate for planter



> Insert plate (closed)



> Planter

Planter DIVISO **4⁹⁹**



> Insert plate made of glass for illumination



	LxWxH cm	Weight kg	Color	Ref.	Piece €	
9	80.0x25.0x3.6	1.3	oak	10089417	19,99	
10			tobacco	10089418	19,99	
11			mocha	10075013	19,99	
12			anthracite	10075032	19,99	
13	Planter	58.5x16.5x14.0	0.4	anthracite	10089420	4,99
14	80.0x25.0x3.6	2.3	oak	10089415	19,99	
15			tobacco	10089416	19,99	
16			mocha	10080334	19,99	
17			anthracite	10080652	19,99	
18	Insert plate made of glass for illumination	76.8x0.4x18.8	1.1	white coated	10089419	19,99



Side table
ESMA
205⁰⁰



■ Max. load capacity
40 kg

Side table ESMA

The frame is made of solid beech wood, the panels are coated with a scratch-resistant melamine coating and equipped with 4 steerable wheels. The brakes on two wheels guarantee a safe parking of the side table.

Material: Beech solid, stained. 4 fully movable wheels, 2 of them with brakes! Melamine coated surface!

	WxDxH cm	Weight kg	Color	Ref.	Piece €
19	71x46x80	13	light brown	10094792	205,00
20	71x46x80	13	dark brown	10094793	205,00

Easy assembly, delivered disassembled.



Coat rack
APENDIO, from
289⁰⁰

Furniture indoor



Coat rack
YARA
89⁹⁹

■ Integrated umbrella stand
■ Solid wood



Find more products at

www.em-group.com



■ Integrated umbrella stand
■ Solid wood

Coat rack APENDIO

This functional coat rack combines high quality and timeless design. Very stable and sturdy thanks to a steel base plate. It has 20 hooks and an umbrella stand made of high-quality stainless steel. Delivered in kit, easy assembly.

Material: Oak natural or tobacco stained, combined with stainless steel.

	WxDxH cm	Weight kg	Color	Ref.	Piece €
22	50x50x180	32	oak natural	30001698	289,00
23	50x50x180	32	tobacco stained	30001699	299,00





Lounger
SEQUENCIO
379⁰⁰

> Table base FINO see p. 345



Your benefit

The three-dimensional joint enables a dynamic and ergonomic posture and offers optimum comfort for your guests.



Sitniss® by **VEGA**

Furniture series SEQUENCIO

Those who sit for a long time should at least sit as well and healthy as possible! Under the claim VEGA Sitniss you will find first-class conference chairs for ergonomic sitting. The focus of this innovative seating furniture is a three-dimensional seat joint, which decouples the rigid connection to the chair base, thus providing micro-movements while sitting, relieving and strengthening the spine. The height-adjustable and easy care chairs and armchairs are available in different colors, covers and foot base versions. Of course, all chair and armchair legs are equipped with plastic gliders. Please choose your seat element fig. 1 - 4 and foot base (fig. 5 - 7).

Fig. 1 - 4: Please order foot base separately.
Material: Imitation leather or fabric: 70% wool, 25% polyamide, 5% other fibers.



6



7



6



5

Conference chair
SEQUENCIO, from
238⁰⁰



8



9

Stool
SEQUENCIO

149⁰⁰



10

- Seat height adjustable
- 2 materials available
- 3 foot bases available

		WxDxH cm (with foot base)	Seat height cm	Weight kg (without foot base)	Material	Color	Ref.	Piece €
1	Seat element with armrest	47x45x 92-94	45-47	12.7	Imitation leather	black	30001683	259,00
2					Fabric	anthracite	30001682	259,00
3	Seat element without armrest	47x45x 92-94	45-47	9.3	Imitation leather	black	30001687	159,00
4					Fabric	anthracite	30001688	159,00

		Weight kg	Material	Color	Ref.	Piece €		
5	Foot base	2.1	Steel	chrome	30001680	79,00		
6		1.7	Aluminum	matt silver	30001677	89,00		
7		1.7	Aluminum	powder-coated black	30001676	89,00		
		WxDxH cm	Seat height cm	Weight kg	Material	Color	Ref.	Piece €
8	Armchair*	56x44x110-120	35-44	16.6	Fabric	anthracite	30001684	499,00
9	Lounger*	56x44x76-85	35-44	10.7	Fabric	anthracite	30001681	379,00
10	Stool*	56x44x35-44	-	6.8	Fabric	anthracite	30001678	149,00

*Incl. foot base.



Table
CONFERENCIO, from
278⁰⁰

Furniture indoor

Create your table for inspiring meetings

Table CONFERENCIO

Our furniture series CONFERENCIO inspires your conference guests with modern design and highest quality. The table system offers a variety of combination possibilities. You have the choice between open and closed table legs. Both variants are either made of high-quality brushed stainless steel or powder-coated steel. The open leg has the additional benefit for your conference guests to sit comfortably on all sides of the table. The table tops are available in two decors: Oak tobacco and oak brown-grey. Thanks to the high quality HPL coating they are robust, scratch-resistant and easy to clean. The impact-resistant ABS edges make the table tops more durable and stable. The mounting of the table tops is simple and safe - this ensure the holes with threaded inserts on the underside of the table tops.

Material: Frame stainless steel brushed or powder-coated steel. Table tops high quality HPL surface.
Easy to clean! Robust! Combinable!

1. Choose a table top

2 colors



	LxWxH cm	Weight kg	Color	Ref.	Piece €
11	180.0x90.0x2.5	30.4	oak tobacco	30014347	149,00
12			oak brown-grey	30014345	149,00

2. Add legs

2 versions - 2 colors

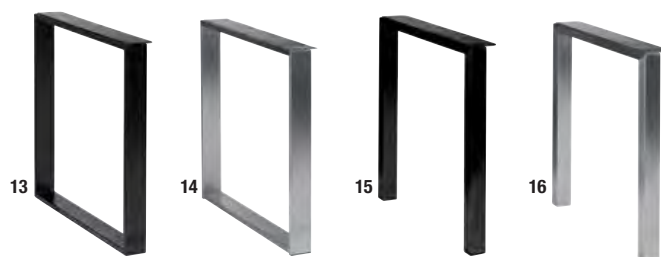

	WxDxH cm	Weight kg	Color	Ref.	Piece €
13	180.0x90.0x74.0	19.0	black-steel	30014348	149,00
14			silver-stainless steel	30014349	249,00
15	180.0x90.0x74.0	20.8	black-steel	30014344	129,00
16			silver-stainless steel	30014346	229,00

Combination possibilities:



Total price: 278,00 €



Total price: 398,00 €

Table top
CONFERENCIO
149⁰⁰



Banquet chair, from
29⁹⁹

Practical chairs for all types of events

■ Stackable

Banquet chair
44⁹⁹



Banquet chair

These practical chairs are ideal for all types of events. They are stackable and have a padded seat and back. The chairs are available with a steel frame in hammered look with red and blue cover or with silver powder-coated frame and black fabric cover. The best: The chairs can be used with matching slip covers for celebrations such as weddings or large banquets.

Cover: 100% polyester. Stackable! Fire retardant!

	WxDxH cm	Seat height cm	Weight kg	Color	Ref.	Pcs./pack	Pack €	Piece €
1	44.5x59.0x92.0	47	5.8	blue	10093928	4	119,96	29,99
2				red	10093930	4	119,96	29,99
3				black	10093720	4	119,96	29,99
4	45.0x61.5x92.5	47	7.7	black	10093812	4	179,96	44,99

Row connector for banquet chairs

With the row connectors made of PVC you can arrange our banquet chairs into rows of chairs. Simply connect the chair legs or armrests with it.

	Suitable for	WxDxH cm	Ref.	Pcs./pack	Set €
5	Fig. 1 – 3	12.0x3.0x3.0	10092111	2	7,98
6	Fig. 4	11.0x3.5x3.0	10099579	2	9,98



Matching slip covers for chairs and tables can be found at

www.em-group.com



Row connector

With the row connectors made of PVC you can arrange our banquet chairs into rows of chairs. Simply connect the chair legs or armrests with it.

Row connector,
from
7⁹⁸





■ Foldable



Banquet table round
199⁰⁰

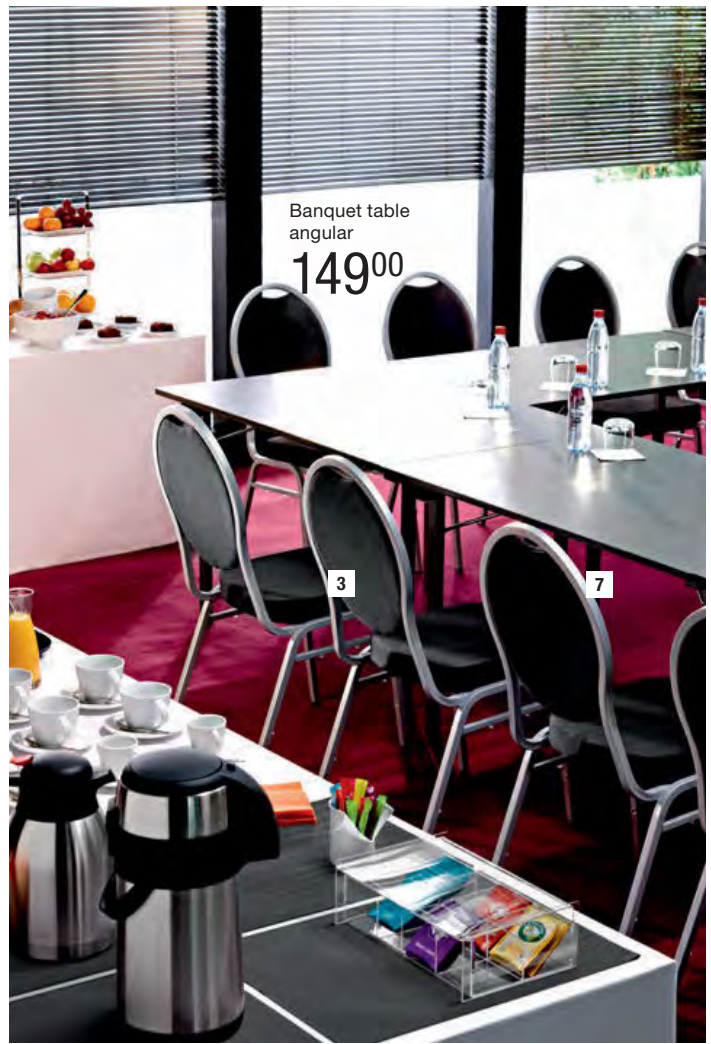

Banquet table angular
149⁰⁰

Furniture indoor

Banquet table

The tables are available in round or angular. The frame is made of sturdy steel pipe, 30x30x1,5 mm, powder-coated in grey hammered look. Table top: 18 mm chipboard melamine coated, available in grey or natural. The tables can be stored space-saving by a simple folding mechanism.

Space-saving! Foldable!

	Shape	Dimension cm	Weight kg	Color	Ref.	Piece €
7	rectangular	WxDxH 120x80x74	19	grey	10091197	149,00
8				beech natural	10091198	149,00
9	round	ØxH 150x74	30	beech natural	10091199	199,00

■ Foldable
■ Easy to clean

Table
KLAPBARO
64⁹⁹



Bar table
KLAPBARO
69⁹⁹

Table and bar table KLAPBARO

KLAPBARO saves space and is easy to set up! The insensitive table top in white or anthracite with plastic edge protection and the sturdy powder-coated steel pipe frame are ideal for everyday use. Foldable, the table needs only 15 cm of space.

Foldable! Easy to clean! 3-year availability guarantee!

		ØxH cm	Weight kg	Color	Ref.	Piece €
10	Table	70x73	8.4	white	30002552	64,99
11				anthracite	30002551	64,99
12	Bar table	70x110	10.5	white	10090213	69,99
13				anthracite	30002534	69,99



Table top
SPESSO, from
69⁹⁹



1

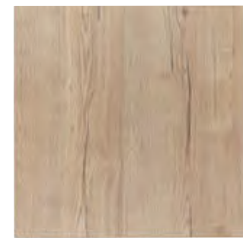

2

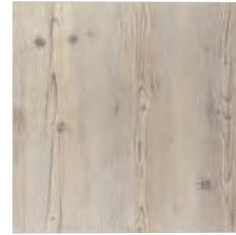

3



4

Table top SPESSO

The table top SPESSO convinces with its natural look and refinement! The table top is made like a laminate table top. However, it has a grain wood edge and a material thickness of 3,8 cm. Its structured surface and natural front sides create a lively surface character. Available in four color versions. Mounting material is included in the table base.

Material thickness 3,8 cm! Shockproof! Abrasion-resistant! Scratch-resistant! Easy to clean! For indoors only!



Table top available in 3 shapes:

round
 square
 rectangular

LxW cm	68x68	80x80	120x80
Weight kg	11.6	16.0	24.0
1 oak smoked	10008425	10008429	10008433
2 oak natural	10008427	10008431	10008435
3 pine natural	10008428	10008432	10008436
4 concrete look	10008426	10008430	10008434
Piece €	69,99	89,99	129,00

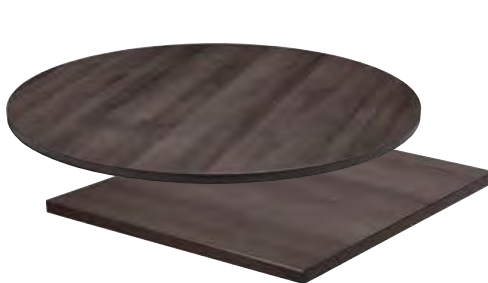

Table top
MALIANA, from
49⁹⁹

5



6



7



8

- Easy to clean
- Many decors



9



10



11



12

Table top MALIANA

The table tops in wood or metal look are almost indestructible. This is ensured on the one hand by the coating: High-quality laminate, which makes the table tops robust and resistant and meets the requirements of DIN EN 438-3: 2005. On the other hand, the table tops are protected by sturdy and impact-resistant, 2 mm thick ABS edges. Mounting material is included in the table base.

Material thickness 2,5 cm! Shockproof! Abrasion-resistant! Scratch-resistant! Easy to clean! For indoors only!

Dimension cm	Ø 60	Ø 80	Ø 100	LxW 60x60	LxW 68x68	LxW 80x80	LxW 80x60	LxW 120x80
Weight kg	5.3	9.4	11.0	6.8	8.6	12.0	8.6	18.0
5 oak tobacco stained	30003927	30003929	30003924	30003903	30003910	30003916	30003890	30003867
6 oak brown-grey	30003926	30003925	30003923	30003901	30003908	30003914	30003888	30003885
7 oak natural	30003928	30003866	30003872	30003902	30003909	30003915	30003889	30003876
8 oak wenge	30003865	30003883	30003877	30003906	30003912	30003900	30003893	30003878
9 pine grey	30003880	30003870	30003879	30003907	30003913	30003918	30003894	30003871
10 pine rustic	30003869	30003884	30003874	30003896	30003898	30003919	30003895	30003887
11 metal antique	30003863	30003881	30003875	30003904	30003897	30003917	30003891	30003868
12 metal rusty	30003864	30003882	30003873	30003905	30003911	30003899	30003892	30003886
Piece €	49,99	69,99	109,00	49,99	59,99	69,99	59,99	99,99



Table top SUMBA

Table tops with fine real wood veneer for an exclusive ambience! Mounting material is included in the table base.

Material thickness 3,5 cm! For indoors only!

Dimension cm	Ø 60	Ø 80	LxW 50x50	LxW 60x60	LxW 70x70	LxW 80x80	LxW 120x80
Weight kg	6.9	10.9	6.1	8.5	10.8	15.3	23.8
13 ash walnut stained	10089619	10089623	10089620	10089621	10089624	10089625	10089529
14 ash black stained	10089611	10089615	10089612	10089613	10089616	10089617	10089618
Piece €	62,99	89,99	52,99	62,99	72,99	89,99	119,00
15 walnut natural	10089855	10089859	10089856	10089857	10089860	10089861	10089862
16 oak natural	10089823	10089827	10089824	10089825	10089828	10089829	10089830
Piece €	72,99	99,99	62,99	72,99	82,99	99,99	139,00

Solid wood table top
TORRES, from

59⁹⁹



- Solid wood
- Scratch-resistant

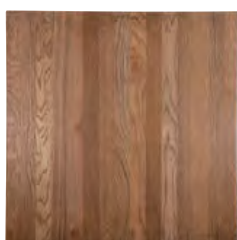

18

■ Solid wood



19

Solid wood table top
KENTUCKY, from

79⁹⁹

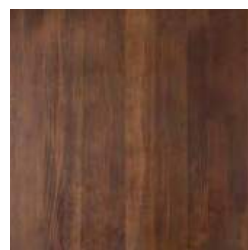

20

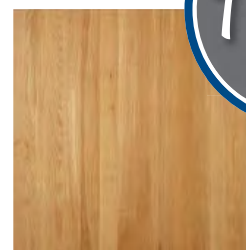

21



Solid wood table top TORRES

In a trendy vintage look, made of solid oak wood. The table tops are matt lacquered and stained, which keeps their natural look and are very easy care - just wipe with a damp cloth! Due to the varnish the surface is scratch-resistant. Mounting material is included in the table base.

Material thickness 3 cm! Metal struts prevent the table top from de-forming! For indoors only! 3-year availability guarantee!

LxW cm	40x40	100x40	60x60	70x70
Weight kg	3.9	9.8	10.0	12.6
17 oak antique	30014280	30014281	10099081	10099083
18 antik oak brown	30014279	30014282	10008491	10008492
Piece €	59,99	115,00	94,99	115,00

LxW cm	80x80	80x60	120x80
Weight kg	15.9	12.5	23.4
17 oak antique	10099085	10099090	10099091
18 antik oak brown	10008493	10008494	10008495
Piece €	145,00	115,00	219,00

Solid wood table top KENTUCKY

Made of solid beech and oak wood. The table tops in natural are treated with an oil-wax, the color tobacco is lacquered. As a result, they keep their natural look and are very easy care - just wipe with a damp cloth. Mounting material is included in the table base.

Material thickness 3 cm! Metal struts prevent the table top from de-forming! For indoors only!

LxW cm	60x60	70x70	80x80	80x60	120x80
Weight kg	8.6	11.5	14.9	11.2	22.2
19 beech natural	10099394	10099395	10099396	10094789	10094790
20 beech tobacco stained	10089630	10089631	10089632	10089633	10089634
Piece €	79,99	99,99	115,00	99,99	169,00
21 oak natural	10099397	10099398	10099399	10094791	10095948
Piece €	94,99	115,00	145,00	115,00	209,00



 More decors can be found at
www.em-group.com

Table top WERZALIT-TOPALIT

Table tops ideal for indoors and outdoors. The table top is simply screwed to the table base. Mounting material is included in the table base.

Material: High density fiber wood with attractive decors. Robust, UV and weather-resistant!

Dimension cm	Ø 60	Ø 80	LxW 60x60	LxW 70x70	LxW 80x80	LxW 110x70
Weight kg	4.2	6.7	3.7	6.7	9.2	10.8
1 black	10091521	10091522	10091623	10091520	10091929	10091624
2 graphite	30040375	30040353	30040337	30040331	30040324	30040354
3 white marbled	30040374	-	30040341	30040318	30040325	30040358
4 oak smoked	30040369	-	30040336	30040316	-	30040346
5 oak tobacco stained	10008991	-	10008993	10008994	-	10008996
6 vintage white	30040373	30040347	30040340	30040322	30040333	30040359
7 light grey	30040371	-	30040342	30040321	-	-
8 pine antique	-	30040349	30040343	30040319	30040332	-
Piece €	34,99	44,99	39,99	49,99	59,99	64,99

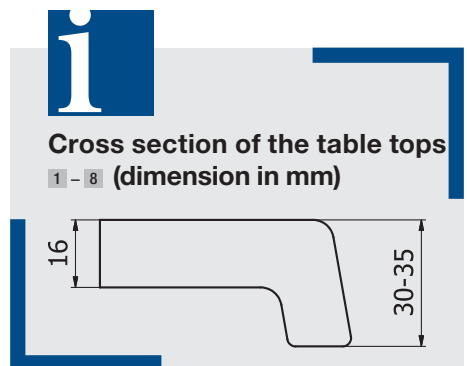

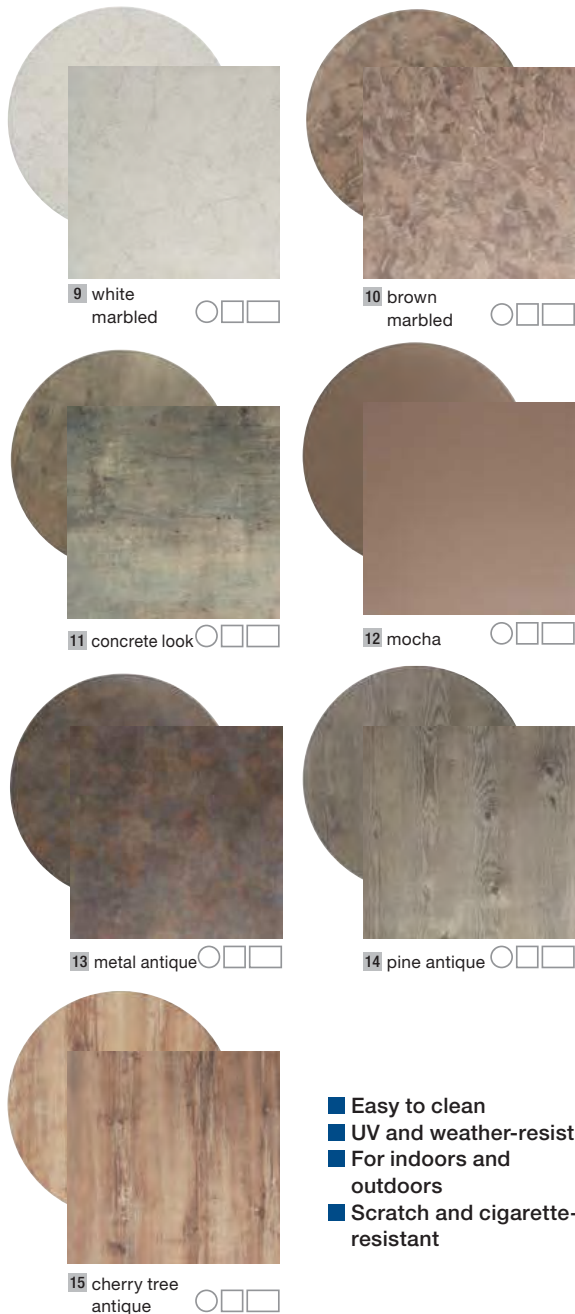

- Easy to clean
- UV and weather-resistant
- For indoors and outdoors
- Scratch and cigarette-glow resistant

i Table top available in 3 shapes:

○ round □ square □ rectangular



Table tops & bases

Table top FINANDO

Versatility and quality: These table tops inspire with their modern design and fit into any ambience with their large choice of decors! They are made of pressed wood chips and sealed watertight - thus they are perfect for indoors and outdoors. With their low material thickness of only 16 mm they look lightweight and filigree. Choose from the shapes round, square or rectangular and several different decors - as it fits your individual style. Note: In strong sunlight especially dark decors can bulge. This process is normal and the original shape is restored as soon as the insolation decreases. Therefore, we recommend bright decors for the outdoors. Our table bases together with the table top sizes recommended by us, meet the requirements for stability. The table top is simply screwed to the table base. Mounting material is included in the table base.

Easy to clean! UV and weather-resistant!

Dimension cm	Ø 70	Ø 80	LxW 70x70	LxW 80x80	LxW 120x80
Weight kg	5.2	6.9	6.7	8.8	12.9
9 white marbled	30014580	30014548	30014566	30014564	30014551
10 brown marbled	30014560	30014552	30014573	30014571	30014543
11 concrete look	30014547	30014557	30014558	30014545	30014554
12 mocha	30014567	30014574	30014576	30014542	30014569
13 metal antique	30014556	30014546	30014553	30014549	30014563
14 pine antique	30014565	30014575	30014578	30014559	30014579
15 cherry tree antique	30014577	30014572	30014550	30014562	30014570
Piece €	54,99	64,99	59,99	69,99	94,99



i Cross section of the table tops 9 - 15 (dimension in mm)



- Scratch-resistant
- UV and weather-resistant

Compact table top
LIFT, from
75⁹⁹

4

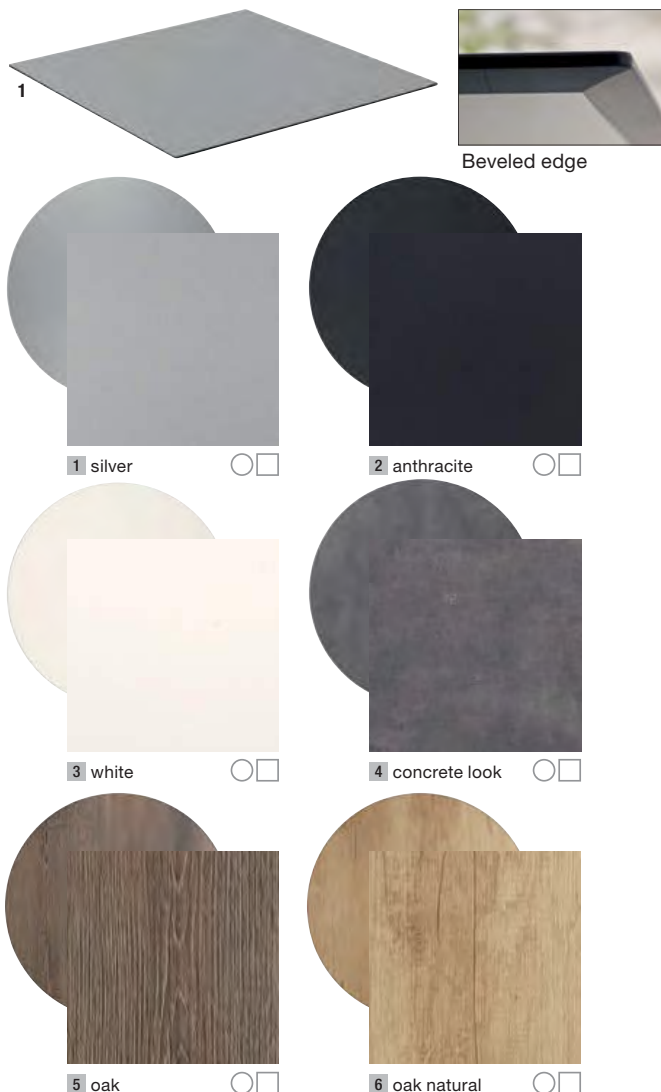

Beveled edge

1 silver

2 anthracite

3 white

4 concrete look

5 oak

6 oak natural



Table top available in 2 shapes:

- round square



Compact table top LIFT

These table tops are absolutely UV and weather-resistant. The surface is very hard and therefore scratch-resistant. The beveled edge makes the 13 mm thick table top very thin. Mounting material especially for these table tops is included. Ideal for indoors and outdoors!

Material: High density laminate.

Dimension cm	Ø 60	Ø 80	LxW 60x60	LxW 68x68	LxW 80x80
Weight	4.8	8.8	6.1	7.8	11.3
1 silver	10094289	10094291	10094286	10094287	10094288
2 anthracite	10094295	10094297	10094292	10094293	10094294
3 white	10094301	10094303	10094298	10094299	10094300
4 concrete look	10094307	10094310	10094304	10094305	10094306
5 oak	10089658	10089662	10089657	10089659	10089661
6 oak natural	10089652	10089656	10089651	10089653	10089655
Piece €	75,99	119,00	75,99	85,99	119,00

*The table top is simply screwed to the table base. Mounting material is included.

Teak table top
LUIGI, from
69⁹⁹

- Solid teak wood



7



8



Teak table top LUIGI

The weatherproof table tops are available with or without aluminum frame. Table top thickness: 2 cm.

Weatherproof! Easy to clean!

LxWxH cm	60x60x2	70x70x2	80x80x2
Weight kg	4.0	4.7	6.3
7 Without aluminum frame	10095061	10095059	10095062
Piece €	69,99	74,99	84,99
LxWxH cm	60x60x2	70x70x2	80x80x2
Weight kg	3.3	4.2	6.0
8 With aluminum frame	10095063	10095060	10095070
Piece €	74,99	79,99	89,99

*The table top is simply screwed to the table base. Mounting material is included in the table base.

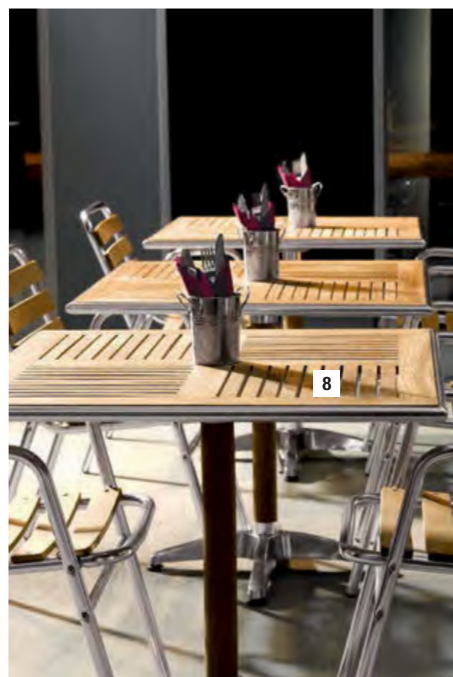

8



9

Table base ARGENTO, from 119⁰⁰

> Table top SUMBA see p. 339



Table base RONDO, from 95⁹⁹

15

> Table base LIFT see p. 342

Table tops & bases

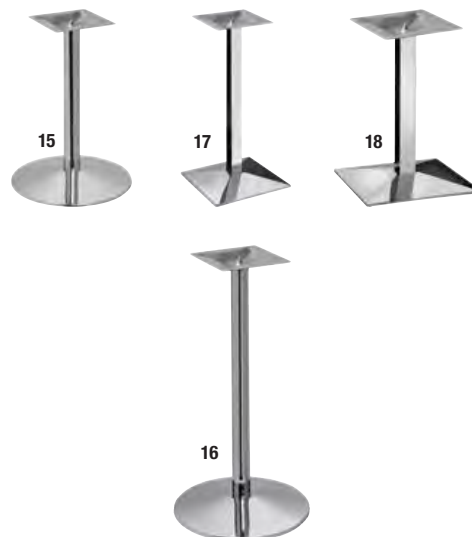
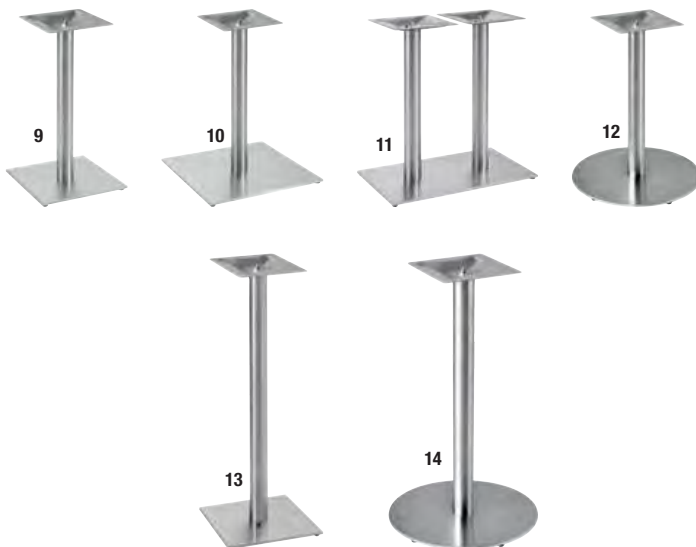

Table base ARGENTO

These table bases - made of high-quality stainless steel - are ideal for any ambience and are suitable for all of our table tops. All table bases include adjusting screws to compensate for ground irregularities. Mounting material for table tops is included. Easy assembly. For indoors and protected outdoor areas.

Material: Stainless steel. 3-year availability guarantee!

	Dimension cm	Max. rec. table top size cm	Weight kg	Ref.	Piece €
9	WxLxH 40.0x40.0x72.0	Ø 80, LxW 60x60	16.7	10089398	119,00
10	WxLxH 55.0x55.0x72.0	Ø 100, LxW 80x80	28.4	10089401	149,00
11	WxLxH 40.0x70.0x72.0	LxW 140x80	29.7	10089402	179,00
12	ØxH 56.0x72.0	Ø 90, LxW 80x80	21.5	10089397	149,00
13	WxLxH 40.5x40.5x108.0	Ø 80, LxW 60x60	19.0	10089400	129,00
14	ØxH 42.5x108.0	Ø 80, LxW 60x60	16.0	10089395	129,00

*Easy assembly, delivered disassembled, incl. mounting material for our table tops.

Table base RONDO and QUADRO

Stability for your tables provide these table bases suitable for every ambience. All table bases include adjusting screws to compensate for ground irregularities. Mounting material for table tops is included. Easy assembly. For indoors and protected outdoor areas.

Material: Steel, chromed. 3-year availability guarantee!

Table base RONDO

	ØxH cm	Max. rec. table top size cm	Weight kg	Ref.	Piece €
15	45x72	Ø 80, LxW 70x70	16.5	10089569	95,99
16	56x72	Ø 90, LxW 80x80	26.9	10089405	105,00
17	56x108	Ø 90, LxW 80x80	24.0	10089403	129,00

Table base QUADRO

	WxLxH cm	Max. rec. table top size cm	Weight kg	Ref.	Piece €
17	42x42x72	Ø 80, LxW 70x70	18.0	10089566	95,99
18	56x56x72	Ø 100, LxW 80x80	26.0	10089567	109,00

*Easy assembly, delivered disassembled, incl. mounting material for our table tops.



Table base
BAROCK
79⁹⁹

Table base

Stability for your tables provide these table bases suitable for every ambience. All table bases include adjusting screws to compensate for ground irregularities.

For indoors and protected outdoor areas. Easy assembly, each table base is delivered disassembled. Mounting material is included in the table base.

Fig. 1 – 19: Cast steel, powder-coated.

Fig. 20 – 27: Steel, powder-coated.

3-year availability guarantee! (fig. 3 – 27).



Table base BAROCK

	ØxH cm	Max. rec. table top size cm	Weight kg	Ref.	Piece €
1 Standard	43x72	Ø 80, LxW 70x70	17	30026298	79,99
2	56x72	Ø 90, LxW 80x80	21	30026297	94,99

Table base
NOSTALGIE, from
64⁹⁹



Table base
SOLENZO, from
64⁹⁹



Table base NOSTALGIE

	WxLxH cm	Max. rec. table top size cm	Weight kg	Color	Ref.	Piece €
3 Standard	42x42x72	Ø 80, LxW 70x70	20.6	white	10089394	74,99
	42x42x72	Ø 80, LxW 70x70		black	10089392	64,99
4 Bar table	42x42x108	Ø 80, LxW 70x70	23.4	black	10089393	74,99

Table base SOLENZO

	WxLxH cm	Max. rec. table top size cm	Weight kg	Ref.	Piece €
5 Standard	44x44x72	Ø 90, LxW 80x80	20.0	10092846	64,99
6	48x80x72	LxW 140x80	26.0	10090060	74,99



Table base
RONDO, from
59⁹⁹

Table base RONDO

	ØxH cm	Max. rec. table top size cm	Weight kg	Ref.	Piece €
11 Standard	43x72	Ø 80, LxW 70x70	15.5	10093959	59,99
	55x72	Ø 90, LxW 80x80	24.8	30040106	74,99
12 Bar table	43x108	Ø 80, LxW 70x70	16.5	10089556	74,99

Table base
PYRAMIDE, from
59⁹⁹

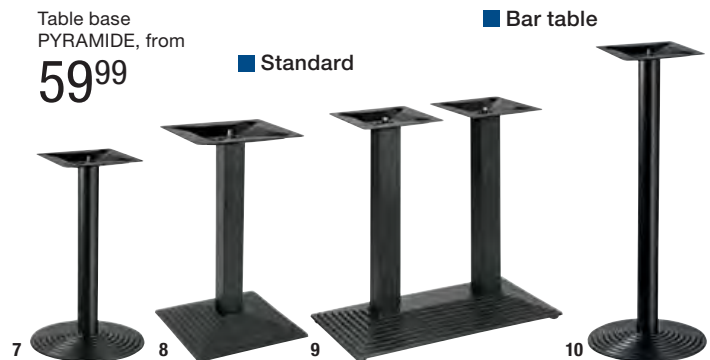

Table base PYRAMIDE

	Dimension cm	Max. rec. table top size cm	Weight kg	Ref.	Piece €
7	ØxH 42x72	Ø 80, LxW 60x60	17.0	10089558	59,99
	ØxH 55x72	Ø 90, LxW 80x80	24.0	10089562	69,99
8 Standard	WxLxH 42x42x72	Ø 80, LxW 70x70	15.9	10089560	59,99
	WxLxH 55x55x72	Ø 100, LxW 80x80	27.0	30040105	69,99
9	WxLxH 40x80x72	LxW 140x80	26.8	30040108	119,00
10 Bar table	ØxH 42x108	Ø 80, LxW 60x60	18.0	10089559	74,99



Table base QUADRO

	WxLxH cm	Max. rec. table top size cm	Weight kg	Color	Ref.	Piece €
13 Standard	42x42x72	Ø 80, LxW 70x70	18.1	white	10089571	69,99
				black	10093958	59,99
14	55x55x72	Ø 100, LxW 80x80	27.8	white	30040117	79,99
				black	30040179	69,99
15	40x80x72	LxW 140x80	26.8	black	30040109	119,00
16 Bar table	42x42x108	Ø 80, LxW 70x70	19.4	black	10093957	79,99
	55x55x108	Ø 100, LxW 80x80	28.2	black	30040104	89,99

Table base
KREUZ
54⁹⁹



■ With 2 legs

Table base KREUZ

	WxLxH cm	Max. rec. table top size cm	Weight kg	Ref.	Piece €
17 Standard	84x84x72	Ø 90, LxW 80x80	13.2	30040107	54,99

Table base DUO

	WxLxH cm	Max. rec. table top size cm	Weight kg	Ref.	Piece €
18 Standard	55x11x72	LxW 120x80	2 x 8.7	10089575	74,99
19 Standard	54x6x72	LxW 140x80	2 x 9.7	10089561	74,99



> Table top SUMBA see p. 339

Table tops & bases

Lounge table base
FINO
64⁹⁹



■ Lounge



■ Standard



■ Bar table

Table base FINO

	Dimension cm	Max. rec. table top size cm	Weight kg	Ref.	Piece €
20 Lounge	ØxH 43x45	Ø 80, LxW 60x60	16.0	10089591	64,99
21 Lounge	WxLxH 40x40x45	Ø 80, LxW 70x70	18.0	10089592	64,99
22 Standard	ØxH 43x72	Ø 80, LxW 70x70	17.0	10089587	69,99
23 Standard	WxLxH 43x43x72	Ø 90, LxW 80x80	18.0	10089585	69,99
24 Standard	WxLxH 40x70x72	LxW 140x80	32.0	10089589	109,00

	Dimension cm	Max. rec. table top size cm	Weight kg	Ref.	Piece €
25	HxØ 108x43	Ø 80, LxW 70x70	18.0	10089588	79,99
26 Bar table	WxLxH 43x43x108	Ø 90, LxW 80x80	19.5	10089586	79,99
27	WxLxH 40x70x108	LxW 140x80	34.5	10089590	129,00

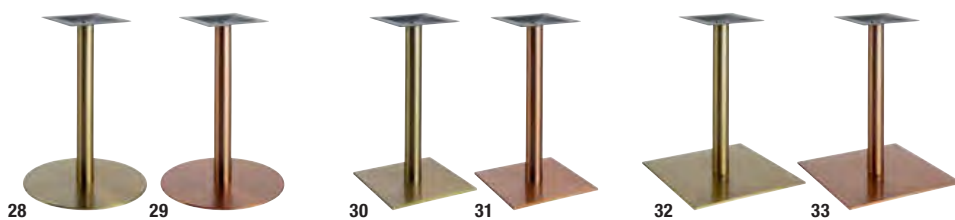

Table base ORIO

These table bases are of special attention - they are made of stainless steel and can be combined in the current trend colors copper or gold lacquered with all of our table tops. All table bases include adjusting screws to compensate for ground irregularities. Mounting material for table tops is included. For indoors and protected outdoor areas.

Material: Stainless steel, lacquered.

	Dimension cm	Max. rec. table top size cm	Weight kg	Color	Ref.	Piece €
28	ØxH 54x72	Ø 90, LxW 80x80	17.2	gold	30002404	159,00
29				copper	30002415	159,00
30	WxLxH 40x40x72	Ø 80, LxW 60x60	13.5	gold	30002414	129,00
31				copper	30002408	129,00
32	WxLxH 55x55x72	Ø 100, LxW 80x80	22.0	gold	30002409	159,00
33				copper	30002405	159,00



Table base
ORIO, from
129⁰⁰

29



Table base
FLEKSO, from
179⁰⁰

2



Table base
SCUDO, from
119⁰⁰

- Foldable
- Space-saving
- Twin base available

3



4

5

6

Table base SCUDO

Thanks to a special construction, the table legs can be placed together, and the foldable table cross is extremely space-saving. Suitable for all table tops from our range.

Material: Aluminum, powder-coated. For indoors and outdoors! UV and weather-resistant! Incl. adjusting screws to compensate for ground irregularities! Foldable! Space-saving!

	WxLxH cm	Max. rec. table top size cm	Weight kg	Color	Ref.	Piece €
3	52.0x48.0x70.5	Ø 80, LxW 80x80	5.8	silver	10093367	119,00
4				anthracite	10093368	119,00
5	52.0x87.0x71.0	LxW 120x80	8.8	silver	10094778	185,00
6				anthracite	10094779	185,00

*Easy assembly, delivered disassembled. Incl. mounting material for table tops.



- Height differences of up to 20 cm compensable
- No problem with strong slope and stairs
- Patented system by VEGA

■ Bar table

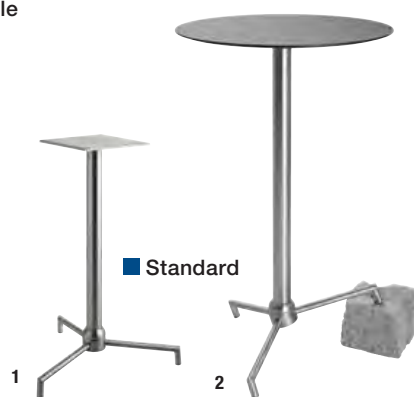

■ Standard

1

2



Table base FLEKSO

Wobbly tables are now a thing of the past! The new table base FLEKSO compensates any unevenness or gradient in the ground quickly, easily and very confidently. This is ensured by a ball joint system patented by VEGA, which makes the flexible adjustment of the table base extremely easy. By turning the table top clockwise and counterclockwise, the mechanism is tightened or released. Optionally available for tables or bar tables. Suitable for all table tops from our range.

Material: Stainless steel, brushed. Flexible adjustment by patented system by VEGA (ball joint)! Weatherproof! For indoors and outdoors.

	WxLxH cm	Max. rec. table top size cm	Weight kg	Ref.	Piece €
1 Standard	55x55x73	Ø 70	5.4	10008507	179,00
2 Bar table	55x55x109	Ø 70	6.2	10008506	199,00

*Easy assembly, delivered disassembled. Incl. mounting material for table tops.

Table base
KROMO, from
99⁹⁹

■ With 2 legs



7

8



Table bases KROMO

Our stainless steel table bases combine stability with modern appearance and are suitable for indoors well as for outdoors. Suitable for all table tops from our range. Ref. 10089577 only suitable for rectangular table tops from 110x70 cm to 140x80 cm.

Material: Stainless steel, brushed. Incl. adjusting screws to compensate for ground irregularities! For indoor and outdoors! UV and weather-resistant!

	WxLxH cm	Max. rec. table top size cm	Weight kg	Ref.	Piece €
7	43x43x74	Ø 80, LxW 60x60	6.2	10089576	99,99
8	63x95x74	LxW 140x80	14.0	10089577	129,00

*Easy assembly, delivered disassembled. Incl. mounting material for table tops.

Table base
TAIPA, from
74⁹⁹

- Foldable
- Space-saving
- Standard
- Bar table



Table base TAIPA

Stable aluminum and additional weights give the table base the necessary stability. The staggered shape of the base cross and the foldable table cross enable a space-saving arrangement of several tables. Suitable for all table tops from our range.

Material: Aluminum, brushed. Incl. adjusting screws to compensate for ground irregularities! For indoors and outdoors! Space-saving! Foldable! Weatherproof! 3-year availability guarantee!

	WxLxH cm	Max. rec. table top size cm	Weight kg	Ref.	Piece €
9 Standard	66x66x72	Ø 80, LxW 70x70	7.0	10095048	74,99
10 Bar table	66x66x108	Ø 80, LxW 70x70	7.7	10009333	94,99

*Easy assembly, delivered disassembled. Incl. mounting material for table tops.

Table base
LUIGI, from
49⁹⁹

- Foldable
- Lightweight



Table base LUIGI

The aluminum table bases are ideal for outdoors. To protect the table tops and to save space, the table tops can be folded by 90°. The column of Ref. 10090597 is additionally covered with teak wood. Suitable for all table tops from our range.

For indoors and outdoors! Space-saving! Lightweight! Aluminum thickness 2 mm! Incl. adjusting screws to compensate for ground irregularities!

	WxLxH cm	Max. rec. table top size cm	Color	Weight kg	Ref.	Piece €
11 Standard	42x42x68	Ø 60, LxW 60x60	Aluminum	4.0	10090596	49,99
12			Teak	4.5	10090597	54,99

*Easy assembly, delivered disassembled. Incl. mounting material for table tops.

Table base
ANEGO
74⁹⁹

- Foldable



Table base ANEGO

The table base made of aluminum is ideal for outdoors. To protect the table tops and to save space, the table tops can be folded by 90°. Suitable for all table tops from our range.

Material: Aluminum, brushed. For indoors and outdoors! UV and weather-resistant! Incl. adjusting screws to compensate for ground irregularities! 3-year availability guarantee!

	WxLxH cm	Max. rec. table top size cm	Weight kg	Ref.	Piece €
13 Standard	45x45x72	Ø 80, LxW 70x70	7.5	10094663	74,99

*Easy assembly, delivered disassembled. Incl. mounting material for table tops.



Table base
ADRIANO, from
109⁰⁰

> Table base LIFT see p. 342

- Foldable
- Space-saving
- Also available in bar table height

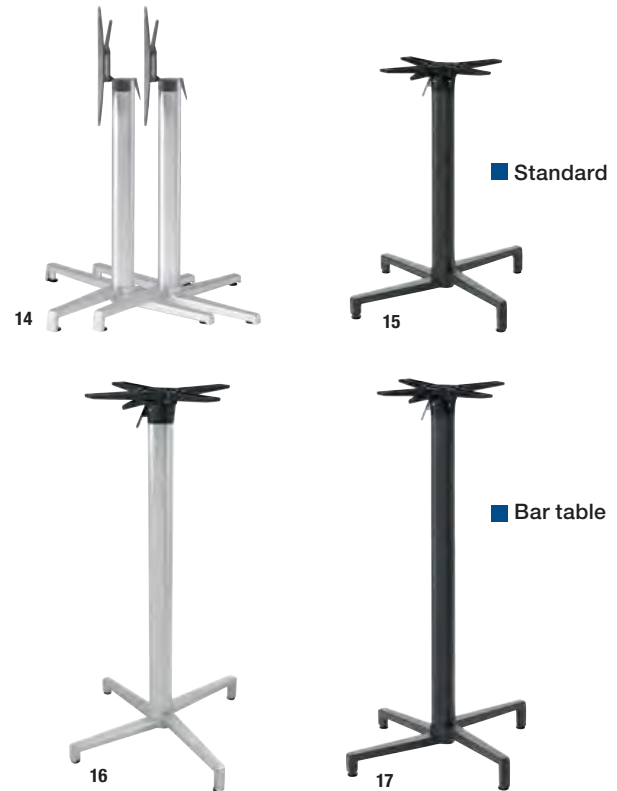

Table base ADRIANO

High-quality table base made of weatherproof, powder-coated aluminum. The table legs can be placed together and the table cross is foldable. Suitable for all table tops from our range.

Material: Aluminum, powder-coated. For indoors and outdoors! Foldable! UV and weather-resistant! Space-saving! Incl. adjusting screws to compensate for ground irregularities! 3-year availability guarantee!

	WxLxH cm	Max. rec. table top size cm	Weight kg	Color	Ref.	Piece €
14 Standard	48x53x73	Ø 80, LxW 70x70	5.0	silver	10094646	109,00
15				anthracite	10094508	109,00
16 Bar table	48x53x109	Ø 80, LxW 70x70	5.4	silver	10094801	129,00
17				anthracite	10094800	129,00

*Easy assembly, delivered disassembled. Incl. mounting material for table tops.



Flat® technology

The annoying wobble at indoor and outdoor tables finally comes to an end. This is made by the special patented Flat® technology. The hydraulic floor gliders adjust perfectly to any uneven ground. Thus, several tables can be aligned quickly and easily in the height next to each other. Simply align the tables in the desired position. The lock takes place by itself.



- Hydraulic floor gliders
- The table base automatically adjusts to uneven grounds
- Simple aligning of several tables next to each other in the same height
- The lock is made after aligning the desired position by itself



- Flat® technology
- Automatic adjustment



- Foldable

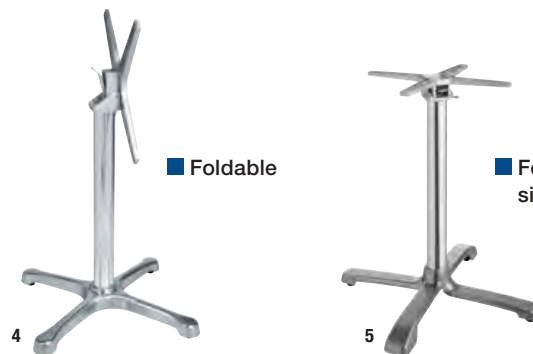

- Foldable and side stackable



Table base REGULO made of aluminum

The table base with hydraulic floor gliders guarantees stable tables at all times. It is also possible to align several tables next to each other. The models fig. 4 - 6 are foldable and thus save space.

Material: Aluminum or cast iron (fig. 6), with plastic gliders.

**For indoors and outdoors.
3-year availability guarantee!**

	WxLxH cm	Max. rec. table top size cm	Weight kg	Color	Ref.	Piece €
1	49.0x49.0x72.0	Ø 80, LxW 70x70	4.5	silver	10094447	109,00
2				anthracite	10097696	114,00
3	49.0x49.0x103.5	Ø 80, LxW 70x70	6.0	silver	10008487	135,00
4 Foldable	49.0x49.0x72.0	Ø 80, LxW 70x70	4.5	silver	10094645	134,00
5 Foldable and side stackable	51.0x51.0x72.0	Ø 80, LxW 70x70	4.8	silver	10008485	149,00
6				black	10008486	149,00

*Easy assembly, delivered disassembled. Incl. mounting material for table tops.



> Table top LIFT see p. 342

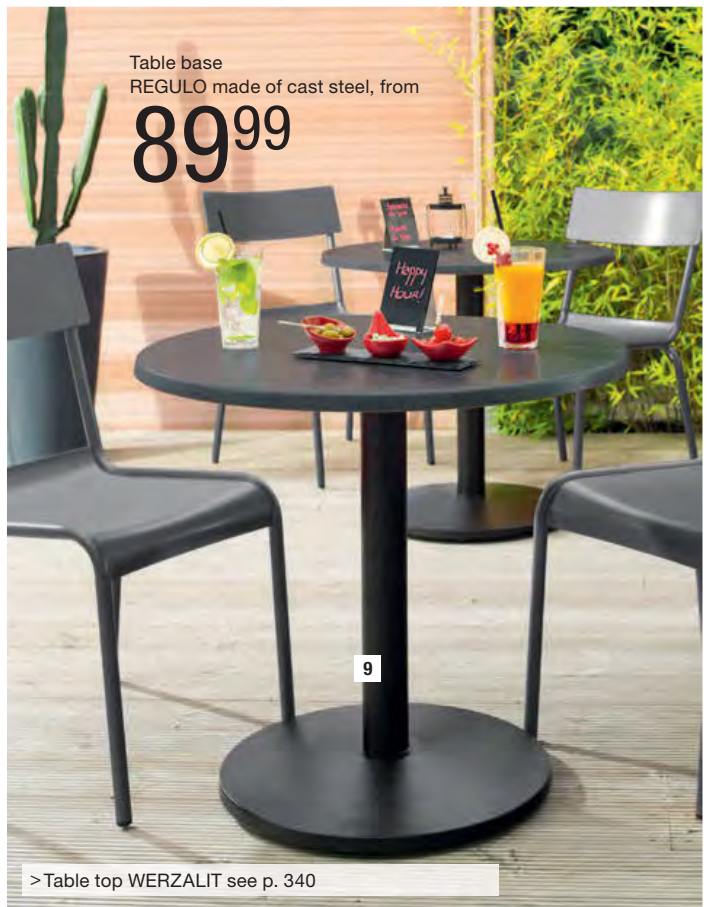

> Table top WERZALIT see p. 340

Table tops & bases



Matching table tops see p. 338-342 and at

www.em-group.com



7



8



9

- Flat® technology
- Automatic adjustment

■ With 2 legs



10



11



12



Table base REGULO made of cast steel

This table base with hydraulical floor gliders adjusts perfectly to any uneven ground. Thus, several tables can be aligned quickly and easily in the height next to each other. Simply align the tables in the desired position, the lock takes place by itself.

Material: Cast steel, powder-coated, with plastic gliders.

For indoors and protected outdoor areas. 3-year availability guarantee!

	Dimension cm	Max. rec. table top size cm	Weight kg	Ref.	Piece €
7 NOSTALGIE	WxLxH 57.0x57.0x72.0	Ø 90, LxW 80x80	17	30003095	119,00
8 Square	WxLxH 40.0x40.0x72.0	Ø 70, LxW 70x70	13	10008489	105,00
9 Round	ØxH 55.0x72.0	Ø 80, LxW 70x70	18	10094448	109,00
10 Double	WxLxH 56.0x13.0x72.0	LxW 120x80	2x 8	10095946	114,00
11 Cross	WxLxH 57.0x56.0x72.0	Ø 90, LxW 80x80	12	10094449	89,99
12	WxLxH 57.0x57.0x103.5	Ø 90, LxW 80x80	13	10008488	119,00

*Easy assembly, delivered disassembled. Incl. mounting material for table tops.



+49 8272 807 447



service@em-group.com



www.em-group.com

AVENTURO

A clearing trolley that can be assembled according to your wishes. AVENTURO impresses with design and function! With the help of the cross struts (included in the scope of delivery) you can safely transport bottles, glasses and much more on the first and second floor. The separately orderable shelves, GN containers 1/1 and the cutlery holder can be used flexibly - exactly as you need. The frame is made of matt powder-coated aluminum, the shelves are made of plastic. This makes AVENTURO robust and weatherproof, making it perfect for outdoor use. The wheels with parking brake need to be ordered separately and provide you with the necessary flexibility.

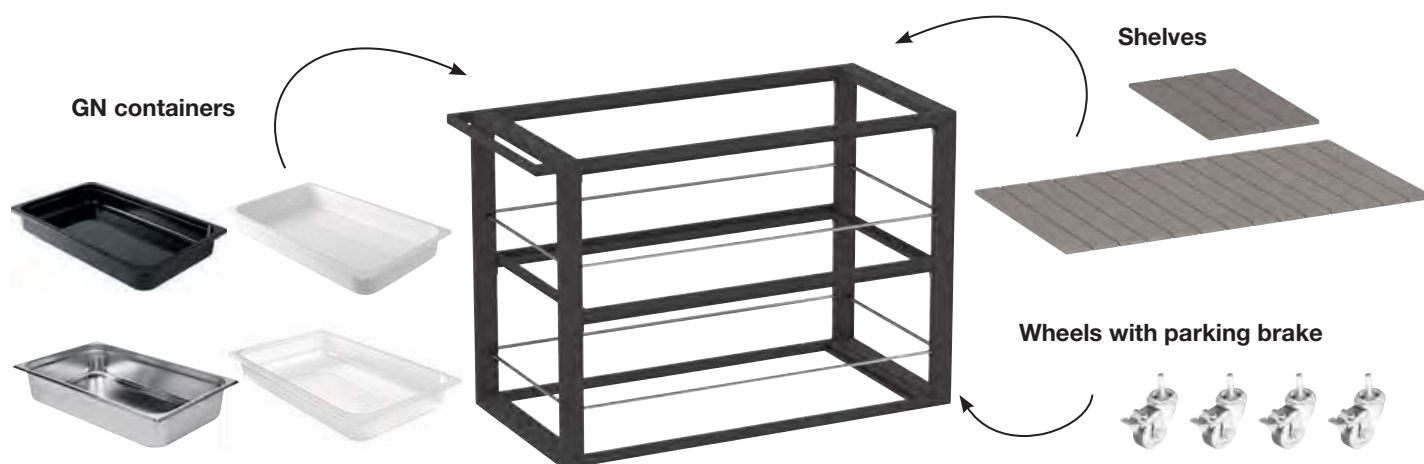

Clearing trolley
AVENTURO, from

279⁹⁵

- Suitable for outdoors
- Combinable
- Stable and robust

> All items of the clearing trolley
AVENTURO see p. 352

AVENTURO

✚ GN size: Combine AVENTURO with your GN containers!

A tailor-made clearing trolley for you!

✚ Individually configurable: Stay flexible.



✚ UV-resistant and weatherproof: Just let it stand outside!

AVENTURO – combine individually



Clearing trolley AVENTURO

With its high-quality frame made of matt powder-coated aluminum and shelves made of sturdy plastic, it is extremely stable, UV and weather-resistant and extremely easy care. Stable cross struts (included in the scope of delivery) can be used on the 2nd and 3rd floor for a safe transport of bottles, crockery and much more. Also various GN containers and a cutlery container can be used accurately. This makes this clearing trolley extremely flexible and is the perfect support in your everyday life. Frames and shelves can be individually combined in color with many of our existing chairs and tables. AVENTURO is the best choice for your modern indoor and outdoor ambience.

Made of matt powder-coated aluminum, shelves made of plastic in wood look, cutlery holder made of polypropylene. Suitable for outdoors! 3-year availability guarantee!

1. Choose for the top two levels

> 1 shelf



> Or from these 5 parts



■ GN containers in 3 different materials available

> More GN versions see p. 476-479

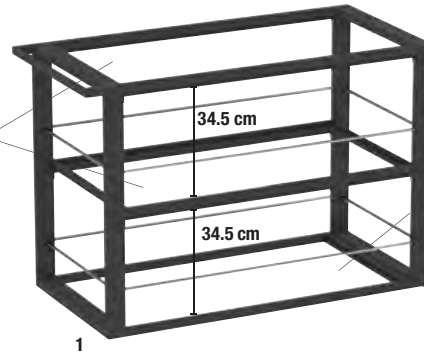

■ Individually configurable
■ UV and weather-resistant

2. Add one shelf as floor



3. Mount the wheels



	WxDxH cm	Color	Ref.	Piece €
1 Frame*	119.0x56.0x88.8	anthracite	10080377	99,99
2 Shelf	97.5x53.0x3.0	grey	10080378	49,99
3 Shelf	53.0x32.5x3.0	grey	10080410	29,99
4 Wheel set 4-piece (incl. mounting material)	–	–	10080421	29,99

	LxWxD cm	Material	Color	Ref.	Piece €
5	53.0x32.5x6.5	Melamine	white	10006315	29,99
6 Gastronorm container			black	10006324	29,99
7 1/1 GN		Polypropylene	–	10010359	9,59
8		Stainless steel 18/10	–	10081630	14,99

*Frame delivered disassembled, incl. mounting material. Max. load capacity per shelf: 40 kg.

Combination possibilities:



Total price: 319,93 €



Total price: 304,93 €



Total price: 359,91 €

Cutlery holder AVENTURO

39,99



Cutlery holder AVENTURO
Made of polypropylene. GN 1/1.

	WxHxD cm	Ref.	Piece €
9	53.0x9.0x32.5	10080423	39,99



Complete set

Save money with our clearing trolley complete set.

Buy the ready-made set with a single item number and benefit from our attractive price offer compared to the purchase of the individual parts.

Clearing trolley complete set AVENTURO

Consisting of:

- 1x frame
- 2x shelf (97.5x53.0x3.0 cm)
- 2x shelf (53.0x32.5x3.0 cm)
- 1x wheel set 4-piece
- 1x cutlery holder

	WxHxD cm	Ref.	Piece €
10	119.0x88.8x56.0	30022038	299,00



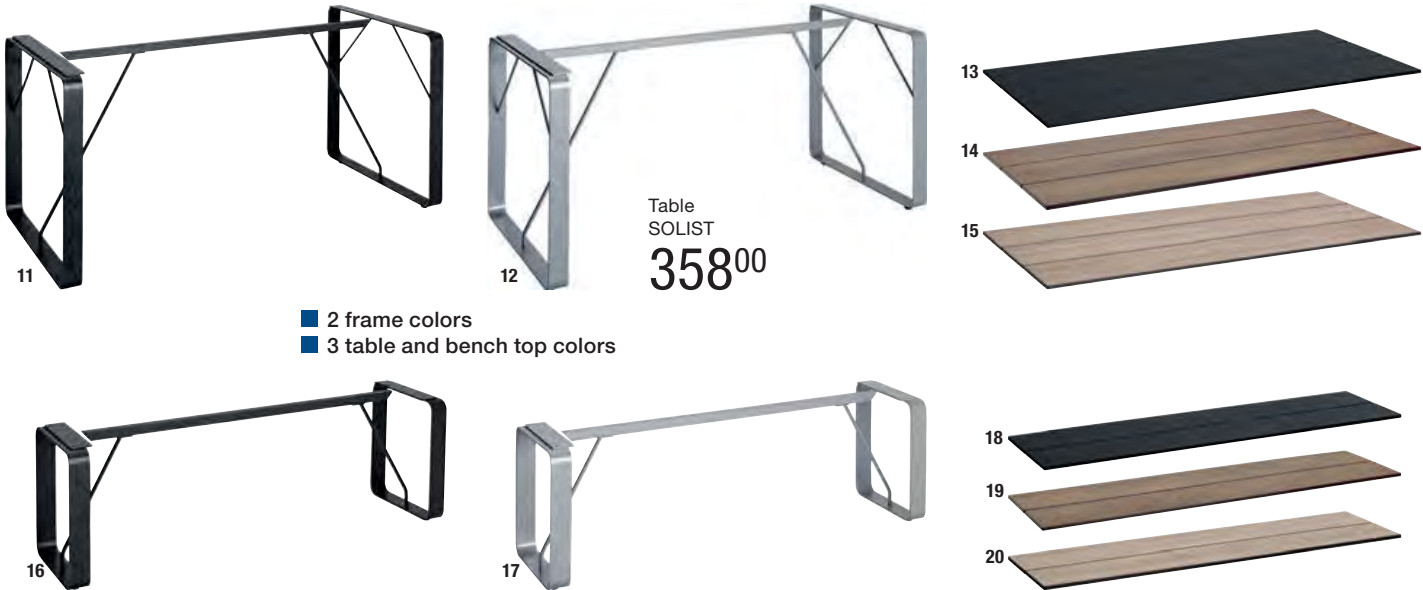

- 2 frame colors
- 3 table and bench top colors

Furniture series SOLIST

Combine the available frames made of absolutely weather-resistant, galvanized and powder-coated steel with the existing table and bench tops. These consist of high-quality compact laminate in modern and easy to clean decors. The upper side of the top is divided by narrow milled sections, resulting in a harmonious appearance. The benches can be pushed under the tables to save space and can also be linked theft-proof (see p. 400). Mounting material for the table top is included in the frame.

**Weatherproof! Individually combinable!
3-year availability guarantee!**



	LxWxH cm	Weight kg	Color	Ref.	Piece €
11	160.0x75.0x73.0	40.0	anthracite	10094774	159,00
12			silver	10094775	159,00
13	160.0x75.0x1.3	19.4	anthracite	10094796	199,00
14			oak smoked	10089899	199,00
15			oak	10094797	199,00
16	139.0x36.0x44.0	21.6	anthracite	10094776	89,99
17			silver	10094777	89,99
18	139.0x36.0x1.3	8.3	anthracite	10094798	109,00
19			oak smoked	10089900	109,00
20			oak	10094799	109,00

Easy assembly, delivered disassembled.

Seat cushion
VINCENT

8⁴⁹



Seat cushion VINCENT

Suitable for chair ARTLESS. The cover can be easily removed from the foam filling by a zipper. With non-slip PVC underside. More colors see p. 362.

Cover: 100% polyester. 30 °C washable.

Filling: Polyurethane foam.

Water-repellent and UV-resistant!

Removable!

	WxDxH cm	Color	Ref.	Piece €
1	40x40x3	ecru	10082778	8,49
2		berry	10082776	8,49
3		apple green	10082773	8,49
4		anthracite	10082774	8,49

Bench cushion
ARTLESS

19⁹⁹



Bench cushion ARTLESS

Suitable for bench ARTLESS. The cushion is fastened to the middle slat of the bench with 3 straps.

Cover: 100% polyester. 30 °C washable.

Filling: Polyurethane foam.

Water-repellent and UV-resistant!

Removable!

	LxWxH cm	Color	Ref.	Piece €
5	144.0x34.0x3.5	ecru	10089342	19,99
6		berry	10089341	19,99
7		apple green	10089339	19,99
8		anthracite	10089340	19,99

Care spray
ARTLESS

10⁹⁹



9

Care spray for furniture series ARTLESS

Optimum cleaning agent for imitation wood made of plastic. Cleans, cares and protects. Also ideal for wood, ceramics, brass, bronze, copper, chrome and stainless steel. Apply the spray to a dry, lint-free cloth and clean the surface evenly, then polish again.

	Content ml	Ref.	Piece €
9	300	10082882	10,99



Barstool
ARTLESS

64⁹⁹

Lightweight aluminum

Bar table
ARTLESS

179⁰⁰



10



11



Furniture series ARTLESS

A refined combination of materials: Bench, table, barstool, bar table and chair of this series are made of aluminum in stainless steel look with plastic slats - and thus UV and weather-resistant. Thanks to a special coating, the plastic panels are particularly easy care and scratch-resistant. Up to 5 chairs are stackable - a real space benefit in storage.

Material: Aluminum in stainless steel look. Slats: Plastic.

Easy to clean! UV-resistant! Suitable for outdoors! Chair stackable! 3-year availability guarantee!



Furniture outdoor

3-seater bench
ARTLESS
139⁰⁰

- Imitation wood
- UV-resistant
- Chair stackable

Chair
ARTLESS
91⁹⁹



Table
ARTLESS, from
159⁰⁰



	Dimension cm	Weight kg	Ref.	Pcs./pack	Pack €	Piece €
10 Bar table*	LxWxH 72.0x72.0x110.0	11.0	10094884	1	-	179,00
11 Barstool	WxDxH 34.0x34.0x76.0	3.0	10094885	2	129,98	64,99
12 3-seater bench*	LxWxH 144.0x34.0x45.0	8.5	10094882	1	-	139,00
13 Chair (seat height 43.5 cm)	WxDxH 55.0x57.5x89.0	5.0	10094886	2	183,98	91,99

	Dimension cm	Weight kg	Ref.	Pcs./pack	Pack €	Piece €
14	LxWxH 80.0x72.0x75.0	8.0	10095276	1	-	159,00
15 Table*	LxWxH 120.0x72.0x75.0	12.0	10095275	1	-	189,00
16	LxWxH 160.0x72.0x75.0	16.5	10094883	1	-	219,00

*Easy assembly, delivered disassembled.

Design your terrace with the modular LIKA furniture

Lounge series LIKA

The lounge furniture LIKA consists of three individual elements, which can be combined quickly and easily into a complete lounge world. The rounded wickerwork can be combined with the cushions COMBINE. All elements are stackable through a cut-out in the seat, which facilitates storage over the winter. The height of the sturdy legs simplifies cleaning under the seats and the element without backrest can be used as a table and as a stool.

Material: Aluminum frame with polyethylene wickerwork. UV-resistant! Easy to clean! Stackable!



Cushion & all-weather cushion COMBINE

The polyester cover is made of mottled effect material. Seat cushion (fig. 4 - 6, 13, 14) with special non-slip coating on the back.

Cushion cover: 100% polyester. 30 °C washable.

All-weather cushion cover: 100% polypropylene. 30 °C washable.

Special Quick-Dry-Foam® technology! Water-repellent and UV-resistant! Removable!

1. Choose a base element

3 models available!



Table/Stool
LIKA
89⁹⁹

1



2



3

- UV-resistant
- Stackable
- Easy to clean

	WxDxH cm	Seat height cm	Weight kg	Ref.	Piece €
1 Table/Stool	69.5x69.5x31.0	–	4.7	30001425	89,99
2 Middle element	76.5x76.5x64.0	31	8.9	30001429	129,00
3 Corner element	76.5x76.5x64.0	31	9.3	30001428	169,00

2. Add a cushion

5 colors available

■ Water-repellent

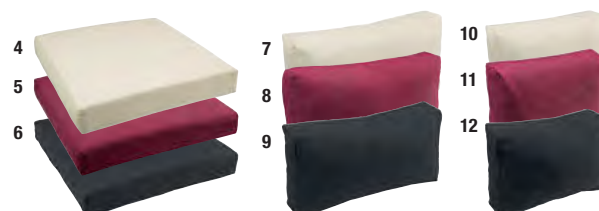

- Weather-resistant
- Quick-Dry-Foam® technology

Cushion
COMBINE, from
26⁹⁹



	Seat cushion	Back cushion	Side cushion
WxDxH cm	70x70x11	70x21x40	49x21x40
off-white	4 10089320	7 10089322	10 10089321
blackberry	5 10089314	8 10089316	11 10089315
anthracite	6 10089308	9 10089310	12 10089309
Piece €	42,99	32,99	26,99

	All-weather cushion	All-weather back cushion	All-weather side cushion
WxDxH cm	70x70x11	70x21x40	49x21x40
natural mottled	13 10089354	15 10089355	17 10089356
black mottled	14 10089359	16 10089360	18 10089361
Piece €	61,99	41,99	31,99

3. Use the row connectors to connect the elements



Row connector
LIKA
4⁵⁸

19

	LxWxH cm	Ref.	Set €
19 Row connector (2-piece)	6.5x4.0x4.0	30001426	4,58

4. Complete with a table

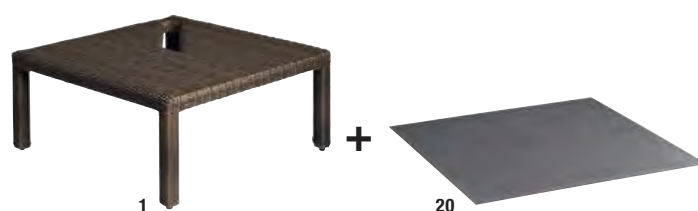

1

20

	LxWxH cm	Weight kg	Ref.	Piece €
20 Table top	69.5x69.5x0.5	5.4	10089599	82,99



Middle element
LIKA

129⁰⁰

Furniture outdoor

Combination possibility:

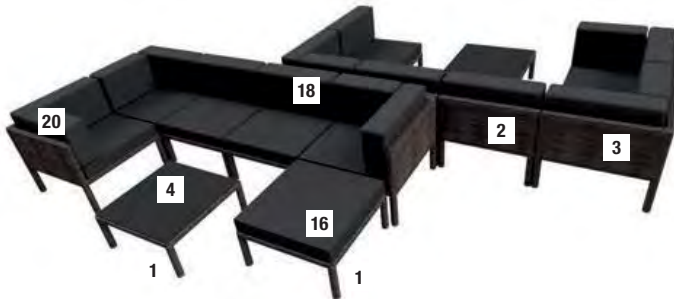

Cushion box
MALACCA

- UV-resistant
- Waterproof

359⁰⁰

Cushion box MALACCA

Two gas springs allow easy opening of the lid. Transparent plastic panels inside the box protect your cushions against rain. The box can be easily secured with our wire rope (see p. 400). Inside dimension: 109.0x49.5x72.0 cm.

Material: Aluminum frame with high-density polyethylene wickerwork. Weatherproof! UV-resistant! Protects cushions from rain water! Gas springs for easy opening! No assembly required!

	LxWxH cm	Weight kg	Color	Ref.	Piece €
21	110x52x81	27.5	dark taupe	10094768	359,00
22			tobacco	10094767	359,00



Create an individual lounge area with the series COMBINE



Lounge series COMBINE

This lounge series made of high-quality brand wickerwork is maximum combinable and suitable for indoors and outdoors. Particularly durable and UV-resistant, this series offers many benefits: The basic element is - in three attractive colors - the basic element for all shapes. With a connecting element (fig. 3) you can connect it as you like to a lounge or couch. Up to 3 side elements can be attached to each base element. The base element can also be used with the table top (fig. 21) as a lounge table. The sturdy aluminum frame stands on high-quality feet with panels made of stainless steel. For a lounge corner please order a back and a side cushion. Mounting material is included in the side element.

Material: Aluminum frame with high-density polyethylene wickerwork.

Table top: HPL laminate.

Durable and UV-resistant! Weatherproof! Legs in stainless steel! Individually usable! 3-year availability guarantee!

1. Choose a base element

2 colors available

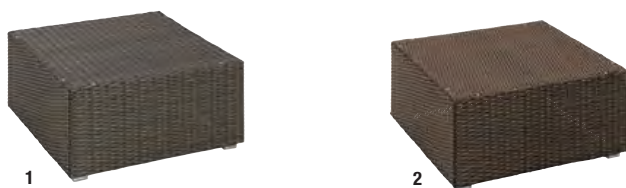

	WxDxH cm	Weight kg	Color	Ref.	Piece €
1	70.0x70.0x32.0	5.0	dark taupe	10089668	125,00
2			tobacco	10089669	125,00

2. Use the row connector



	WxDxH cm	Ref.	Set €
3	6.5x4.0x4.0	10099679	4,98

3. Add matching cushions

5 colors available

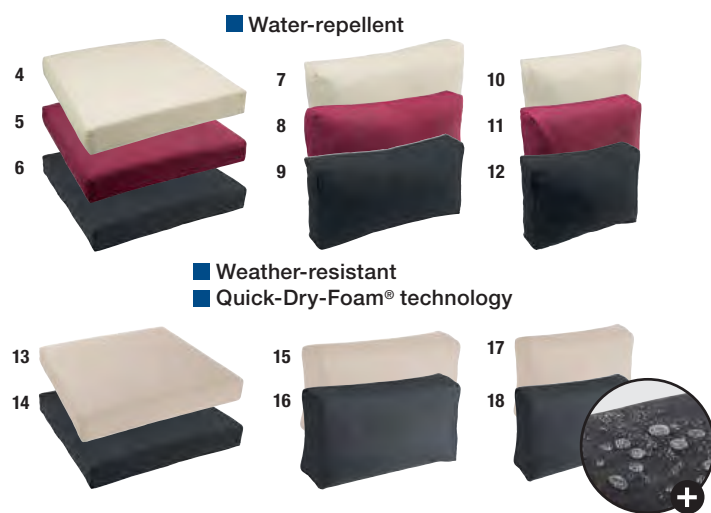

Water-repellent

Weather-resistant
Quick-Dry-Foam® technology

Cushion & all-weather cushion COMBINE

The polyester cover is made of mottled effect material. Seat cushion (fig. 4 - 6, 13, 14) with special non-slip coating on the back.

Cushion cover: 100% polyester. 30 °C washable.

All-weather cushion cover: 100% polypropylene. 30 °C washable.

Special Quick-Dry-Foam® technology! Water-repellent and UV-resistant! Removable!

	Seat cushion	Back cushion	Side cushion
WxDxH cm	70x70x11	70x21x40	49x21x40
off-white	4 10089320	7 10089322	10 10089321
berry	5 10089314	8 10089316	11 10089315
anthracite	6 10089308	9 10089310	12 10089309
Piece €	42,99	32,99	26,99
	All-weather seat cushion	All-weather back cushion	All-weather side cushion
WxDxH cm	70x70x11	70x21x40	49x21x40
natural mottled	13 10089354	15 10089355	17 10089356
black mottled	14 10089359	16 10089360	18 10089361
Piece €	61,99	41,99	31,99

4. Add side elements if required

2 colors available

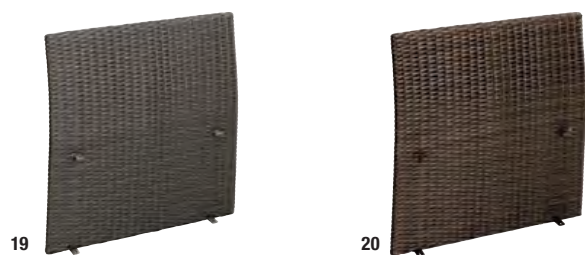

	WxDxH cm	Weight kg	Color	Ref.	Piece €
19	70x9x72	3.5	dark taupe	10089671	94,99
20			tobacco	10089672	94,99



Matching cushion box MALACCA see p. 357 and at

www.em-group.com



Furniture outdoor

Base element
COMBINE

125⁰⁰

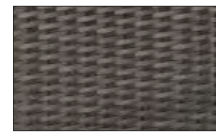

1 dark taupe

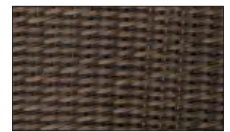

2 tobacco

Combination possibilities:



Complete your selection with a table

1. Choose a base element

2 colors available

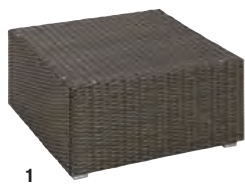

1



2

2. Add a table top

Table top
COMBINE

82⁹⁹



21

	WxDxH cm	Weight kg	Color	Ref.	Piece €
1	70x70x32	5.0	dark taupe	10089668	125,00
2			tobacco	10089669	125,00

	LxWxH cm	Weight kg	Color	Ref.	Piece €	
21	Table top	69.5x69.5x0.5	5.4	grey	10089599	82,99



> Illuminated flower pot see p. 411

1-seater element
LOGGIA
129,00



1



3



5



7



9

■ Individually usable

Bench
LOGGIA
119,00



2



4



6



8



10

Row connector
LOGGIA
4,98



11



Lounge series LOGGIA

Consists of different seating elements and a lounge table. Absolutely weather-resistant and flexible to use! The padded lounge is made of aluminum covered with a UV-resistant plastic fabric. Side table includes screws to compensate for ground irregularities. This lounge can be put together and linked by 2 row connectors (fig. 11). The side table is delivered including a glass table top in stone look, which rests securely due to transparent stoppers.

Material: Aluminum and plastic.

Weatherproof! Easy to clean! Individually usable! UV-resistant!

	WxDxH cm	Seat height cm	Weight kg	Color	Ref.	Pcs./pack	Pack €	Piece €
1	59x77x82	39	5.6	anthracite	10094718	1	–	129,00
2				taupe	10094717	1	–	129,00
3	77x77x82	39	8.2	anthracite	10094720	1	–	169,00
4				taupe	10094719	1	–	169,00
5	70x45x40	–	7.2	anthracite	10094722	1	–	94,99
6				taupe	10094721	1	–	94,99
7	46x46x46	–	2.4	anthracite	10008102	2	139,98	69,99
8				taupe	10008101	2	139,98	69,99
9	110x46x46	–	4.0	anthracite	10008104	1	–	119,00
10				taupe	10008103	1	–	119,00
11	Row connector (2-piece)	6.5x4.0x4.0		black	10099679			Set € 4,98



■ Stool can also be used as a table



Lounge series BARREL

Made of a sturdy aluminum frame and high-quality wickerwork. Perfect for outdoor use as it is weather-resistant and UV-resistant. The stool can be easily used as a side table with the glass table top (fig. 16).

Material: Aluminum frame and high-quality brand wickerwork!
Durable! UV-resistant! Suitable for outdoors!

		Dimension cm	Seat height cm	Weight kg	Color	Ref.	Pcs./pack	Pack €	Piece €
12	Armchair	LxWxH 68x62x79	43	6.2	dark taupe	10095052	2	238,00	119,00
13					tobacco	10095053	2	238,00	119,00
14	Stool/ Side table	ØxH 55x43	43	4.0	dark taupe	10095056	1	–	79,99
15					tobacco	10095057	1	–	79,99

Glass table top
 BARREL
29.99



Cushion
 BARREL
12.99

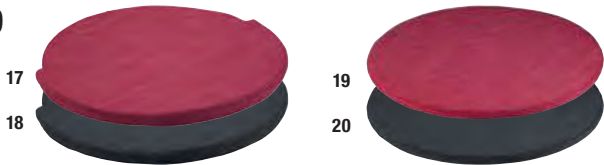

Cushion BARREL

The fabric cover made of mottled effect material can be easily removed from the foam filling. Perfect grip - even without straps - guarantees the non-slip underside.

Cover: 100% polyester. 30 °C washable.
Filling: Polyurethane. Water-repellent! UV-resistant!

Glass table top BARREL

Matching glass table top in stone look for stool/side table. With 10 non-slip stoppers for a secure hold.

Material: Safety glass.

	ØxH cm	Weight kg	Ref.	Piece €
16	55.0x0.5	3	10095058	29,99

	Suitable for	Dimension cm	Color	Ref.	Pcs./pack	Pack €	Piece €
17	Armchair	LxWxH 54x52x4	berry	10089345	2	25,98	12,99
18			anthracite	10089343	2	25,98	12,99
19	Stool	ØxH 55x4	berry	10089346	1	–	12,99
20			anthracite	10089344	1	–	12,99



Armchair
METROPOLITAN
129⁰⁰

1

10



1

2

3

4

5



Armchair METROPOLITAN

This furniture is made of high-quality brand wickerwork and very durable and UV-resistant. The frame is made of sturdy aluminum, aluminum caps on the feet protect the wickerwork.

UV-resistant! Weatherproof! 3-year availability guarantee!

	LxWxH cm	Seat height cm	Weight kg	Color	Ref.	Pcs./ pack	Pack €	Piece €
1	57.5x62.0x86.0	46	5.6	vintage white	10094903	2	258,00	129,00
2				grey	10094707	2	258,00	129,00
3				dark taupe	10094042	2	258,00	129,00
4				black	10094908	2	258,00	129,00
5				tobacco	10094909	2	258,00	129,00

Seat cushion
VINCENT
8⁴⁹



- Water-repellent
- UV-resistant



Seat cushion VINCENT

The cover can be easily removed by a zipper from the foam filling. The cover is water-repellent and UV-resistant. Perfect hold - even without straps guaranteed by the slip-resistant bottom made of PVC.

Cover: 100% polyester. 30 °C washable.

Filling: Polyester. Water-repellent and UV-resistant! Removable!

	WxDxH cm	Color	Ref.	Piece €
6	40x40x3	ecru	10082778	8,49
7		light brown	10082777	8,49
8		chocolate	10082780	8,49
9		berry	10082776	8,49
10		apple green	10082773	8,49
11		bordeaux	10082775	8,49
12		anthracite	10082774	8,49
13		petrol	10080335	8,49

Seat cushion
METROPOLITAN
9⁹⁹



- Water-repellent
- UV-resistant



Seat cushion METROPOLITAN

The cover can be easily removed from the foam filling by a zipper.

Cover: 100% polyester. 30 °C washable.

Filling: Polyether foam.

Water-repellent! UV-resistant!

	WxDxH cm	Color	Ref.	Pcs./ pack	Pack €	Piece €
14	42.0x43.0 x3.5	ecru	10089294	2	19,98	9,99
15		light brown	10089293	2	19,98	9,99
16		chocolate	10089296	2	19,98	9,99
17		berry	10089292	2	19,98	9,99
18		apple green	10089289	2	19,98	9,99
19		bordeaux	10089291	2	19,98	9,99
20		anthracite	10089290	2	19,98	9,99
21		petrol	10080348	2	19,98	9,99

All-weather seat cushion
METROPOLITAN

13⁹⁹

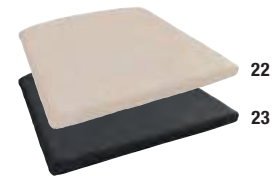

- Quick-Dry-Foam®
technology

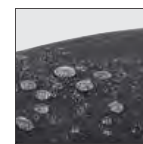

Water-repellent



All-weather seat cushion METROPOLITAN

The easy care, removable cover is lightfast, UV-resistant, highly water-repellent and very durable. And the foam padding inside dries extremely fast thanks to the special Quick-Dry-Foam® technology.

Cover: 100% polypropylene. 30 °C washable.

	WxDxH cm	Color	Ref.	Pcs./ pack	Pack €	Piece €
22	43.0x42.0 x3.5	natural mottled	10089358	2	27,98	13,99
23		black mottled	10089363	2	27,98	13,99



- Lightweight
- Stackable



Chair
METROPOLITAN, from
69⁹⁹

33

> Table METROPOLITAN see p. 364

Furniture outdoor



Chair METROPOLITAN

This series is made of high-quality brand wickerwork and is very durable and UV-resistant. The frame is made of sturdy aluminum, aluminum caps on the feet protect the wickerwork.

Material frame: Aluminum, wickerwork made of high-density polyethylene. UV-resistant! Weatherproof! Stackable! 3-year availability guarantee!

	WxDxH cm	Seat height cm	Weight kg	Color	Ref.	Pcs./pack	Pack €	Piece €	
24	48.0x56.0x90.5	46	4	vintage white	30002380	2	139,98	69,99	
25				grey	30002377	2	139,98	69,99	
26				Chair without armrest	dark taupe	30002387	2	139,98	69,99
27				black	30002378	2	139,98	69,99	
28				tobacco	30002379	2	139,98	69,99	
29	55.0x63.0x93.5	46	4.5	vintage white	10094595	2	179,98	89,99	
30				grey	10095040	2	179,98	89,99	
31				Chair with armrest	dark taupe	10094036	2	179,98	89,99
32				black	10094662	2	179,98	89,99	
33				tobacco	10095039	2	179,98	89,99	



Wickerwork chair
VINCENT
79⁹⁹

34

> Table base KROMO see p. 346

- Lightweight
- Stackable



34



Wickerwork chair VINCENT

The wickerwork chair VINCENT made of brushed aluminum in stainless steel look convinces with its high quality workmanship and comfort. The armrests are equipped with teak. Up to 5 chairs stackable.

Material: High-quality polyethylene wickerwork. Frame: Aluminum, brushed. Stackable! Stable! Weatherproof! 3-year availability guarantee!

	WxDxH cm	Seat height cm	Weight kg	Color	Ref.	Pcs./pack	Pack €	Piece €
34	54.0x52.5x86.0	44	3.5	dark taupe	10094680	2	159,98	79,99

Diverse combinable!



■ Glass or high-pressure laminate table top sold separately

Table METROPOLITAN, from **185⁹⁹**

Table METROPOLITAN

All table frames are made of high-quality brand wickerwork and are very durable and UV-resistant. The frame is made of sturdy aluminum, aluminum caps on the feet protect the wickerwork. The table tops are available either in safety glass in white or black stone look or in high-pressure laminate in grey.

Material: Aluminum frame, wickerwork made of high-density polyethylene. UV-resistant! Weatherproof! Bar table frame incl. foot rest made of aluminum in stainless steel look! 3-year availability guarantee!



Table top

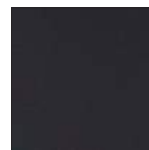

1 - 3
Glass black



4 - 6
High-pressure laminate grey

Table frame

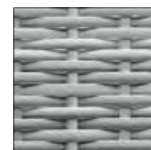

grey



vintage white



dark taupe

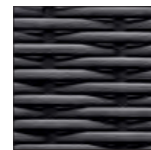

black



tobacco

	LxWxH cm	Weight kg	Color	Ref.	Piece €
1	71.0x79.5x0.5	7.5	black	10094436	66,99
2	121.0x79.5x0.5	12.5	black	10094438	92,99
3	61.0x69.5x0.5	5.5	black	10094442	52,99
4	71.0x79.5x0.5	4.8	grey	10089532	99,99
5	121.0x79.5x0.5	8.0	grey	10089531	139,00
6	61.0x69.5x0.5	3.5	grey	10089533	69,99
7	80.0x80.0x75.0	8.5	grey	10099450	119,00
8			vintage white	10099451	119,00
9			dark taupe	10099452	119,00
10			black	10099453	119,00
11			tobacco	10099454	119,00
12	130.0x80.0x75.0	11.0	grey	10099455	139,00
13			vintage white	10099456	139,00
14			dark taupe	10099457	139,00
15			black	10099458	139,00
16			tobacco	10099459	139,00

	LxWxH cm	Weight kg	Color	Ref.	Piece €
17	70.0x70.0x110.0	11.0	grey	10099445	159,00
18			vintage white	10099446	159,00
19			dark taupe	10099447	159,00
20			black	10099448	159,00
21			tobacco	10099449	159,00

*Easy assembly, delivered disassembled.

Seat cushion
METROPOLITAN
999

- Water-repellent
- UV-resistant



Seat cushion METROPOLITAN

The cover can be easily removed from the foam filling by a zipper.

Cover: 100% polyester. 30 °C washable.

Filling: Polyether foam.

Water-repellent! UV-resistant!

	WxDxH cm	Color	Ref.	Pcs./ pack	Pack €	Piece €
22	42.0x43.0 x3.5	ecru	10089294	2	19,98	9,99
23		light brown	10089293	2	19,98	9,99
24		chocolate	10089296	2	19,98	9,99
25		berry	10089292	2	19,98	9,99
26		apple green	10089289	2	19,98	9,99
27		bordeaux	10089291	2	19,98	9,99
28		anthracite	10089290	2	19,98	9,99
29		petrol	10080348	2	19,98	9,99



Bar chair
METROPOLITAN
9999



30



31



32



33



34

Bar chair METROPOLITAN

Made of high-quality brand wickerwork, they are particularly durable and UV-resistant. The frame is made of sturdy aluminum, aluminum caps on the feet protect the wickerwork.

Material: Aluminum frame, wickerwork made of high-density polyethylene.

Weatherproof! UV-resistant! With stainless steel foot rest!

3-year availability guarantee!



	WxDxH cm	Seat height cm	Weight kg	Color	Ref.	Pcs./ pack	Pack €	Piece €
30	45x51x110	81	5	vintage white	10099094	2	199,98	99,99
31				grey	10099093	2	199,98	99,99
32				dark taupe	10094039	2	199,98	99,99
33				black	10099098	2	199,98	99,99
34				tobacco	10099102	2	199,98	99,99



Lounger pad
MELROSE
64,99



■ Water-repellent



Lounger pad MELROSE

On the underside of the pad there is a special non-slip PVC coating.

Cover: 100% polyester. 30 °C washable.

Filling: Polyurethane foam.

Water-repellent and UV-resistant!

	LxWxH cm	Color	Ref.	Piece €
6		ecru	10082769	64,99
7	196x60x5	anthracite	10082767	64,99
8		berry	10082768	64,99

Lounger
METROPOLITAN
299,00



- Height-adjustable backrest
- High-quality wheels
- Stackable



All-weather lounge pad
METROPOLITAN
99,99

- Water-repellent
- Quick-Dry-Foam® technology



All-weather lounge pad METROPOLITAN

The easy care, removable cover is lightfast, UV-resistant, highly water-repellent and very durable. The foam padding inside dries extremely fast thanks to the special Quick-Dry-Foam® technology. Ideal for outdoors!

Cover: 100% polypropylene. 30 °C washable!

	LxWxH cm	Color	Ref.	Piece €
9	196x60x5	natural mottled	10089357	99,99
10		black mottled	10089362	99,99

Lounger METROPOLITAN

The loungers are made of high-quality brand wickerwork and are very durable and UV-resistant. The frame is made of sturdy aluminum, aluminum caps on the feet protect the wickerwork. All loungers are stackable and equipped with 2 high-quality wheels. The backrest is adjustable in 4 different positions as well as flat adjustable. Ideal for outdoors.

Material frame: Aluminum, wickerwork made of high-density polyethylene.

UV-resistant! Durable! Weatherproof! Stackable! With wheels! Aluminum caps on the feet! 3-year availability guarantee!

	LxWxH cm	LxW cm (Lying area)	Weight kg	Color	Ref.	Piece €
1	202.0x83.5x34.0	196x65	15	vintage white	10094108	299,00
2				grey	10094350	299,00
3				dark taupe	10094109	299,00
4				black	10094351	299,00
5				tobacco	10094110	299,00



Please contact our customer service for a sample set!

+49 8272 807 447



Chair
MELROSE, from
64⁹⁹

> Table base ARGENTO see p. 343



- Stackable
- Easy to clean

Lounger
MELROSE
179⁰⁰



Lounge table
MELROSE
29⁹⁹



Furniture series MELROSE

The modern lounge series in wickerwork look is made of sturdy, fiberglass reinforced plastic. MELROSE convinces not only by the modern design, but also by the durability, UV-resistance and easy care. Chair, bench and bar chair are stackable up to 4 pieces. The loungers are equipped with hidden wheels on the feet and plastic gliders. The backrest is adjustable in 4 different positions. Loungers are stackable up to 10 pieces. Ideal for outdoors.

Material: Fiberglass reinforced plastic. UV-resistant! Durable! Weatherproof! Stackable!

	Dimension cm	Seat height cm	Weight kg	Color	Ref.	Pcs./pack	Pack €	Piece €
11 Chair with armrest	WxDxH 57.0x59.0x88.0	46.5	4.9	brown	10093866	2	159,98	79,99
12 Chair without armrest	WxDxH 45.0x46.0x88.0	46.5	3.8	anthracite	10093865	2	159,98	79,99
13 Chair with armrest	WxDxH 57.0x59.0x88.0	46.5	4.9	brown	10094224	2	129,98	64,99
14 Chair without armrest	WxDxH 45.0x46.0x88.0	46.5	3.8	anthracite	10094223	2	129,98	64,99
15 Bar chair	WxDxH 45.0x51.0x108.0	75.0	5.0	brown	10094494	4	271,96	67,99
16 Bar chair	WxDxH 45.0x51.0x108.0	75.0	5.0	anthracite	10094493	4	271,96	67,99
17 Lounger	LxWxH 189.0x79.0x43.5	35.0	11.5	brown	10093863	1	-	179,00
18 Lounger	LxWxH 189.0x79.0x43.5	35.0	11.5	anthracite	10093862	1	-	179,00
19 Lounge table*	WxDxH 45.0x45.0x45.0	-	2.5	brown	10093878	1	-	29,99
20 Lounge table*	WxDxH 45.0x45.0x45.0	-	2.5	anthracite	10093877	1	-	29,99

*Tables delivered disassembled, easy assembly. Please fix the legs with a rubber mallet.



- Lightweight and robust
- Stackable
- UV-resistant

Chair
MIRA
42⁹⁹



1



2



3

- Lightweight and robust
- Stackable
- UV-resistant



4



5



Chair MIRA

Modern, comfortable, practical and colorful: The chair series MIRA is made of weatherproof plastic and anodised aluminum. The sturdy chair is stackable up to 8 pieces.

Material: Polypropylene, aluminum. Stackable! Weatherproof! Easy to clean!

	WxDxD cm	Seat height cm	Weight kg	Color	Ref.	Pcs./ pack	Pack €	Piece €
1	44.5x51.5x85.0	44.5	3.3	grey	10008187	6	257,94	42,99
2				anthracite	10008186	6	257,94	42,99

Chair RABEA

Elegant, simple, fiberglass reinforced plastic chair in modern colors. The sturdy chair is stackable up to 8 pieces. Suitable for indoors and outdoors.

Material: Fiberglass reinforced polypropylene.

Stackable! Weatherproof! UV-resistant!

	WxDxD cm	Seat height cm	Weight kg	Color	Ref.	Pcs./ pack	Pack €	Piece €
3	45.0x52.0x80.5	45.5	3.1	orange	10093884	4	159,96	39,99
4				light grey	10093886	4	159,96	39,99
5				anthracite	10093885	4	159,96	39,99



Chair with armrest
NIARA

79⁹⁹

*Makes a good mood
in any weather*

- Lightweight and hard-wearing
- Stackable
- UV-resistant

Chair without armrest
NIARA

69⁹⁹



Chair NIARA

The stackable and weatherproof outdoor chair NIARA is a very attractive and interesting eye-catcher: Its modern shape promises high seating comfort. Made of UV-resistant, high-quality polypropylene with fiberglass reinforcement and non-slip chair legs, makes this chair a first-class choice. Stackable up to 5 pieces. Matching seat cushion: Fig. 14 + 15.

Material: Polypropylene with fiberglass reinforcement.
Stackable! UV-resistant! Fully dyed!

	WxDxH cm	Seat height cm	Weight kg	Color	Ref.	Pcs./ pack	Pack €	Piece €
6	52.0x55.0x84.0	46.5	3.5	taupe	30001697	4	279,96	69,99
7				mustard	30001696	4	279,96	69,99
8				marsala	30001695	4	279,96	69,99
9				anthracite	30001694	4	279,96	69,99
10	60.5x58.5x80.0	46.5	4.0	taupe	10070513	4	319,96	79,99
11				mustard	10070516	4	319,96	79,99
12				marsala	10070511	4	319,96	79,99
13				anthracite	10070512	4	319,96	79,99

All-weather seat cushion
METROPOLITAN

13⁹⁹

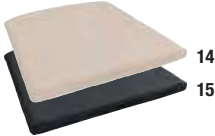

All-weather seat cushion METROPOLITAN

The easy care, removable cover is lightfast, UV-resistant, highly water-repellent and very durable. And the foam padding inside dries extremely fast thanks to the special Quick-Dry-Foam® technology.

Cover: 100% polypropylene. 30 °C washable.

	WxDxH cm	Color	Ref.	Pcs./pack	Pack €	Piece €
14	43.0x42.0x2.5	natural mottled	10089358	2	27,98	13,99
15		black mottled	10089363	2	27,98	13,99



- Ferrari Batyline®
- Durable and lightweight
- Foldable
- 2 frame colors



Folding chair BELIZE

High-quality folding chair with sturdy aluminum frame. Backrest and seat made of high-quality Ferrari Batyline®. This material is especially easy care, weather and UV-resistant and fast-drying, making it ideal for indoors and outdoors. The folding chair also fits perfectly to the deck chair BELIZE and the chair series TAILOR.

Dimension folded: 47x17x99 cm.

Material: Aluminum, powder-coated.

Fabric: Ferrari Batyline®.

Foldable! Weatherproof!

	WxDxH cm	Seat height cm	Weight kg	Color (seat/frame)	Ref.	Pcs./ pack	Pack €	Piece €
1				anthracite/silver	10099364	2	139,98	69,99
2	47.0x55.0x85.5	45	3.5	petrol/anthracite	10099365	2	139,98	69,99
3				taupe/anthracite	10099367	2	139,98	69,99

Folding chair
BELIZE

69⁹⁹

> Table top LIFT und table base ADRIANO see p. 342, 347



- Ferrari Batyline®
- Durable and lightweight
- Foldable
- 2 frame colors



Deck chair BELIZE

The deck chair BELIZE with cushion is adjustable in four positions and easy to fold and looks very inviting in every outdoor area. Its frame is made of sturdy, powder-coated aluminum. The fabric is high-quality Ferrari Batyline® – easy care and UV-resistant. Suitable for indoors and outdoors. The deck chair also fits perfectly to the folding chair series TAILOR.

Dimension folded: 62x12x128 cm.

Material: Aluminum, powder coated. Fabric: Ferrari Batyline®.

Foldable! Weatherproof! With cushion!



Deck chair
BELIZE
105⁰⁰

	WxDxH cm	Weight kg	Color (seat/frame)	Ref.	Pcs./ pack	Pack €	Piece €
4			anthracite/silver	10097711	2	210,00	105,00
5	58x111x90	7	petrol/anthracite	10097712	2	210,00	105,00
6			taupe/anthracite	10097715	2	210,00	105,00



Lounger
TAILOR
219⁰⁰

10

Furniture outdoor

The modern relaxation guarantee

- Ferrari Batyline®
- Durable and lightweight
- Stackable
- 2 frame colors

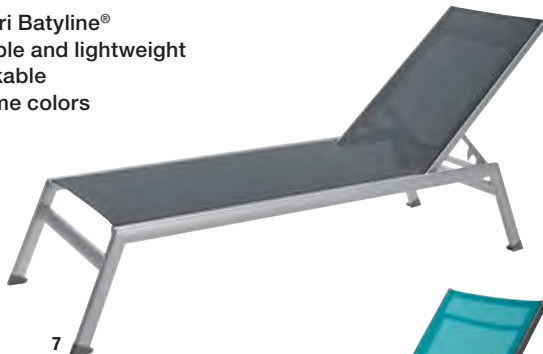

7



8



9



10



Lounger TAILOR

High-quality loungers made of powder-coated aluminum. The durable and UV-resistant fabric is high-quality Ferrari Batyline®, it is easy care, weather and UV-resistant and quick-drying. With innovative gliders, up to 5 loungers can easily be stacked without scratching. The backrest is adjustable in 4 different positions. Lying surface 193x52 cm.

Material: Aluminum, powder-coated. Fabric: Ferrari Batyline®. Stackable! UV-resistant! Weatherproof! 3-year availability guarantee!

	LxWxH cm	Seat height cm	Weight kg	Color (seat/frame)	Ref.	Piece €
7	208x59x34	34	9	anthracite/silver	10095301	219,00
8				white/anthracite	10099132	219,00
9				petrol/anthracite	10097701	219,00
10				taupe/anthracite	10097702	219,00



+49 8272 807 447



service@em-group.com



www.em-group.com

371



Chair
TAILOR, from
74⁹⁹



- Ferrari Batyline®
- Durable and lightweight
- Stackable
- 2 frame colors



Chair TAILOR

TAILOR is not only visually appealing, it convinces above all by its quality. The UV-resistant frame is made of sturdy aluminum and is powder-coated. Durable and UV-resistant fabric. All chairs have a stacking protection at the bottom, which protects against scratches. Teak armrests at chairs with armrest.

Material: Ferrari Batyline®. Frame: Powder-coated aluminum.

Stackable! Stabil! Weatherproof! Stacking protection! 3-year availability guarantee!

	WxDxH cm	Seat height cm	Weight kg	Color frame	Color seat	Ref.	Pcs./ pack	Pack €	Piece €
1	56x58x84	44.5	4	silver	anthracite	10092532	2	179,98	89,99
2				petrol	10097699	2	179,98	89,99	
3				anthracite	white	10099131	2	179,98	89,99
4				taube	10097700	2	179,98	89,99	
5	48x57x84	44.5	3	silver	anthracite	10092461	2	149,98	74,99
6				petrol	10097697	2	149,98	74,99	
7				anthracite	white	10099130	2	149,98	74,99
8				taube	10097698	2	149,98	74,99	

Bar chair
TAILOR
119⁰⁰

- Ferrari Batyline®
- Durable and lightweight
- 2 frame colors



Bar chair TAILOR

This bar chair convinces above all by its quality. The frame is made of sturdy aluminum and is powder-coated. Durable and UV-resistant fabric.

Material: Ferrari Batyline®. Frame: Powder-coated aluminum.

Stable! Weatherproof! 3-year availability guarantee!

	WxDxH cm	Seat height cm	Weight kg	Color frame	Color seat	Ref.	Pcs./ pack	Pack €	Piece €
9	47x55x117	77	5	silver	anthracite	10097717	2	238,00	119,00
10				petrol	10097718	2	238,00	119,00	
11				anthracite	white	10097716	2	238,00	119,00
12				taube	10097720	2	238,00	119,00	



Chair
COSIMO
84⁹⁹

14

14

> Table top LIFT table base ADRIANO see p. 342, 347

Sit your guests comfortably outside



Your benefit

Immediately usable after rain thanks to **fast drying, integrated padding**

Stackable: Space-saving storage

Easy to clean thanks to **easy care Textilene® material**



13



14

Chair COSIMO

With a straightforward shape, the weatherproof, padded outdoor chair COSIMO fits into any modern terrace. The special benefit of this chair is the very comfortable padding made of durable and easy care textile material and Quick-Dry-Foam®. Stackable up to five chairs.

Material frame: Aluminum in stainless steel look or anthracite powder-coated. Cover: Textilene®.

Weatherproof! Stackable! Very comfortable! Quick-Dry-Foam®! Easy to clean!



	WxDxH cm	Seat height cm	Weight kg	Color frame	Color seat	Ref.	Pcs./ pack	Pack €	Piece €
13	55x56x87	45	3.5	stainless steel look	anthracite	10080518	2	169,98	84,99
14				powder- coated	anthracite	10080547	2	169,98	84,99



+49 8272 807 447



service@em-group.com



www.em-group.com

373



Furniture series FILEA

The innovative furniture series FILEA enriches every outdoor area. Whether as a chair with or without armrest, as a bar chair, lounge or stool - the weatherproof and stackable seating elements in the colors anthracite or beige not only impress with their modern design. You can also rely on very sturdy, powder-coated steel frames with plastic gliders to make sitting comfortably thanks to a very dense rope wickerwork made of durable polypropylene and polyester.

Material: Powder-coated, galvanized steel, 98% polypropylene and 2% polyester yarn. Quick drying rope wickerwork! Durable!



	WxDxH cm	Seat height cm	Weight kg	Color	Ref.	Pcs./ pack	Pack €	Piece €
1 Chair with 2 armrest	58.0x56.0x87.0	47	4.5	anthracite	30002036	4	359,96	89,99
				beige	30002037	4	359,96	89,99
3 Chair with- 4 out armrest	58.0x56.0x87.0	47	3.9	anthracite	30002031	4	319,96	79,99
				beige	30002013	4	319,96	79,99
5 Bar chair 6	62.0x60.0x108.0	72	4.9	anthracite	30002004	2	218,00	109,00
				beige	30001999	2	218,00	109,00
7 Lounge 8	73.5x67.0x75.0	42	5.0	anthracite	30001996	2	210,00	105,00
				beige	30001994	2	210,00	105,00
9 Stool 10	68.0x59.0x40.0	-	3.0	anthracite	30002015	2	139,98	69,99
				beige	30001995	2	139,98	69,99



Chair with armrest
FILEA
89⁹⁹

> Teak table top LUIGI see p. 342



Galvanized steel frame



Comfortable thanks to a dense rope wickerwork



Chair gliders with anti-scratch function

- Comfortable
- Stackable
- UV-resistant

Bar chair
FILEA
109⁰⁰



Stool
FILEA
69⁹⁹





- Lightweight and robust
- Stackable
- UV-resistant



Chair LAIN

Outdoor and design - if you have the highest demands on both properties, our chair LAIN is a real highlight. With its filigree frame made of stainless steel, the down-drawn seat and the striking backrest, it is an attractive further development of the classic outdoor chair - and an eye-catcher in the modern lounge and terrace ambience. Its durable UV and weather-resistant plastic wickerwork looks modern in three attractive colors. Up to four chairs are stackable, so LAIN meets all the design and function requirements. An excellent choice!

Material: Plastic wickerwork. Frame: Stainless steel.
Suitable for outdoors! UV-resistant! Stackable!

	WxDxH cm	Seat height cm	Weight kg	Color	Ref.	Pcs./ pack	Pack €	Piece €
1	57x62x77	45	4.6	anthracite	10095049	2	210,00	105,00
2				taupe	10095051	2	210,00	105,00
3				off-white	10095050	2	210,00	105,00

- Water-repellent
- UV-resistant

Seat cushion
CHAPTER

9⁹⁹



Seat cushion CHAPTER

This water-repellent and lightfast seat cushion is suitable for the chair CHAPTER and also ideal for outdoors. The durable cover has a special non-slip coating on the underside of the cushion which ensures that the cushion always remains in place.

Cover: 100% polyester. Filling: Polyether foam. Water-repellent! Lightfast!

	WxDxH cm	Color	Ref.	Pcs./ pack	Pack €	Piece €
4		anthracite	10070669	4	39,96	9,99
5	36.5x41.0x2.5	ecru	10070673	4	39,96	9,99
6		petrol	10080349	4	39,96	9,99



Furniture outdoor

Clean design in timeless colors

Chair
CHAPTER
64⁹⁹



- Stackable
- Weatherproof



Chair CHAPTER

Would you like to have a chair for your outdoor area that is modern and straightforward and at the same time meets the highest functional requirements? The weatherproof outdoor chair CHAPTER, which is ideally suited for any modern ambience, is made of very sturdy, powder-coated aluminum with a thickness of 1,2 mm. Available in classic-timeless and trendy colors. It also features comfortable armrests with stacking protection. Stackable up to 5 chairs.

Material: Aluminum, powder-coated. Weatherproof! Stackable! Stacking protection!

	WxDxH cm	Seat height cm	Weight kg	Color	Ref.	Pcs./ pack	Pack €	Piece €
7				anthracite	10080717	4	259,96	64,99
8				taupe	10080718	4	259,96	64,99
9	55x57x86	43	3.8	olive	10070568	4	259,96	64,99
10				marsala	10070570	4	259,96	64,99
11				blue	10070569	4	259,96	64,99



Table round
SUNNY
135⁰⁰

- Foldable
- Large selection of colors
- Weatherproof



Furniture series SUNNY

Ingeniously simple: These round or angular folding tables and matching folding chairs are true classics among outdoor furniture. What distinguishes them is their first-class galvanized steel, their durability and weather resistance. Ideal for outdoors. Matching seat cushions see 17 - 19.

Material: Steel, powder-coated and galvanized. Table top thickness: 3,5 cm. Weatherproof! Foldable! Feet with plastic caps!

	Dimension cm	Seat height cm	Weight kg	Color	Ref.	Pcs./pack	Pack €	Piece €
1	WxDxH 42.5x43.0x81.0	44	4.8	anthracite	10094356	2	109,98	54,99
2				red	10089148	2	109,98	54,99
3				green	10094358	2	109,98	54,99
4				blue	10094357	2	109,98	54,99

	Dimension cm	Weight kg	Color	Ref.	Piece €
5	Table round* ØxH 80.0x74.0	10.1	anthracite	10094364	135,00
6			red	10070125	135,00
7			green	10094366	135,00
8			blue	10094365	135,00
9	Table rectangular* LxWxH 70.0x50.0x74.0	8.1	anthracite	10094360	125,00
10			red	10089149	125,00
11			green	10094362	125,00
12			blue	10094361	125,00
13	LxWxH 110.0x70.0x74.0	16.4	anthracite	10008420	199,00
14			red	10008423	199,00
15			green	10008421	199,00
16			blue	10008422	199,00

*Easy assembly, delivered disassembled.



Chair
SUNNY
54⁹⁹

- With magnet
- Waterproof
- UV-resistant

Seat cushion
SUNNY
19⁹⁹

Seat cushion SUNNY

Complement the chairs SUNNY with our seat cushion and offer your guests optimum seating comfort. The cushions are made of a waterproof and extremely weather and UV-resistant fabric. Inside is a strong magnet, so they stay firmly on the seat and do not slip. Easy to clean with a soft cloth and mild detergent.

Material: 70% polychloride, 30% polyester. Filling: Polyester. Waterproof! Weather and UV-resistant! Magnet inside!



	WxDxH cm	Color	Ref.	Pcs./pack	Pack €	Piece €
17		green	10094431	2	39,98	19,99
18	40.0x28.0x1.5	blue	10094433	2	39,98	19,99
19		anthracite	10094435	2	39,98	19,99



Table
ATELIO, from
179⁰⁰

Breezy vintage ambience



Furniture series ATELIO

This furniture series impresses with its vintage look and at the same time fulfills all the modern requirements. The chairs and tables have a stylish design and are available in three trendy colors, which are also nice to combine. Due to a special surface the tables are particularly easy to clean. The furniture series is made of high-quality powder-coated aluminum and thus is very robust and insensitive to bad weather conditions. Even indoors they harmoniously fit into any vintage or shabby chic ambience. Including ground-friendly plastic gliders.

Material: Powder-coated aluminum! Easy to clean! Chair stackable!

	Dimension cm	Seat height cm	Weight kg	Color	Ref.	Pcs./pack	Pack €	Piece €
1	WxDxH 55x51x89	45	5.8	vintage grey	30003526	2	179,98	89,99
2				vintage white	30003527	2	179,98	89,99
3				vintage blue	30003525	2	179,98	89,99



- Chair stackable
- UV-resistant
- Easy to clean

	Dimension cm	Weight kg	Color	Ref.	Piece €
4	ØxH 80x75	8.7	vintage grey	30026674	179,00
5			vintage white	30026673	179,00
6			vintage blue	30026672	179,00
7	LxWxH 75x75x76	8.7	vintage grey	30003532	179,00
8			vintage white	30003533	179,00
9			vintage blue	30003531	179,00
10	LxWxH 120x75x76	11.5	vintage grey	30003529	229,00
11			vintage white	30003530	229,00
12			vintage blue	30003528	229,00

NEW

Furniture outdoor



> Clipboard COLORADO see p. 437

Chair
ATELIO
89⁹⁹



The clever bistro seating



Furniture series MALVENA

The weatherproof chairs and tables are made of high-quality aluminum and finished with a powder-coating in different colors. For optimum space-saving up to 6 chairs can be stacked on top of each other. The chair frames with a diameter of 2.5 cm and a material thickness of 2 mm are easy to clean, scratch-resistant and suitable for outdoors!

Material: Aluminum, powder-coated. Weatherproof! Chair stackable! Easy to clean! 3-year availability guarantee!

	Dimension cm	Seat height cm	Weight cm	Color	Ref.	Pcs./ pack	Pack €	Piece €
1	WxDxH 52x59x72	43.5	3.0	anthracite	10008116	4	159,96	39,99
2				silver	10008464	4	159,96	39,99
3				taupe	10008500	4	159,96	39,99
4				olive	10008465	4	159,96	39,99
5	LxWxH 70x70x72	-	7.4	anthracite	10008118	1	-	79,99
6				silver	10008468	1	-	79,99
7				taupe	10008502	1	-	79,99
8				olive	10008469	1	-	79,99
9	ØxH 60x72	-	6.2	anthracite	10008117	1	-	69,99
10				silver	10008466	1	-	69,99
11				taupe	10008501	1	-	69,99
12				olive	10008467	1	-	69,99

- Lightweight
- Chair stackable
- Weatherproof

Chair MALVENA
39⁹⁹



1



2



3



4



5



6

Table square MALVENA
79⁹⁹



7



8



9



10

Table round MALVENA
69⁹⁹



11



12



1

5

13

Chair
DANILO

44⁹⁹

> Glass series SINY see p. 117



Seat cushion FIRENZE and LINEARES can be found at

www.em-group.com

- Lightweight
- Chair stackable
- Weatherproof



13



14



Chair DANILO

This chair with comfortable armrests is almost a classic. Its frame is made of powder-coated aluminum in various colors, with a diameter of 2.5 cm and a thickness of 2 mm. The high-quality plastic wickerwork tone-on-tone has an incorporated wire core, which increases the durability and stability of the chair. The chairs are easy to clean and stackable up to 6 pieces.

Material: Aluminum, powder-coated. Plastic wickerwork.
Weatherproof! Stackable! Easy to clean! Suitable for outdoors!

	WxDxH cm	Seat height cm	Weight kg	Color	Ref.	Pcs./ pack	Pack €	Piece €
13	52.0x59.5x71.0	43.5	3.5	anthracite	10008119	4	179,96	44,99
14				silver	10008470	4	179,96	44,99
15				olive	10008471	4	179,96	44,99
16				taupe	10008499	4	179,96	44,99



15



16



Bistro chair
AMIGO

29⁹⁹

> Table base ADRIANO see p. 347

- Lightweight
- Easy to clean



Bistro chair AMIGO

AMIGO offers comfortable seating, attractive look and stability at a very attractive price! The frame with a thickness of 1,2 mm made of galvanized, powder-coated steel pipe makes it stable and lightweight. Seat and backrest are made of plastic wickerwork. Matching seat cushion FIRENZE can be found at our online shop.

Material frame: Powder-coated steel with plastic wickerwork.
Weatherproof! UV-resistant! Stackable!

	WxDxH cm	Seat height cm	Weight kg	Color	Ref.	Pcs./ pack	Pack €	Piece €
1	53.0x55.5x75.0	43.5	5	beige	10091852	4	119,96	29,99
2				red	10091858	4	119,96	29,99
3				grey	10091855	4	119,96	29,99



Aluminum wickerwork chair
COLUMBIA

39⁹⁹

> Seat cushion LINEARES see p. 393

- Frame made of aluminum
- Chair stackable



Aluminum wickerwork chair and bar chair COLUMBIA 4 - 6

The high-quality plastic wickerwork chair gets its special stability through an incorporated wire core. The frame is made of aluminum with Ø 2,5 cm and a material thickness of 2 mm. That guarantees durability! Matching seat cushion LINEARES can be found at our online shop.

Material frame: Aluminum with plastic wickerwork.
Absolutely easy to clean! Stackable (fig. 4 - 6)! Weatherproof!

	WxDxH cm	Seat height cm	Weight kg	Color	Ref.	Pcs./ pack	Pack €	Piece €
4	52.0x59.5x71.0	43	3.5	honey	10091426	4	159,96	39,99
5				red	10092324	4	159,96	39,99
6				grey	10092323	4	159,96	39,99
7	50.5x52.0x107.5	78.5	3.6	honey	10091393	2	109,98	54,99
8				red	10092327	2	109,98	54,99
9				grey	10092326	2	109,98	54,99

*Easy assembly, delivered disassembled.



Aluminum chair with armrest
LIMONA
35⁹⁹

Furniture outdoor

Flexible design with cool aluminum



10



11



12

- Lightweight and robust
- Chair stackable



13



14



15

Bar table
LIMONA
62⁹⁹



10 - 11

Aluminum furniture LIMONA

Cool, comfortable and at a reasonable price: Polished aluminum chairs and tables! The lightweight and durable material fits every furnishing and can be used indoors and outdoors. Frame with Ø 2,5 cm and a material thickness of 2 mm. Matching seat cushion LINEARES can be found at our on-line shop.

Material: Anodised aluminum.

Weatherproof! Chair stackable! Table stackable (fig. 14)!

	Dimension cm	Seat height cm	Weight kg	Ref.	Pcs./pack	Pack €	Piece €
10 Aluminum chair without armrest (stackable)	WxDxH 50.0x55.0x78.5	44.0	3.2	10091429	4	127,96	31,99
11 Aluminum chair with armrest (stackable)	WxDxH 53.0x57.0x73.5	43.5	2.9	10092672	4	143,96	35,99
12 Aluminum table square*	LxWxH 70.0x70.0x70.0	-	10.7	10091207	-	-	72,99
13 Aluminum table round*	ØxH 60.0x70.0	-	6.9	10091208	-	-	52,99
Aluminum table square*	LxWxH 60.0x60.0x70.0	-	8.5	10091209	-	-	59,99
14 (stackable)	LxWxH 80.0x80.0x70.0	-	12.1	10091210	-	-	79,99
15 Bar table*	ØxH 60.0x110.0	-	7.6	10091398	-	-	62,99

*Easy assembly, delivered disassembled.



+49 8272 807 447



service@em-group.com



www.em-group.com

385



Table
ALICANTE
149⁰⁰

Bench pad
ALICANTE
28⁹⁹



Bench pad ALICANTE

Suitable for our teak bench ALICANTE. Thanks to a zipper, the pad cover can easily be removed from the 5 cm high foam filling.

Cover: 100% polyester. Filling: Polyether foam. 30 °C washable.

	LxWxH cm	Color	Ref.	Piece €
1	138x50x5	ecru	10089238	28,99
2		berry	10089237	28,99

Care kit Teak

41⁹⁹



Care kit Teak

If you want to keep the original color of your teak furniture permanently, you should treat it with our teak care kit once a year. Set consisting of: 1 l teak cleaner, 1 l protector and 1 brush, 1 sponge and gloves. Sufficient for about 12 chairs.

	Ref.	Set €
3	10090379	41,99

Chair
ALICANTE
54⁹⁹



- Teak solid wood
- Chair and table foldable



Teakwood series ALICANTE

In high-quality we are happy to offer chair, bench and the matching table made of plantation teakwood. Teak is considered to be particularly weatherproof, but after a certain time it can form a silvery shiny patina. This is quite natural and does not represent a defect. If you want to keep the original color of your teak furniture permanently, you should treat it once a year with our teak care kit (see fig. 3). The bench is delivered disassembled.

Weatherproof! Chair and table foldable!



	WxDxH cm	Seat height cm	Weight kg	Ref.	Pcs./pack	Pack €	Piece €
4 Chair (foldable)	47.0x60.0x87.5	44.5	5.2	10093823	2	109,98	54,99
5 Bench	LxWxH 148.0x66.0x93.0	45.0	23.9	10094107	1	–	239,00
6 Table angular	LxWxH 80.0x80.0x75.0	–	20.0	10094106	1	–	149,00

Easy assembly, delivered disassembled.



Find more products at

www.em-group.com

- Teak solid wood
- Lightweight and robust
- Chair stackable



Teakwood series LUIGI

Lightweight and very robust furniture made of solid teakwood and aluminum. The chairs are stackable up to 6 pieces. Please order our care kit fig. 3.

Lightweight! Weatherproof! Easy to clean! Aluminum pipe Ø 2,5 cm (at the chair)! Chair stackable!

	Dimension cm	Seat height cm	Weight kg	Ref.	Pcs./ pack	Pack €	Piece €
7 Chair	WxDxH 50.5x53.0x78.5	44.5	3.6	10091110	4	211,96	52,99
8 Bar chair	WxDxH 42.0x43.5x98.5	81.0	3.6	10091084	2	125,98	62,99
9 Bar table	ØxH 60.0x112.0	-	10.9	10090587	1	-	79,99

Easy assembly, delivered disassembled.

Teak table top
LUIGI, from
69⁹⁹

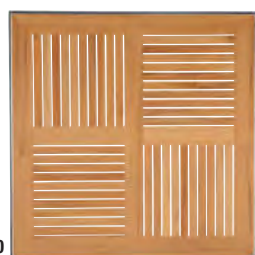

Teak table top LUIGI

The weatherproof table tops made of solid teakwood are available with or without aluminum frame. They fit perfectly with our table bases. Mounting material is included in the table base.

Weatherproof! Easy to clean!

	LxWxH cm	Weight kg	Ref.	Piece €
10 With aluminum frame	60x60x2	3.3	10095063	74,99
	70x70x2	4.2	10095060	79,99
	80x80x2	6.0	10095070	89,99
11 Without aluminum frame	60x60x2	4.0	10095061	69,99
	70x70x2	4.7	10095059	74,99
	80x80x2	6.3	10095062	84,99

The table top is simply screwed to the table base.



Furniture outdoor



Table base
TAIPA
74⁹⁹

- Foldable
- Space-saving storage

Table base
ANEGO
74⁹⁹

- Foldable

Table base

The aluminum table bases are ideal for outdoors. To protect the table tops and to save space, the table tops can be folded by 90°.

Material: Anodised aluminum. Suitable for outdoors! UV and weather-resistant! Incl. screws to compensate for ground irregularities. 3-year availability guarantee!

	WxLxH cm	Weight kg	Max. rec. table top size cm	Ref.	Piece €
12 TAIPA	66x66x72	7.0	Ø 80, LxW 70x70	10095048	74,99
13 ANEGO	45x45x72	7.5	Ø 80, LxW 70x70	10094663	74,99

Easy assembly, delivered disassembled.



Bench pad
EXPOSE
29⁹⁹

- Water-repellent
- UV-resistant



Bench pad EXPOSE

This comfortable and perfectly fitting all-weather pad for the bench EXPOSE is ideal for outdoors! The foam dries very fast thanks to its special Quick-Dry-Foam® technology. Cover removable.

Cover: 100% polypropylene. 30 °C washable. Weatherproof! Water-repellent!

	LxWxH cm	Color	Ref.	Piece €
1	180.0x30.0x	black mottled	10089408	29,99
2	3.5	natural mottled	10089407	29,99



■ Color: Walnut

NEW



■ Color: Chestnut



Furniture series EXPOSE

This high-quality, modern table-bench set meets all requirements. It is quick and easy to assemble and disassemble due to the easy handling of the folding mechanism and stackable. The sturdy, galvanized and anthracite powder-coated steel frame is as weatherproof and water-repellent as the table and bench slats made of sturdy ash with a thickness of 3,0 cm. Choose between chestnut or walnut lacquered.

Material frame: Steel, powder-coated. Slats: Ash, lacquered. Weatherproof! High-quality workmanship! Space-saving! Suitable for outdoors! Stacking protection! 3-year availability guarantee!

	LxWxH cm	Weight kg	Color	Ref.	Piece €
3 Table	180.0x60.0x76.5	33.0	chestnut	10089409	229,00
4			walnut	10070791	229,00
5 Bench	180.0x30.0x48.0	16.5	chestnut	10089410	139,00
6			walnut	10075002	139,00
7 NEW Bench with backrest	180.0x46.0x81.0	24.5	chestnut	30023914	229,00
			walnut	30023915	229,00



Bench
TOLMINA
199⁰⁰



Furniture series TOLMINA

Solid wood outdoor furniture made of high-quality eucalyptus wood. The surface is well protected with a special varnish for all year outdoor use. Due to the matt finish in the color tobacco the surface looks very natural and of high quality. The panels of the bench are slightly inclined inwards, creating an ergonomic sitting feeling. Ground irregularities can be easily compensated by adjustable feet.

Material: High quality eucalyptus wood, special lacquered. Easy to clean! Suitable for outdoors!



	LxWxH cm	Weight kg	Color	Ref.	Piece €
8 Table	180x65x72	26	antique brown	30003356	399,00
9 Bench	160x33x44	16	antique brown	30003354	199,00



Chair
BAVARIA, from
59⁹⁹

Furniture outdoor

- Water-repellent
- UV-resistant

Seat cushion
BAVARIA
949

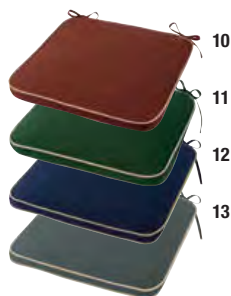

- Foldable
- Solid wood

Table round
BAVARIA
129⁰⁰



Seat cushion BAVARIA

Suitable for chairs fig. 14 - 16. The cushions have a zipper, so the covers can be easily removed. Attachment with 2 fabric straps.

Cover: 100% polyester. 30 °C washable.

Water-repellent and UV-resistant!

Removable!

	WxDxH cm	Color	Ref.	Pcs./ pack	Pack €	Piece €
10	41x41x4	bordeaux	10089246	2	18,98	9,49
11		dark green	10089248	2	18,98	9,49
12		dark blue	10089249	2	18,98	9,49
13		anthracite	10089242	2	18,98	9,49



Beer garden series BAVARIA

The wood elements made of ash are pressure-impregnated, double thick film varnished and with continuous screws. This makes the series weatherproof and extremely robust. The frame made of galvanized and powder-coated steel is equipped with ground-friendly gliders made of plastic.

Material frame: Steel, galvanized and powder-coated. Slats: Ash, pressure-impregnated. Foldable! Easy to clean! Ground-friendly table and chair gliders! Double weatherproof thick film varnish! 3-year availability guarantee!

	Dimension cm	Seat height cm	Weight kg	Ref.	Pcs./pack	Pack €	Piece €
14	WxDxH 41.5x49.0x88.5	46.5	7.0	10089903	2	119,98	59,99
15				10089904	2	139,98	69,99
16	WxDxH 60.5x53.0x101.0	47.0	12.5	10089905	1	-	89,99
17	ØxH 80.0x74.0	-	15.0	10089907	1	-	129,00
18	LxWxH 80.0x80.0x74.0	-	17.0	10089906	1	-	119,00
19	LxWxH 120.0x80.0x74.0	-	20.0	10089908	1	-	149,00



Chair
TOLIA, from
69⁹⁹

- Aluminum in wooden look
- Weatherproof
- Chairs are stackable



Furniture series TOLIA

The chairs are characterized by its special quality. They are made of high-quality aluminum with powder coating and thus weatherproof and ideal for outdoors. Seat and back made of high-density polyethylene in wicker look.

Material: Aluminum, powder-coated. Wickerwork made of polyethylene. Chairs are stackable! Weatherproof! UV-resistant!

	WxDxH cm	Seat height cm	Weight kg	Color (seat)	Color (frame)	Ref.	Pcs./ pack	Pack €	Piece €
1	58.0x58.0x81.5	46	4.2	black	light brown	30040083	2	149,98	74,99
2				NEW dark brown	10080360	2	149,98	74,99	
3				tobacco	10080359	2	149,98	74,99	
4	46.0x55.0x87.5	46	3.8	black	light brown	30040080	2	139,98	69,99
5				NEW dark brown	10080352	2	139,98	69,99	
6				tobacco	10080351	2	139,98	69,99	
7	46.0x57.0x118.0	75	4.4	black	light brown	30040082	2	159,98	79,99
8				NEW dark brown	10080375	2	159,98	79,99	
9				tobacco	10080361	2	159,98	79,99	



Chair without armrest
BASTIA
69⁹⁹

- Light rattan
- Dark rattan



Furniture series BASTIA

The classic and timeless furniture series BASTIA is made of sturdy plastic wickerwork with a frame made of solid wood, optionally in light or dark.

For indoors only. Material: Rattan light/dark, plastic wickerwork, chair glides made of plastic! Stackable!

	WxDxH cm	Seat height cm	Weight kg	Color (seat)	Color (frame)	Ref.	Pcs./ pack	Pack €	Piece €
10	46.0x55.0x87.5	45	5.1	black	beige	10094486	2	139,98	69,99
11				beige/brown	beige	10091028	2	139,98	69,99
12				beige/brown	brown	10091027	2	139,98	69,99
13				beige/red	brown	10091030	2	139,98	69,99
14				beige/dark green	brown	10091029	2	139,98	69,99
15				beige/brown	brown	10091044	2	149,98	74,99
16	beige/red	brown	10091045	2	149,98	74,99			



18

Chair with armrest
RIMALIA
79⁹⁹

> Table base REGULO see p. 348

Lightweight aluminum in noble wooden look

- Stable aluminum
- Weatherproof
- Stackable

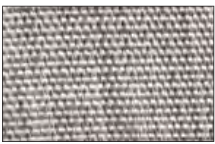

Plastic fabric
grey mottled



Synthetic wickerwork
anthracite



Lounger
RIMALIA
89⁹⁹



Furniture series RIMALIA

A perfect combination of modern design and high-quality workmanship! The frame of these chairs looks like noble wood, but is made of powder-coated aluminum. This makes the chairs not only lightweight, but also robust and weather-resistant - making them ideal for outdoor catering. The seat and back are made of weatherproof plastic fabric. The slightly wide seat of the lounge enables ergonomic sitting. Practical: Due to their low weight, all four models are stackable and can thus save space. Plastic glides on the legs protect the ground.

Material: Aluminum, powder-coated. Plastic. Weatherproof! Stackable! 3-year availability guarantee!

		WxDxH cm	Seat height cm	Weight kg	Color	Ref.	Pcs./pack	Pack €	Piece €
17	Chair with	58.0x56.5x82.0	46	3.5	anthracite	30003038	2	159,98	79,99
18	armrest				grey mottled	30003039	2	159,98	79,99
19	Chair with-	46.0x53.0x87.5	46	3.0	anthracite	30003036	2	149,98	74,99
20	out armrest				grey mottled	30003037	2	149,98	74,99
21	Bar chair	56.0x59.0x114.0	78	4.1	anthracite	30003040	2	179,98	89,99
22					grey mottled	30003041	2	179,98	89,99
23	Lounger	64.0x64.0x81.0	46	3.8	anthracite	30003042	2	179,98	89,99
24					grey mottled	30003043	2	179,98	89,99



> Lounger METROPOLITAN see p. 366



> Furniture series METROPOLITAN see p. 362-365



- Water-repellent
- UV-resistant
- Non-slip surface on the underside

1 2 3

Pad MELROSE

On the underside of the pad is a special non-slip PVC coating.

Cover: 100% polyester. 30 °C washable. Water-repellent and UV-resistant!



	LxWxH cm	Color	Ref.	Piece €
1	196x60x5	ecru	10082769	64,99
2		anthracite	10082767	64,99
3		berry	10082768	64,99

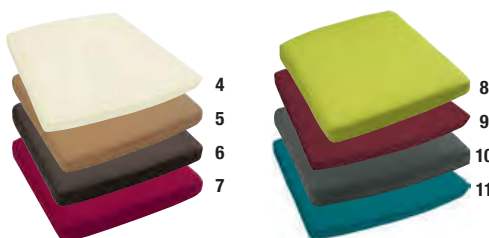

- Water-repellent
- UV-resistant

Seat cushion METROPOLITAN

Suitable for furniture series METROPOLITAN see p. 362 - 365. With zipper, therefore easily removable from the foam filling. Water-repellent and UV-resistant. Suitable for outdoors.



Cover: 100% polyester. 30 °C washable. Filling: Polyether foam.

	WxDxH cm	Color	Ref.	Pcs./pack	Pack €	Piece €
4	42x43x3	ecru	10089294	2	19,98	9,99
5		light brown	10089293	2	19,98	9,99
6		chocolate	10089296	2	19,98	9,99
7		berry	10089292	2	19,98	9,99
8		apple green	10089289	2	19,98	9,99
9		bordeaux	10089291	2	19,98	9,99
10		anthracite	10089290	2	19,98	9,99
11		petrol	10080348	2	19,98	9,99

■ Quick Dry Foam® – fast-drying

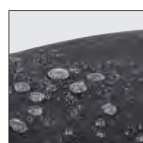

Water-repellent



Allweather seat cushion METROPOLITAN
13,99



Allweather seat cushion METROPOLITAN

Suitable for furniture series METROPOLITAN. The easy-care, removable cover is lightfast, UV-resistant, highly water-repellent and very durable. And the foam padding inside dries extremely fast thanks to the special Quick-Dry-Foam technology. Perfect for any outdoor area!

Cover: 100% polypropylene. 30 °C washable.

	WxDxH cm	Color	Ref.	Pcs./pack	Pack €	Piece €
12	43.0x42.0x2.5	natural mottled	10089358	2	27,98	13,99
13		black mottled	10089363	2	27,98	13,99

Bench pad ALICANTE
28,99



Bench pad ALICANTE

Bench pad suitable for our teak bench ALICANTE (see p. 386). Thanks to a zipper, the cushion cover can be easily removed from the foam filling. Suitable for outdoors.

Cover: 100% polyester. 30 °C washable. Filling: Polyether foam.

	LxWxH cm	Color	Ref.	Piece €
14	138x50x5	ecru	10089238	28,99
15		berry	10089237	28,99

- Water-repellent
- UV-resistant



Seat cushion
LINEARES, from
749

> Aluminum chair LIMONA see p. 385



Seat cushion LINEARES

Available in various colors. Thanks to a zipper, the cushion cover can easily be removed from the foam filling. Dimensions cushion with backrest in total: 41,5x80x3 cm. Suitable for outdoors.

Cover: 100% polyester. 30 °C washable.

Filling: Polyurethane.

Water-repellent and UV-resistant!

Removable!

	without backrest	with backrest
WxDxH cm	42.0x42.0x3.0	41.5x38.5x3.0
beige	16 10089212	24 10089226
orange	17 10089221	25 10089235
light red	18 10089218	26 10089231
bordeaux	19 10089213	27 10089227
Pack of	2	4
Pack €	14,98	41,96
Piece €	7,49	10,49

	without backrest	with backrest
WxDxH cm	42.0x42.0x3.0	41.5x38.5x3.0
dark green	20 10089214	28 10089228
dark blue	21 10089216	29 10089229
mocha	22 10089220	30 10089234
stone grey	23 10089222	31 10089236
Pack of	2	4
Pack €	14,98	41,96
Piece €	7,49	10,49

Like this your guests will enjoy to stay longer

Seat cushion
SELINA

14⁹⁹



Seat cushion SELINA

With 2 wide straps for easy fastening. Cover is removable.

Cover: 100% polyester. 30 °C washable.

Filling: Polyether foam.

	WxDxH cm	Color	Ref.	Pcs./pack	Pack €	Piece €
32	44.0x44x5.0	beige	10082782	2	29,98	14,99
33		dark grey	10082783	2	29,98	14,99

Seat cushion
BAVARIA

9⁴⁹

- Water-repellent
- UV-resistant

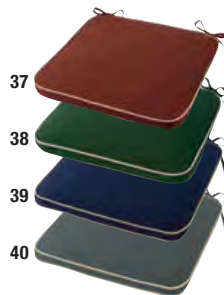

- Water-repellent
- UV-resistant
- Non-slip surface on the underside

Seat cushion
VINCENT

8⁴⁹

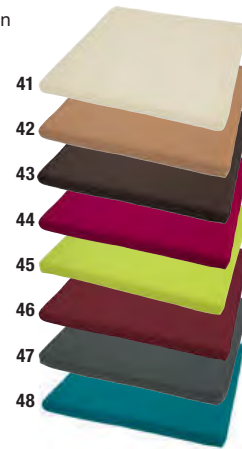

Seat cushion VINCENT

The cover can be easily removed from the foam filling by a zipper. Perfect grip - even without straps, guarantees the non-slip underside made of PVC.

Cover: 100% polyester. 30 °C washable.

Filling: Polyurethane.

Water-repellent and UV-resistant!

	WxDxH cm	Color	Ref.	Piece €
41	40x40x3	ecru	10082778	8,49
42		light brown	10082777	8,49
43		chocolate	10082780	8,49
44		berry	10082776	8,49
45		apple green	10082773	8,49
46		bordeaux	10082775	8,49
47		anthracite	10082774	8,49
48		petrol	10080335	8,49

Seat cushion
COMFORT

7⁴⁹

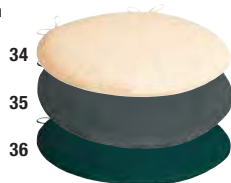

Seat cushion COMFORT

Very comfortable cushion with extra thick foam, removable cover. With straps for easy fastening. Suitable for outdoors.

Cover: 100% polyester. 30 °C washable.

Filling: Polyurethane.

	ØxH cm	Color	Ref.	Pcs./pack	Pack €	Piece €
34	41x4	ecru	10089210	2	14,98	7,49
35		anthracite	10089207	2	14,98	7,49
36		dark green	10089208	2	14,98	7,49



Seat cushion BAVARIA

The cushions have a zipper, so the covers can be easily removed. Attachment with 2 fabric straps.

Cover: 100% polyester. 30 °C washable.

Water-repellent and UV-resistant!

Removable!

	WxDxH cm	Color	Ref.	Pcs./pack	Pack €	Piece €
37	41x41x4	bordeaux	10089246	2	18,98	9,49
38		dark green	10089248	2	18,98	9,49
39		dark blue	10089249	2	18,98	9,49
40		anthracite	10089242	2	18,98	9,49



Reliable sun protection

Granite sunshade base

64⁹⁹

■ With handle



Granite sunshade base

Sunshade base with granite bottom. With an pull-out handle and two rollers, the sunshade base can be easily transported. With adapter for stems up to Ø 58 mm. Suitable for sunshades up to Ø 3 m and 3x3 m.

Weatherproof! With handle! Rollable!

	WxDxH cm	Weight kg	Ref.	Piece €
1	52x52x6	40	10093497	64,99

Easy assembly, delivered disassembled.



Sunshade CIELO
159⁰⁰

■ UV-resistant
■ 6 colors
■ Includes protective cover



Sunshade CIELO made of aluminum

First-class sunshade at an attractive price! UV-resistant sunshade with protective cover with frame made of sturdy, powder-coated aluminum. The stem with Ø 48 mm and eight reinforced struts with WxD 13x22 mm brace the screen for the tough gastronomy routine. The cover with valance consists of 250 g/m² polyester, is water-repellent, lightfast and UV-resistant! Keep closed in strong winds.

Material: 100% polyester.

Easy opening by crank! Includes protective cover! Sturdy struts! UV-protection 50+, lightfast, water-repellent!



Sturdy aluminum struts



Easy opening by crank

	Shape	LxWxH cm	Weight kg	Color	Ref.	Piece €
2	square	300x300x260	5.5	ecru	10089387	159,00
3				red	10089391	159,00
4				sun yellow	10089389	159,00
5				fir	10089390	159,00
6				brown	10089386	159,00
7				anthracite	10089388	159,00



Furniture outdoor



- UV-resistant
- Water-repellent
- 4 colors
- Includes protective cover



Sturdy aluminum struts



Easy opening by crank



Sunshade SIROC made of aluminum

In the compact size of only 2 x 2 m, this high-quality sunshade with protective cover at an attractive price is the best choice if you have only little space, for example on the sidewalk! The small sunshade offers great advantages: The sturdy frame made of powder-coated aluminum, a stem with Ø 48 mm and 8 struts with WxD 13x22 mm can be easily opened with a crank. The highly water-repellent fabric with 250 g/m² made of 100% polyester is UV-resistant 50+ and lightfast. Keep closed in strong winds.

Material: 100% polyester.

Easy opening by crank! Includes protective cover! Sturdy struts! UV-protection 50+, lightfast, water-repellent!

	Shape	LxWxH cm	Weight kg	Color	Ref.	Piece €
8	square	200x200x227	4.5	cream	10082874	129,00
9				burgundy	10082876	129,00
10				brown	10082877	129,00
11				anthracite	10082875	129,00



+49 8272 807 447



service@em-group.com



www.em-group.com



Professional sunshade
ESPARTO
329⁰⁰

Protective cover
49⁹⁹

■ UV-resistant



Protective cover

Suitable for sunshades fig. 2 – 10. Cover with reinforcement strut and zipper, including rod for easy covering over the standing sunshade.

**Material: 100% polyester. Waterproof!
UV-resistant! Easy covering!**

	LxW cm	Color	Ref.	Piece €
1	350x45	grey	10094227	49,99



■ Stem: White

■ Stem: Wooden look

■ Stem: Anthracite

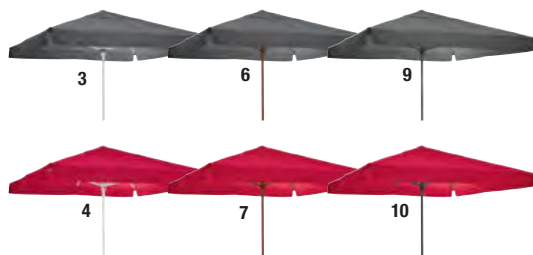

■ Automatic opening and closing
■ 3 colors



Effortless, springsupport-
ed sliding system



Reinforced struts



Available in 3 stem colors

Professional sunshade ESPARTO

Professional large sunshade with extremely sturdy aluminum frame. The frame is powder-coated. The stem with Ø 60 mm and 8 reinforced struts (18x28 mm) give the sunshade the necessary stability. The UV-resistant, lightfast and extremely water-repellent cover with valance made of 230 g/m² polyester provides ideal protection against heat and UV rays. The integrated sliding system is supported by a spring inside the stem. This guarantees effortless opening and closing above the tables. Plastic covers at the end of the struts protect the lining. When opening and closing the large sunshade, watch out for objects and people. The sunshade must be closed at wind strength of 7 m/s. Please order at the same time: Plate base for stem Ø 60 mm.

Material: 100% polyester.

High-quality lining! Reinforced struts! Plastic covers at the end of the struts! UV-protection 50+, lightfast, extremely water-repellent!



	LxWxH cm	Weight kg	Color (stem)	Color	Ref.	Piece €
2	350x350x370	21	white	ecru	10094018	329,00
3				grey	10094021	329,00
4				burgundy	10094220	329,00
5			wooden look	ecru	10093995	329,00
6				grey	10093998	329,00
7			burgundy	10094221	329,00	
8			anthracite	ecru	10008105	329,00
9				grey	10008107	329,00
10				burgundy	10008108	329,00

NEW

12

Double sunshade
LEVANTO

499⁰⁰



Your benefit

Rotatable and swiveling double sunshade: A large space of shade can be created with only a few sunshades.

Furniture outdoor

Flexible shade

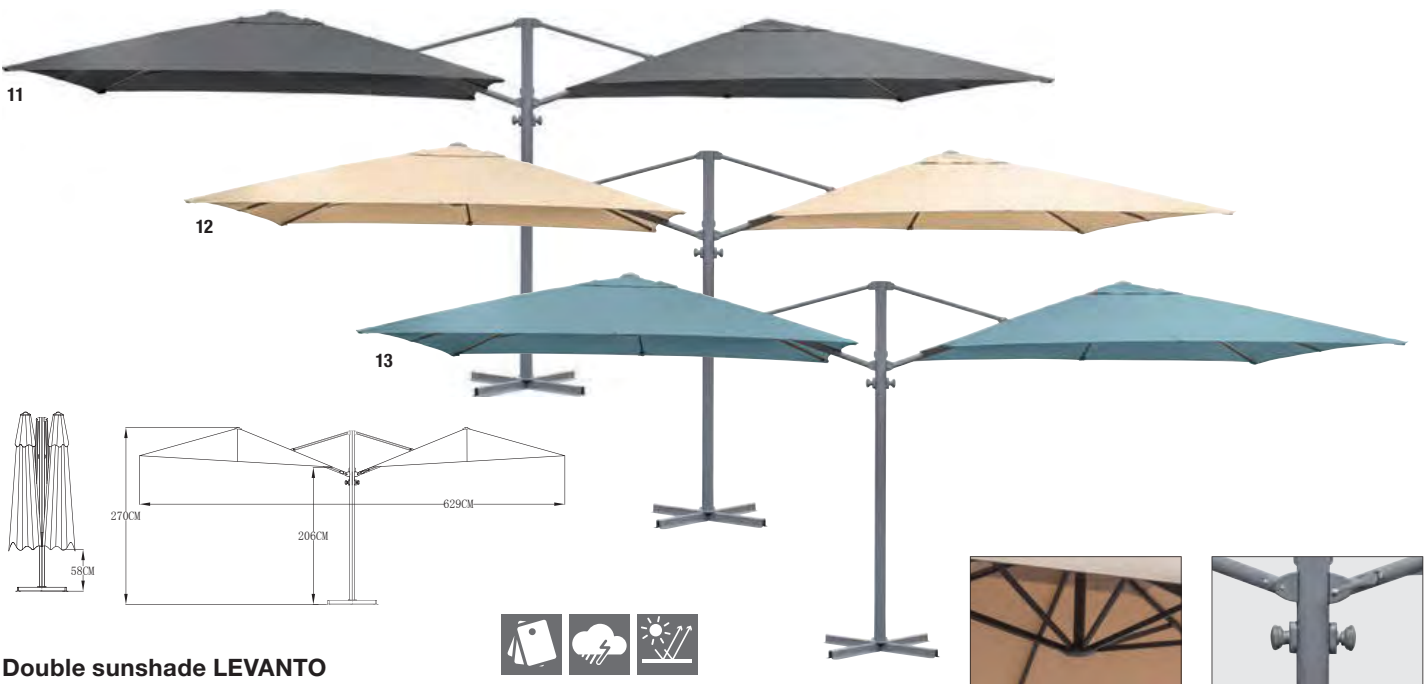

Double sunshade LEVANTO

Double sunshade with span range of two times 3x3 m for a large space of shade. Easy opening and closing by crank. 360° rotatable and 45° swiveling: Like this, your guests always have a place in the shade! Including protection cover and plate sunshade base. The attachment is made by inserting 40x40 cm to 50x50 cm large paving slabs (not included). Rotatable and space-saving.

Material stem: Powder-coated aluminum. **Material fabric:** 100% polyester, 250 g/m², UV-protection 50+. **Lightfast and UV-resistant:** Stays beautiful for a long time! **Water-repellent!**

Sturdy aluminum struts

Easy opening and closing by crank

	LxWxH cm	Weight kg	Color	Ref.	Piece €
11			anthracite	30026512	499,00
12	300x300x270	45	ecru	30026513	499,00
13			turquoise	30026514	499,00



Hanging sunshade
BREVA

339⁰⁰

Hanging sunshade BREVA



Where there is much sun, shadow is desired. A first-class and high-quality shade dispenser is the stable hanging sunshade with a frame made of powder-coated aluminum. The fabric is UV-resistant and lightfast. The water-repellent, tiltable roof surface can be turned 360° with a foot pedal at the end of the stem. A simple opening of the sunshade is guaranteed by a crank. Keep the sunshade closed in strong winds. Including protective cover and stable plate base. The fixing is made by inserting 40x40 cm to 50x50 cm paving slabs (not included in the scope of delivery).

Material: 100% polyester. Powder-coated aluminum! Dimensions of the struts: WxD 14x24 mm! Delivery includes cover! Stem 7x5 cm with material thickness of 2 mm! UV-protection 50+!



Sturdy aluminum struts



Easy adjustment of the screen angle possible



Cast iron swivel with foot pedal

	Shape	LxWxH cm	Weight kg	Color	Ref.	Piece €
1	square	295x295x270	23.2	ecru	10093845	339,00
2				taupe	30039805	339,00
3				grey	10093844	339,00

Sunshade will be delivered mounted, base must be assembled.

6

NEW

Hanging sunshade
ELYO349⁰⁰

> Furniture series TOLMINA see p. 388

Furniture outdoor

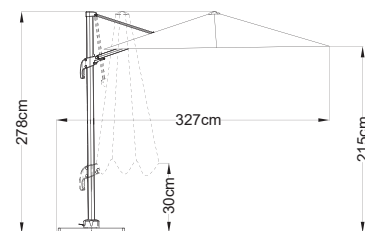
For your terrace or garden**Hanging sunshade ELYO**

Hanging sunshade with span range of 3x4 m for a large space of shade. Easy opening and closing by crank. 360° rotatable and 45° swiveling: Like this, your guests always have a place in the shade! Including protection cover and sunshade base. The attachment is made by inserting 40x40 cm to 50x50 cm large paving slabs (not included in the scope of delivery).

Material stem: Powder-coated aluminum. Material fabric: 100% polyester, 250 g/m², UV-protection 50+. Lightfast and UV-resistant: Stays beautiful for a long time! Water-repellent!

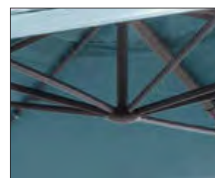

Sturdy aluminum struts



Easy adjustment of the screen angle possible



Cast iron swivel with foot pedal

	Shape	LxWxH cm	Weight kg	Color	Ref.	Piece €
4				anthracite	30026515	349,00
5	rectangular	300x400x275	29	ecru	30026516	349,00
6				turquoise	30026517	349,00

Sunshade will be delivered mounted, base must be assembled.



+49 8272 807 447



service@em-group.com



www.em-group.com

399

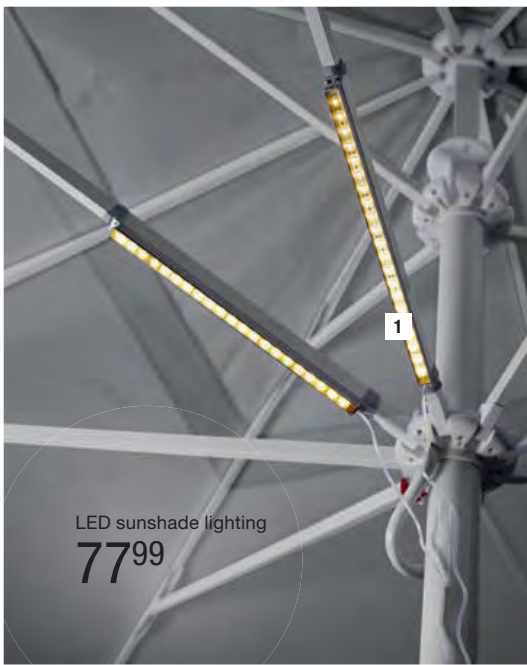

LED sunshade lighting
77⁹⁹



LED sunshade lighting

This light can be easily and quickly installed with the supplied mounting material to every sunshade. The two LED strips with extra bright light never lets your guests sit in the dark. The outdoor suitable supply cable has a length of 15 m and can easily be removed to protect the connections against moisture due to heavy rain. The LED strips as well as the on/off switch are fastened with velcro straps and do not interfere with the closing or opening of the sunshades. Connected load 230 V. Supplied with LEDs of energy class A.



	1
Number LED strips	2
LxWxH	35.5x1.7x2.0 cm
Connected load	8.4 W / 230 V
Color	silver / transparent
Ref.	10094609
Set €	77,99

Plate sunshade base

44⁹⁹



Plate sunshade bases

Made of galvanized, powder-coated steel. Suitable for sunshades with a stem diameter of max. 60 mm. The fixing is made by inserting 50x50 cm large sidewalk panels (not included in the scope of delivery).

Weatherproof! Stable!

	LxW cm	Color	Ref.	Piece €
2	101x101	white	10093999	44,99
3		anthracite	10070533	44,99

Easy assembly, delivered disassembled!

Sunshade base from

52⁹⁹

■ With handle



Sunshade base

Made of robust and weatherproof polymer concrete. The sunshade bases are equipped with handles, the angular also with rollers. Includes adapter for stems up to Ø 58 mm. Suitable for sunshades up to Ø 3 m and 3x3 m.

Weatherproof! With handles! Rollable!

	Shape	Dimension cm	Weight kg	Ref.	Piece €
4	round	ØxH 55x9	40	10094706	52,99
5	angular	WxDxH 55x55x8	50	10097703	62,99

Easy assembly, delivered disassembled.

Granite sunshade base

64⁹⁹

■ With handle



Ground stem

52⁹⁹



Granite sunshade base

Sunshade base made of granite. With a pull-out handle and two rollers, the sunshade base can be easily transported. With adapter for stems up to Ø 58 mm. Suitable for sunshades up to Ø 3 m and 3x3 m.

Weatherproof! Mit Griff! Rollbar!

	WxDxH cm	Weight kg	Ref.	Piece €
6	52x52x6	40	10093497	64,99

Easy assembly, delivered disassembled!

Ground stem

Made of galvanized steel. Only the upper part (51 cm) is inserted into the lower, concreted part of the ground stem (40 cm) to install a sunshade. Thus, the ground stem protrudes 32 cm from the ground and stems up to Ø 60 mm can be inserted. If no sunshades are needed, the upper part is removed and the hole is closed with a closure cover. The required concrete foundation for the ground stem must be at least 50x50x50 cm and guarantees a safe position of the sunshade.

Weatherproof! Includes cover lid! Stainless!

	ØxH cm	Ref.	Piece €
7	6x72	10094347	52,99



Wire rope, from
9⁹⁹

9

10

Wire rope and accessories

4 mm thick wire ropes with 2 mm PVC covering and pressed loops at the ends. The galvanized connector allows you to connect several ropes together. Enter your personal code in the brass number combination lock..

	L m	Ref.	Piece €
8	3	10090416	9,99
Wire rope	6	10090417	11,99
	9	10090418	14,99
9 Connector	-	10090419	1,99
10 Lock	-	10090420	8,99

Standing ashtray
59⁹⁹



Standing ashtray

Standing ashtray with waste bin and removable sand screen. The waste bin holds 15 l.

Material: Steel sheet, lacquered. Suitable for protected outdoor areas!

	ØxH cm	Weight kg	Ref.	Piece €
11	26x82	4	10053030	59,99

Standing ashtray
79⁹⁹



Standing ashtray

With sand screen and waste bin. The delivery includes sand (1 kg)! The waste bin holds 40 l. The compact design ensures a safe stand.

Material: Steel sheet, lacquered. Suitable for protected outdoor areas!

	ØxH cm	Weight kg	Ref.	Piece €
12	31x80	7.5	10053032	79,99

Standing ashtray
31⁹⁹



Standing ashtray

With waste bin and removable ashtray. The waste bin holds 14 l.

Material: Steel. Suitable for protected outdoor areas!

	ØxH cm	Weight kg	Ref.	Piece €
13	24.0x58.5	1.6	10059586	31,99

Wall ashtray
29⁹⁹



Wall ashtray

Made of powder-coated steel. Easy and quick emptying thanks to the removable ash insert. 2-point fixing. Capacity: 1 l. Delivery includes mounting material.

Material: Steel, powder-coated. Suitable for protected outdoor areas!

	WxHxD cm	Ref.	Piece €
14	25x15x13	10022250	29,99

Wall ashtray
89⁹⁹



Wall ashtray

With rain cover. Grey side walls made of aluminum. Easy and quick emptying by triangular key. A vandal-proof 4-point fixing is possible. Capacity: 2 l. Delivery includes key, but no mounting material.

Material: Steel, powder-coated. Weatherproof!

	WxHxD cm	Ref.	Piece €
15	23.0x28.2x6.0	10053092	89,99

Ashtray, from
87⁹⁹



Ashtray

Practical and fast emptying by simply removing. Delivery without mounting material. Capacity: 3 l.

Material: Steel, powder-coated. Weatherproof!

	WxHxD cm	Ref.	Piece €	
16	Wall ashtray	12x55x5	10022251	87,99
17	Standing ashtray	25x96x10	10022252	165,00

Standing ashtray
329⁰⁰



Standing ashtray

With rain cover. Grey side walls made of aluminum. Easy and quick emptying by triangular key. Delivery includes key, but no mounting material. With waste bin. Vandal-proof 4-point fixing. Capacity: 30 l, ashtray: 5 l.

Material: Steel, galvanized. Weatherproof!

	WxHxD cm	Weight kg	Ref.	Piece €
18	30x96x25	17.9	10053093	329,00

Ashtray from
3¹⁹



Ashtrays

Material: Hotel porcelain. Dishwasher safe!

	ØxH cm	Ref.	Pcs./pack	Pack €	Piece €
19	12.0x5.0	10012093	6	20,34	3,39
20	9.0x3.5	10011831	6	19,14	3,19

Glass Ashtray
0⁷⁹



Glass ashtray

Stackable.

Material: Glass. Dishwasher safe! Weatherproof!

	ØxH cm	Ref.	Pcs./pack	Pack €	Piece €
21	10.0x3.3	20060081	18	14,22	0,79

Wind ashtray
4⁹⁹



Wind ashtray

Material: Chrome-nickel stainless steel 18/8. Weatherproof!

	ØxH cm	Ref.	Piece €
22	11x6	10070359	4,99



1

Infrared radiant heater ATACAMA for sunshades

199⁰⁰

- Especially for sunshades
- With built-in lighting
- Foldable



1



Infrared radiant heater ATACAMA for sunshades

Extend the outdoor season for your guests and create pleasant temperatures even in cold weather with this radiant heater. The infrared radiant heater with a power of 3 x 660 watts can be comfortably mounted on a sunshade (tube diameter 3.8-5.8 cm) and provides immediate, homogeneous heat. It can be easily regulated with a toggle switch. Mounting material is included. Infrared tube: Gold tube Ultra Low Glare. Suitable for protected outdoor areas.

Material: Aluminum housing with protective grid.

2 years warranty. CE mark.

Suitable for protected outdoor areas!

	1
LxWxH (open)	92x80x20 cm
LxWxH (closed)	35x35x52 cm
Connected load	3 x 660 W / 220-240 V
Heating time	10 seconds
Lifespan of the tube	3000 hours
Heating area	4.5 m ²
Cable length	1.8 m
Protection class	IP 44
Weight	4 kg
Ref.	30003488
Piece €	199,00



Sunshades can be found at

www.em-group.com



Control via Bluetooth

- Free VEGA smartphone app
- Remote control of the radiant heater with the smartphone
- Bluetooth system with 20 m range



The infrared radiant heaters SAHARA, TARIA, PATAGONIA and SONORIA are equipped with Bluetooth so you can control the radiant heaters with your smartphone. Practical: The Bluetooth system allows you to operate several radiant heaters at the same time, turn them and also play music on certain models. You can download the necessary, password protected smartphone app in our online shop for free. Our infrared radiant heaters are compatible with Android smartphones from version 4.3 and Apple iPhones from iOS 7.

Infrared radiant heater SAHARA

259⁰⁰

- Adjustable via smartphone or remote control
- Timer function
- 6 heating levels



2

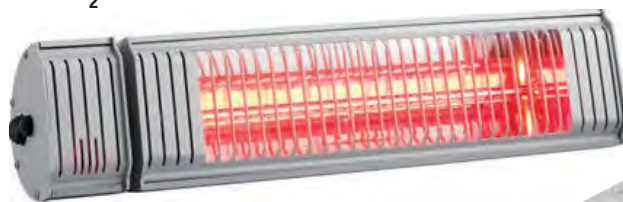

3



Infrared radiant heaters SAHARA and TARIA

Easily control your infrared radiant heater with your smartphone! The radiator with the aluminum housing is available with a power of 1500 W or 2000 W and can be regulated either via remote control or smartphone app which is password protected. With the remote control, five heating levels are possible, via the app the radiant heater can be controlled stepless from 0 to 100%. Especially important for the gastronomy: Via the app, up to 100 infrared radiant heaters can be controlled simultaneously or independently of each other. So your guests can still sit outside comfortably even in cooler weather - and that without long heating of the radiant heaters! Infrared tube: Gold tube Ultra Low Glare. Wall and ceiling mounting, mounting material is included. For indoor and protected outdoor areas.

Material: Aluminum housing with protective grid.

2 years warranty. CE mark.

Suitable for indoor and protected outdoor areas!

	2 SAHARA	3 TARIA
WxHxD	55.6x17.5x13.0 cm	55.6x17.5x13.0 cm
Connected load	1500 W / 220-240 V	2000 W / 220-240 V
Heating time	10 seconds	10 seconds
Lifespan of the tube	3000 hours	3000 hours
Heating area outdoor/indoor	6-12 m ² / up to 25 m ²	6-12 m ² / up to 25 m ²
Cable length	1.9 m	1.9 m
Reach remote control / bluetooth	6 m / 20 m	6 m / 20 m
Protection class	IP 65	IP 65
Weight	2.5 kg	2.5 kg
System requirements app	Android from Version 4.3, iOS Apple from Version 7	Android from Version 4.3, iOS Apple from Version 7
Ref.	30003489	30003487
Piece €	259,00	289,00



Infrared radiant heater
PATAGONIA
329⁰⁰

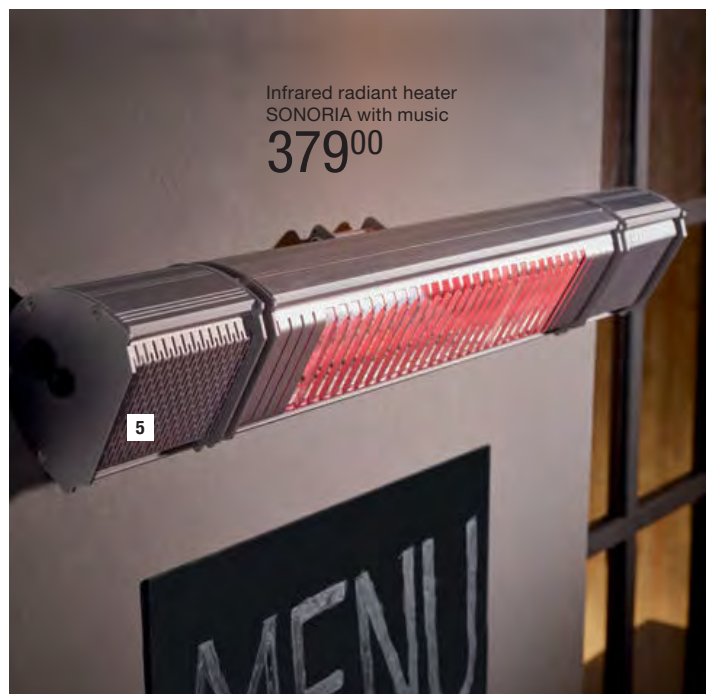

Infrared radiant heater
SONORIA with music
379⁰⁰



Sit outside in cold temperatures

- Adjustable via smartphone or remote control
- Right/left oscillating
- 6 heating levels

- 2 speakers
- Atmospheric backlight
- Adjustable via smartphone or remote control
- 6 heating levels



Infrared radiant heater PATAGONIA oscillating

This infrared radiant heater swings from right to left and thus ensures optimum heat distribution. The housing of the heater is made of aluminum, it can be controlled via remote control or smartphone app. With the remote control, six heating levels are possible, via the app the radiant heater can be controlled stepless from 0 to 100%. In addition, several infrared radiant heaters can be controlled simultaneously via the app, also independently of each other, and programmed with a timer function. Mounting material is included. Infrared tube: Gold tube Ultra Low Glare. Oscillation: Rotatable 30° left and right, permanent oscillation possible.

Material: Aluminum housing with protective grid.
2 years warranty. Wall or ceiling mounting.

CE mark. Suitable for indoor and protected outdoor areas!

	4
WxHxD	74.0x13.0x13.5 cm
Connected load	2000 W / 220-240 V
Heating time	10 seconds
Lifespan of the tube	3000 hours
Heating area outdoor/indoor	6-12 m ² / up to 25 m ²
Cable length	1.9 m
Reach remote control / bluetooth	6 m / 20 m
Protection class	IP 65
Weight	3.9 kg
System requirements app	Android from Version 4.3, iOS Apple from Version 7
Ref.	30003490
Piece €	329,00



Infrared radiant heater SONORIA with music

The SONORIA infrared radiant heater with bluetooth system combines 3 devices in 1, which you can control via your smartphone. With infrared tubes that produce a strong, instantaneous and homogeneous heat. It is equipped with 2 speakers for streaming music from the smartphone and has 4 LED strips for music-sensitive backlight, which you can customize like you desire. With your smartphone you can vary the power from 1 to 100%, control up to 100 heaters simultaneously and program with the timer function. The app on the smartphone is password protected. SONORIA is also equipped with a remote control that provides 6 heating levels. It is swiveling and offers 2 mounting options: Wall or ceiling mounting, mounting material is included.

Material: Aluminum housing with protective grid.
2 years warranty. Wall or ceiling mounting.

CE mark. Suitable for indoor and protected outdoor areas!

	5
WxHxD	74.0x13.0x13.5 cm
Connected load	2000 W / 220-240 V
Heating time	10 seconds
Lifespan of the tube	3000 hours
Heating area outdoor/indoor	6-12 m ² / up to 25 m ²
Cable length	1.9 m
Reach remote control / bluetooth	6 m / 20 m
Protection class	IP 65
Weight	3.9 kg
System requirements app	Android from Version 4.3, iOS Apple from Version 7
Ref.	30003491
Piece €	379,00

Versatility means always having
the right items close at hand.



Clearing trolley
ODISSEO, from

293⁹⁹
(p. 330)

> Plate ALESSIA, p. 54 – Salt and pepper shaker KAYU, p. 145 – Glass SINY, p. 117 – Carafe HANNAH, p. 187
Universal glass SURINA, p. 172 – PORTLAND with cutlery holder p. 217 – Clipboard UNICO, p. 439

VEGA

JOBELINE

Parceiro exclusivo



www.DAUTI.pt

Hotelwäsche
Erwin Müller

pulsiva

Rua Nova, 420 | 4570-074 Balasar | Portugal Tel. +351 252 954 026 Fax. +351 252 955 335 | comercial@dauti.pt