

FURNITURE OUTDOOR

Robust, weatherproof, easy to clean

Chair
ESPERIA

99⁹⁹



Seat incl. removable seat cushion

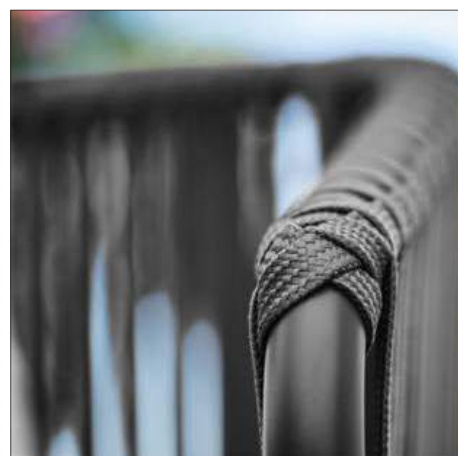

Backrest made of Rope wickerwork

Chair ESPERIA

Modern outdoor chair made of an attractive material mix of aluminum and rope wickerwork. Very comfortable and robust. Delivered assembled. Incl. seat cushion made of olefin fabric (100 % polypropylene).

Material frame: Powder-coated aluminum. Material backrest: Rope wickerwork (15 mm wide). Easy to clean! Stackable! Weatherproof!



	Stack-able	WxDxH cm	Seat height cm	Armrest height cm	Weight kg	Color	Ref.	Pcs./pack	Pack €	Piece €
1	yes	58x62x82	48	68	5	anthracite	30046953	2	199,98	99,99
2	yes	58x62x82	48	68	5	olive	30046954	2	199,98	99,99



> Table top LIFT see p. 321

- Stackable
- Great material mix



Chair series AMELIA

Outdoor chair in an attractive material mix. With seat made of Batyline® fabric and backrest made of natural-looking Rope wickerwork. These materials make the chairs durable, UV-resistant and allow them to dry quickly - ideal for use in the garden or on the terrace! Very comfortable thanks to the soft seat and ergonomically curved backrest: No additional seat cushion required. Incl. exchangeable plastic glides.

Material frame: Aluminum with high-quality powder-coating. Material seat: Textilene fabric.

Material backrest: Rope (98 % polypropylene + 2 % polyester yarn).

Weatherproof, UV-resistant, stackable and lightfast for outdoor use!



Backrest made of Rope wickerwork



Seat made of Textilene fabric

	WxDxH cm	Stack-able	Seat height cm	Armrest height cm	Weight kg	Color	Ref.	Pcs./ pack	Pack €	Piece €
1 Chair without armrest	53x55x78.5	yes	44		3	anthracite	30040097	2	179,98	89,99
2 Chair with armrest	59x56x78.5	yes	44	64.5	4	anthracite	30040090	2	199,98	99,99
3 Bar chair	56x55x112.5	yes	80		4.5	anthracite	30040092	2	278,00	139,00



Chair
TACOMA
64⁹⁹

- Stackable
- Great material mix



Chair TACOMA

A real eye-catcher with high design standards. Comfortable outdoor chair with a generous seating area and comfortable backrest made of dense, hard-wearing wickerwork. Space-saving stackable up to 5 pieces. For even more comfort, please order the matching seat cushion LINEARES at the same time.

Material frame: Robust, powder-coated aluminum. Material seat: Textilene fabric. Material backrest: Rope (98 % polypropylene + 2 % polyester yarn). Durable! Very comfortable! Stackable!

	WxDxH cm	Stack- able	Seat height cm	Armrest height cm	Weight kg	Color	Ref.	Pcs./ pack	Pack €	Piece €
4	57x64x73	yes	45	67	3.2	anthracite	30044714	2	129,98	64,99



Seat made of Textilene fabric

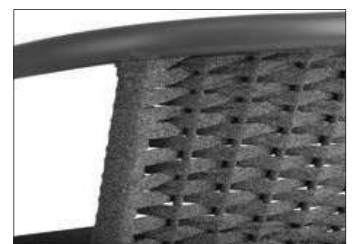

Backrest made of Rope wickerwork

FURNITURE SERIES FILEA

Weatherproof, stackable, comfortable and innovative - the furniture series FILEA is perfect for indoors and outdoors. It is not only convincing due to its modern design, but is also very stable. The seat made of high-quality Rope wickerwork is responsible for the high level of comfort. The result: Seating furniture with charm that invites your guests to order another drink.

VEGA Favorites



Chair FILEA
anthracite
WxDxH cm 58x56x87
Ref. 30002031
Pcs./pack 4
Pack € 319,96
Piece € 79,99

Chair with armrest FILEA
anthracite
WxDxH cm 58x56x87
Ref. 30002036
Pcs./pack 4
Pack € 359,96
Piece € 89,99

Bar chair FILEA
anthracite
WxDxH cm 62x60x108
Ref. 30002004
Pcs./pack 2
Pack € 218,00
Piece € 109,00



Lounger
FILEA
105⁰⁰
(p. 342)

An inviting trendsetter



UV-resistant: Stays beautiful for a long time and does not fade



Comfortable: Your guests will enjoy sitting for a longer time!



Stackable for space-saving storage



- Comfortable
- Stackable
- UV-resistant

Bar chair
FILEA
109⁰⁰



Galvanized steel frame



Comfortable due to dense Rope wickerwork



Chair glides with anti-scratch function



Chair series FILEA

The innovative furniture series FILEA enriches every outdoor area. Whether as a chair with or without armrest, as a bar chair, lounge or stool - the weatherproof and stackable seating elements are not only convincing due to their modern design. They also stand on very stable frames made of powder-coated steel with plastic glides and make sitting comfortable thanks to a very dense Rope wickerwork made of a hard-wearing mix of polypropylene and polyester, which appears very natural in its feel and appearance.

Material: Powder-coated galvanized steel, 98 % polypropylene and 2 % polyester yarn. Rope wickerwork quick-drying! Durable!

	Stack-able	Armrest height cm	WxDxH cm	Seat height cm	Weight kg	Color	Ref.	Pcs./pack	Pack €	Piece €
1	yes	68	58x56x87	47	4.5	anthracite	30002036	4	359,96	89,99
2						beige	30002037	4	359,96	89,99
3						plum	30043464	4	359,96	89,99
4	yes		58x56x87	47	3.9	anthracite	30002031	4	319,96	79,99
5						beige	30002013	4	319,96	79,99
6						plum	30043462	4	319,96	79,99
7	yes		62x60x108	72	4.9	anthracite	30002004	2	218,00	109,00
8						beige	30001999	2	218,00	109,00
9						plum	30043461	2	218,00	109,00
10			73.5x67x75	42	5	anthracite	30001996	2	210,00	105,00
11						beige	30001994	2	210,00	105,00
12						plum	30043463	2	210,00	105,00

Chair with armrest
FILEA

89⁹⁹



1

> Teak table top LUIGI see p. 379

Furniture outdoor



4

5



12

Lounger
FILEA
105⁰⁰



Armchair
VENTURA
279⁰⁰

- Easy to clean
- Incl. cushion



1



2



Longe furniture series VENTURA

Outdoor armchair and sofa in an attractive design - perfect for your outdoor area or indoor lounge. A special finish protects the solid wood frame for year-round use. With cushions made of high-quality, natural-looking and weather-resistant olefin fabric. Very comfortable thanks to the generous seat. The sofa is suitable for three people. Easy to clean, uncomplicated assembly - just attach the feet to the frame!

Material frame: FSC® certified solid eucalyptus wood.

Material seat frame: Galvanized steel, braided with Rope wickerwork. Material cushion: Olefin fabric (100 % polypropylene). Weatherproof! UV-resistant!

	WxDxH cm	Seat height cm	Weight kg	Ref.	Piece €
1 Armchair	82x78x72	37.5	13	30047075	279,00
2 3-seater sofa	169x78x72	37.5	22.5	30047076	499,00



Great material mix

TREND



> Chair ESPERIA see p. 337

Furniture outdoor

- Aluminum fiber cement
- Easy to clean
- Combinable



Side table
AVOLA

99⁹⁹



Table AVOLA

Table with diagonally flared legs in Nordic design. With solid wood frame and special lacquer finish - the table is perfectly protected for year-round outdoor use! Very robust and weather-resistant table top (table top thickness: 13 mm) made of high-quality and resistant aluminum fiber cement. With adjustable plastic glides. Suitable for indoors and outdoors. Very easy and fast assembly. Can perfectly combined with many other VEGA furniture.

Material frame: FSC® certified solid eucalyptus wood.
Material table top: Aluminum fiber cement. Easy to clean! Weather-proof! UV-resistant!



	WxDxH cm	Weight kg	Ref.	Piece €
3 Side table	80x50x40	10.5	30046700	99,99
4 Table	80x80x75	17	30046699	179,00
5 Table	140x80x75	27.5	30046698	279,00



Chair
RAFIA
89⁹⁹

- Easy to clean
- Weatherproof



Chair RAFIA

Robust outdoor chair in a great color and material mix of aluminum and Rope wickerwork. Elegant look due to the natural-looking, elaborately braided and resistant seat. Very comfortable - no additional seat cushion necessary! Plastic glides protect the chair and the floor.

Material frame: Powder-coated aluminum. Material seat: Rope wickerwork. Delivered assembled! Easy to clean! Stackable! Weatherproof!

	WxDxH cm	Stack-able	Seat height cm	Weight kg	Color	Ref.	Pcs./pack	Pack €	Piece €
1	56x46x86	yes	46	4.2	anthracite	30046713	2	179,98	89,99
2	56x46x86	yes	46	4.2	light grey	30046714	2	179,98	89,99



Seat Rope wickerwork



Stackable

TREND



Furniture outdoor

Seat cushion
TOMEO, from
14⁹⁹



Chair
TOMEO
119⁰⁰



Longe furniture series TOMEO

Lounge furniture in an attractive material mix of trendy polyrattan and aluminum. The frame made of high-quality, powder-coated aluminum looks like real bamboo wood and fits into any outdoor or indoor area. Plastic glides on the underside protect the floor. Please order matching seat cushions made of high-quality olefin fabric at the same time!

Material frame: Powder-coated aluminum. Material seat: Polyrattan wickerwork. Material pillow cover: Olefin fabric (100 % polypropylene). For indoor and outdoor use. Easy to clean! Weatherproof!



Bamboo look frame



Attractive material mix

	WxDxH cm	Seat height cm	Armrest height cm	Weight kg	Ref.	Pcs./pack	Pack €	Piece €
3 Chair	60x62x83	45	63	5.5	30053872	2	238,00	119,00
4 Armchair	81x73x82	42	61	6.5	30051267	1	149,00	149,00
5 2-seater	134x73x82	42	61	10	30051260	1	199,00	199,00
	LxWxH cm	Ref.	Pcs./pack	Pack €	Piece €			
6	48x40x5	30053873	2	29,98	14,99			
7 Seat cushion	50x55x4	30051255	1	19,99	19,99			
8	100x55x4	30051268	1	39,99	39,99			

Side element
SERENO

279⁰⁰



> Decorative pillows at www.em-group.com



1



2

Lounge table
SERENO
89⁹⁹



5

- Individually usable
- UV-resistant



Rear view



3



4



Lounge series SERENO

Lounge series in attractive, modern design - an eye-catcher from all sides! Versatile, can be arranged at will. Simple linking of the individual elements (connectors already included in the products). Table with table top made of glass with stone look coating. Cushions included.

Material frame: Robust aluminum, surface powder-coated. Material cushion: High-quality, natural-looking olefin fabric (100 % polypropylene).

Water-repellent! Lightfast! UV-resistant and weatherproof!

	WxDxH cm	Seat height cm	Armrest height cm	Weight kg	Ref.	Piece €
1 Corner element	67.5x67.5x64	43		5	30045121	189,00
2 Middle element	60x69.5x64	43		4	30045123	149,00
3 Side element right	127x69.5x64	43	64	8.5	30045124	279,00
4 Side element left	127x69.5x64	43	64	8.5	30045122	279,00
5 Lounge table	50x70x40			5.5	30045125	89,99

Lounge series
AMALFIA, from
429⁰⁰



> Carpet DANEL see p. 384



Table
AMALFIA
169⁰⁰

- Individually usable
- Easy to clean



Rear view of the cushion attachment

Examples of possible combinations:



Total price €: 1.196,00



Total price €: 1.027,00



Total price €: 858,00



Lounge series AMALFIA

Whether for terrace, spa or wellness area: The lounge system AMALFIA fulfils all wishes! Lounge element and table in an attractive material mix of powder-coated aluminum and teak. Cushions made of high-quality, very weather-resistant and easy-care olefin fabric. Since the elements can be flexibly combined, you can assemble and link your outdoor lounge as you like. A lounge element consists of a frame, a seat cushion and two back cushions as well as linking devices. Easy assembly. The backrest can be moved. Can also be used as a single or double lounger.

Material frame: Powder-coated aluminum and FSC® certified teak.
Material cushion: Olefin fabric (100 % polypropylene). Easy to clean!
Weatherproof!



	WxDxH cm	Seat height cm	Weight kg	Ref.	Piece €
6 Lounge element	172x72x73	42.5	20.5	30045440	429,00
7 Table	72x72x33		7.5	30045439	169,00
Additional element	70x20x58		2.2	30067016	59,99



> Decanter HANNAH see p. 139

- Easy to clean
- Weatherproof



Furniture series PAVONIA

Modern furniture series with chairs and tables made of aluminum. Very space-saving - perfect for any street café! Tables with adjustable plastic glides. The trendy colors can be wonderfully combined with each other. Easy assembly. The seat of the chair has a diameter of 44.0 cm.

Material: High-quality, powder-coated aluminum. Weatherproof! Easy to clean! UV-resistant!

	Dimensions cm	Seat height cm	Weight kg	Color	Ref.	Pcs./ pack	Pack €	Piece €
1				blue	30046709	4	259,96	64,99
2 Chair	46x49x83 (WxDxH)	46	3	green	30046708	4	259,96	64,99
3				anthracite	30046712	4	259,96	64,99
4				blue	30046696	1	109,00	109,00
5 Table	70x73 (ØxH)		5.8	green	30046697	1	109,00	109,00
6				anthracite	30046695	1	109,00	109,00



> Wine glass LOTTA see p. 130, 131

Chair
GIMANI
79⁹⁹

- Easy to clean
- Weatherproof



7



11



12



13

Side table
GIMANI
149⁰⁰



8



9



10

Furniture series GIMANI

Innovative outdoor furniture series with chairs and tables. Chair and table legs made of aluminum in real wood look, seat shell made of resistant plastic in several colors. Table top made of durable Duraboard, a mixture of wood chips and polyethylene resins. An additional multi-layer coating makes the surface very robust and weatherproof. Plastic glides on the legs protect the floor. Also suitable for indoor use. Very simple assembly, the legs are simply screwed to the seat shell or table top.

Material chair and table legs: High-quality, powder-coated aluminum.

Material seat shell: Plastic. Material table top: Duraboard.

Easy to clean! Weatherproof! UV-resistant!



		Dimensions cm	Seat height cm	Weight kg	Color	Ref.	Pcs./ pack	Pack €	Piece €
7	Chair	53x55.5x79.5 (WxDxH)	45	4.5	black	30046758	4	319,96	79,99
8					olive	30046757	4	319,96	79,99
9					pink	30046754	4	319,96	79,99
10					mustard	30046766	4	319,96	79,99
11	Table square	80x80x72 (LxWxH)		14	anthracite	30046755	1	169,00	169,00
12	Table rectangular	130x80x72 (LxWxH)		20	anthracite	30046753	1	199,00	199,00
13	Side table	80x80x48 (LxWxH)		12	anthracite	30046756	1	149,00	149,00

**BEST
SELLER**

Chair
SUNNY

57⁹⁹

- Foldable
- Weatherproof



Furniture series SUNNY

Ingeniously simple: These round or square folding tables and the matching folding chairs are true classics among outdoor furniture. What distinguishes them is their first-class material made of galvanized steel, their long service life and their weather-resistance. Thus optimally suitable for your outdoor area.

Material: Steel, powder-coated and galvanized. Table top height: 3.5 cm. Weatherproof! Foldable! Legs with plastic caps!

	WxDxH cm	Seat height cm	Weight kg	Color	Ref.	Pcs./pack	Pack €	Piece €
1				anthracite	10094356	2	115,98	57,99
2 Chair	42.5x45.5x81	44.5	4.8	blue	10094357	2	115,98	57,99
3				green	10094358	2	115,98	57,99

	Dimensions cm	Weight kg	Color	Ref.	Piece €
4			anthracite	10094364	139,00
5 Table round	80x74 (ØxH)	10.1	blue	10094365	139,00
6			green	10094366	139,00
7			anthracite	10094360	129,00
8	50x70x74 (LxWxH)	8.1	blue	10094361	129,00
9			green	10094362	129,00
10 Table rectangular	70x110x74 (LxWxH)	16.4	anthracite	10008420	199,00
11			blue	10008422	199,00
12			green	10008421	199,00

Easy assembly, delivered disassembled, incl. mounting material for our table tops.

- With magnet
- Waterproof
- UV-resistant



Seat cushion
SUNNY
19⁹⁹

Seat cushion SUNNY

Add our seat cushion to the chairs SUNNY and offer your guests optimum seating comfort. The cushions are made of a waterproof and extremely weather and UV-resistant fabric. Inside there is a strong magnet, so they remain firmly on the seat and do not slip. Easy to clean with a soft cloth and mild detergent.

Material: 70 % polychloride, 30 % polyester. Filling: Polyester. Waterproof! Weather and UV-resistant! Magnet inside!

	LxWxH cm	Color	Ref.	Pcs./pack	Pack €	Piece €
13		green	10094431	2	39,98	19,99
14	28x40x1.5	blue	10094433	2	39,98	19,99
15		anthracite	10094435	2	39,98	19,99



Chair
ATELIO
89⁹⁹

- Chair stackable
- UV-resistant
- Easy to clean



16



19



22



17



20



23



18



21



24

Airy vintage ambience



Furniture series ATELIO

A furniture series that inspires with its vintage look and at the same time fulfils all modern demands of the gastronomy - that is ATELIO. The chairs and tables are presented in an attractive design and are available in trendy colors, which can also be beautifully combined. A special surface makes the tables particularly easy to clean. The furniture is made of high-quality powder-coated aluminum and is therefore very robust and insensitive to wind and weather. They also blend harmoniously into any indoor vintage or shabby chic ambience. Including floor-protecting plastic glides.

Material: Powder-coated aluminum. Easy to clean!

Chair stackable!

	Stack-able	WxDxH cm	Seat height cm	Weight kg	Color	Ref.	Pcs./pack	Pack €	Piece €
16					vintage grey	30003526	2	179,98	89,99
17 Chair	yes	55x51x89	45	2.8	vintage white	30003527	2	179,98	89,99
18					vintage blue	30003525	2	179,98	89,99

	Dimensions cm	Weight kg	Color	Ref.	Piece €
19	75x75x76 (LxWxH)	8.7	vintage grey	30003532	179,00
20 Table square			vintage white	30003533	179,00
21			vintage blue	30003531	179,00
22	75x120x76 (LxWxH)	11.5	vintage grey	30003529	229,00
23 Table rectangular			vintage white	30003530	229,00
24			vintage blue	30003528	229,00



+49 8272 807 447



service@em-group.com



www.em-group.com



2

Chair
COSIMO
84⁹⁹

> Table top LIFT see p. 321



Chair
VINCENT
79⁹⁹

3

- Lightweight
- Stackable



1



2



3



4

Chair COSIMO

With a linear shape, the weatherproof, padded outdoor chair COSIMO fits into any modern terrace ambience. The special advantage of this chair is the very comfortable upholstery made of hard-wearing and easy-care Textilene® material and Quick-Dry-Foam®. Up to five chairs are stackable.

Material: Aluminum in stainless steel look or anthracite powder coated. Cover: Plastic Textilene®

Weatherproof! Stackable! Very comfortable! Quick-Dry-Foam®! Easy to clean!



	WxDxH cm	Seat height cm	Armrest height cm	Weight kg	Color (frame)	Color (seat)	Ref.	Pcs./ pack	Pack €	Piece €
1	55x56x87	45	65	3.5	silver	anthracite	10080518	2	169,98	84,99
2					anthracite	anthracite	10080547	2	169,98	84,99

Chair VINCENT

Comfortable, stable and high-quality wickerwork chair made of aluminum. Up to five chairs are stackable for space-saving storage.

Material frame: Aluminum, brushed in stainless steel look or powder-coated.

Material armrest: Teak or polywood (new model).

Material seat: High-quality polyethylene wickerwork.

Stackable! UV-resistant and weatherproof!



	WxDxH cm	Seat height cm	Armrest height cm	Weight kg	Color (frame)	Color (seat)	Ref.	Pcs./ pack	Pack €	Piece €
3	54x52.5x86	44	67	3.5	silver	dark taupe	10094680	2	159,98	79,99
4					anthracite	brown	30041389	2	159,98	79,99

- Water-repellent
- UV-resistant
- Non-slip surface on the underside

Seat cushion
VINCENT

9⁹⁹

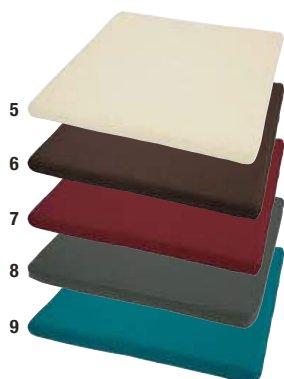

Seat cushion VINCENT

The cover can be easily separated from the foam filling by a zipper. Perfect hold - even without straps guarantees the non-slip underside made of PVC.

Cover: 100 % polyester. 30 °C washable. Filling: Polyester. Water-repellent and UV-resistant! Removable!

	LxWxH cm	Color	Ref.	Piece €
5	40x40x3	ecru	10082778	9,99
6		chocolate	10082780	9,99
7		bordeaux	10082775	9,99
8		anthracite	10082774	9,99
9		petrol	10080335	9,99



Chair
CHAPTER
64⁹⁹

Furniture outdoor

- Water-repellent
- UV-resistant

Seat cushion
CHAPTER

9⁹⁹



Seat cushion CHAPTER

Optimally suitable for chair CHAPTER, this water-repellent and lightfast seat cushion is also ideal for outdoor use. The hard-wearing cover has a special non-slip coating on the underside of the cushion which ensures that the cushion always stays in place.

Cover: 100 % polyester. Filling: Polyether foam. Water-repellent! Lightfast!

	WxDxH cm	Color	Ref.	Pcs./ pack	Pack €	Piece €
10	41x36.5x2.5	anthracite	10070669	4	39,96	9,99
11		petrol	10080349	4	39,96	9,99

- Stackable
- Weatherproof



Chair CHAPTER

Do you want a chair for your outdoor area that looks modern and straightforward and at the same time meets the highest functional demands? The weatherproof outdoor chair CHAPTER with its simplicity is ideal for any modern ambience. It is made of very stable, matt powder-coated aluminum with a material thickness of 1.2 mm. Available in classic, timeless and trendy colors. The chair also convinces with comfortable armrests with stacking protection. Up to five chairs can be stacked to save space.

Material: Aluminum, powder-coated. Weatherproof! Stackable! Stacking protection!



	WxDxH cm	Stack- able	Seat height cm	Armrest height cm	Weight kg	Color	Ref.	Pcs./ pack	Pack €	Piece €
12	55x57x86	yes	43	63	3.8	anthracite	10080717	4	259,96	64,99
13						taupe	10080718	4	259,96	64,99
14						marsala	10070570	4	259,96	64,99



- Ferrari Batyline®
- Durable and lightweight
- Foldable



Deck chair BELIZE

The deck chair BELIZE with cushion is adjustable in four positions and easy to fold and looks very inviting in every outdoor area. Its frame is made of sturdy, powder-coated aluminum. The colors petrol and taupe can be optimally combined with the frame color anthracite. The deck chair also fits perfectly with the chair series TAILOR. Dimensions folded: 62x12x128 cm.

Material: Aluminum, powder-coated. Fabric: Ferrari Batyline®. Foldable! Weatherproof! With cushion!

	WxDxH cm	Weight kg	Color	Ref.	Pcs./ pack	Pack €	Piece €
1	58x111x90	7	petrol	10097712	2	210,00	105,00
2			taupe	10097715	2	210,00	105,00



- Ferrari Batyline®
- Durable and lightweight
- 2 frame colors

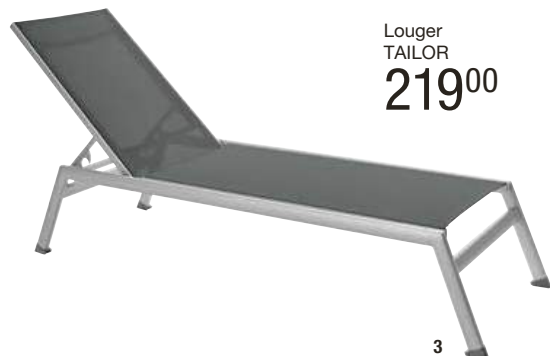

Lounger
TAILOR
219,00



Lounger TAILOR

High-quality loungers made of powder-coated aluminum. The durable fabric is high-quality Ferrari Batyline®, which is easy-care, weather and UV-resistant and quick-drying. With innovative glides, up to 5 loungers can easily be stacked without scratching. The backrest is adjustable in 4 different positions. Lying surface 193x52 cm.

Material: Aluminum, powder-coated. Fabric: Ferrari Batyline®. Stackable! UV-resistant! Weatherproof!

	LxWxH cm	Seat height cm	Weight kg	Color (frame)	Color (seat)	Ref.	Piece €
3	208x59x34	34	9	silver	anthracite	10095301	219,00
4				anthracite	petrol	10097701	219,00
5				anthracite	taupe	10097702	219,00



Chair TAILOR

TAILOR is not only visually appealing, it convinces above all by its quality. The UV-resistant frame is made of sturdy aluminum and is powder-coated. Durable and UV-resistant fabric. All chairs have a stacking protection at the bottom, which protects against scratches. Teak armrests at chairs with armrest.

Material: Aluminum, powder-coated. Fabric: Ferrari Batyline®.

Stackable! Stable! Weatherproof! Stacking protection!

	WxDxH cm	Seat height cm	Weight kg	Color (frame)	Color (seat)	Ref.	Pcs./ pack	Pack €	Piece €
6	56x58x84	45	4	silver	anthracite	10092532	2	189,98	94,99
7 Chair with armrest				petrol	10097699	2	189,98	94,99	
8				grey	taupe	10097700	2	189,98	94,99
9	48x57x84	45	3	silver	anthracite	10092461	2	159,98	79,99
10 Chair without armrest				petrol	10097697	2	159,98	79,99	
11				grey	taupe	10097698	2	159,98	79,99

- Ferrari Batyline®
- Durable and lightweight
- 2 frame colors

Chair
TAILOR, from
79⁹⁹



**Over 20,000 products
in our online shop!**

Order easy and comfortable online:
95 % in stock, fast delivery, always
new products and offers!

*Discover our
new products!*



*The complete range
at a glance!*

Get inspired online now!

**BEST
SELLER**

Seat cushion
VINCENT
9⁹⁹



Seat cushion VINCENT

The cover can be easily separated from the foam filling by a zipper. Perfect hold - even without straps guarantees the non-slip underside made of PVC.

Cover: 100 % polyester. 30 °C washable.

Filling: Polyester. Water-repellent and UV-resistant! Removable!

	LxWxH cm	Color	Ref.	Piece €
1	40x40x3	bordeaux	10082775	9,99
2		anthracite	10082774	9,99



Barstool
ARTLESS
69⁹⁹

Care spray for furniture series ARTLESS can be found at

→ www.em-group.com



Lightweight aluminum

Bar table
ARTLESS
179⁰⁰



Bench cushion
ARTLESS
19⁹⁹



Bench cushion ARTLESS

Suitable for bench ARTLESS. The cushion is fastened to the middle slat of the bench with 3 straps.

Cover: 100 % polyester. 30 °C washable.

Filling: Polyurethane foam. Water-repellent and UV-resistant! Removable!

	WxLxH cm	Color	Ref.	Piece €
3	144x34x3.5	blackberry	10089341	19,99
4		anthracite	10089340	19,99

Furniture series ARTLESS

An ingenious material combination: Bench, table, barstool, bar table and chair of this series are made of aluminum in stainless steel look with plastic slats - and therefore UV and weather-resistant. Thanks to a special coating, the plastic slats are particularly easy to clean and scratch-resistant. The bench offers space for three people and can be slid under the table on both sides. Up to five chairs are stackable - a real storage space advantage. Tables and bench are delivered disassembled - easy assembly!

Material: Aluminum in stainless steel look. Slats: Plastic. Easy to clean! UV-resistant! Suitable for outdoors! Chair stackable! 3-year availability guarantee!





3-seater bench
ARTLESS
139⁰⁰

- Imitation wood
- UV-resistant
- Chair stackable

Chair
ARTLESS
94⁹⁹

Table
ARTLESS, from
159⁰⁰



	Stack-able	Seat height cm	Dimensions cm	Weight kg	Ref.	Pcs./pack	Pack €	Piece €
5			72x72x110 (LxWxH)	11	10094884	1	179,00	179,00
6		76	34x34x76 (WxDxH)	3	10094885	2	139,98	69,99
7		45	144x34x45 (WxDxH)	8.5	10094882	1	139,00	139,00
8	yes	43.5	55x54x89 (WxDxH)	5	10094886	2	189,98	94,99

	Stack-able	Seat height cm	Dimensions cm	Weight kg	Ref.	Pcs./pack	Pack €	Piece €
9			72x80x75 (LxWxH)	8	10095276	1	159,00	159,00
10			72x120x75 (LxWxH)	12.5	10095275	1	189,00	189,00
11			72x160x75 (LxWxH)	16.5	10094883	1	219,00	219,00

Easy assembly, delivered disassembled, incl. mounting material for our table tops.

NEW



Armchair
ASOLA
279⁰⁰

> Side table GIMANI see p. 351

- Easy to clean
- UV and weather-resistant
- Incl. pillow



1



2

Armchair and sofa ASOLA



Stylish furniture with convincing design and comfort through cool material mix. The frame is made of powder-coated aluminium. Thus the outdoor lounge is highly scratch, impact and corrosion protected. Seat height without pillow: 35.0 cm.

Material frame: Powder-coated aluminum, braided with rope wickerwork.
Material pillow: Olefin fabric (100 % polypropylene).

	Dimensions cm	Weight kg	Ref.	Piece €
1 Armchair	68x80x76 (WxDxH)	9	30099898	279,00
2 2-seater sofa	147x76x80 (WxHxD)	19	30099897	479,00



Rope wickerwork



Bench
TOLMINA

199⁰⁰

Furniture outdoor

High-quality eucalyptus wood



The mark of responsible forestry

- Solid, multi-layered wood
- UV and weather-resistant
- Easy to clean



Furniture series TOLMINA

Solid wood outdoor furniture made of high-quality eucalyptus wood. The surface is well protected with a special varnish for all year outdoor use. Due to the matt finish in the color tobacco the surface looks very natural and of high quality. The panels of the bench are slightly inclined inwards, creating an ergonomic sitting feeling. Floor unevenness can be easily compensated by adjustable feet.

Material: FSC® certified solid eucalyptus wood, specially lacquered. Easy to clean! Suitable for outdoors!



	Dimensions cm	Weight kg	Ref.	Piece €
3 Table	180x65x72 (LxWxH)	26	30003356	399,00
4 Bench	160x33x44 (WxDxH)	16	30003354	199,00



High-quality eucalyptus wood

AVENTURO – combine individually



Serving trolley AVENTURO

Such a serving trolley as AVENTURO convinces in design and function! With its high-quality frame made of 1.2 mm thick, matt powder-coated aluminum and shelves made of robust plastic, it is extremely stable, UV and weather-resistant and extremely easy to clean. On its 2nd and 3rd floor, sturdy cross struts (included in the scope of delivery) can be inserted to safely transport bottles, glassware, crockery, cruet stands and much more. In addition, various GN containers made of different materials and a cutlery holder can also be transported with a perfect fit. This makes this serving trolley highly flexible and is the perfect everyday support for everyone. Frames and shelves can be individually combined in color with many of our existing chairs and tables. AVENTURO is therefore the best choice for your modern indoor and outdoor ambience.

Material: Matt powder-coated aluminum, shelves made of plastic in wood look, cutlery holder made of polypropylene.

Suitable for outdoors! 3-year availability guarantee!

	Dimensions cm	Color	Ref.	Piece/Set €
1 Frame	119x56x80 (WxDxH)	anthracite	10080377	99,99
2 Shelf	97.5x53x3 (WxDxH)	grey	10080378	49,99
	32.5x53x3 (WxDxH)	grey	10080410	29,99
4 Wheel set	8 (Ø)	silver	30043633	29,99

	LxWxD cm	Material	Color	Ref.	Piece/Set €
5	53x32.5x6.5	Melamine	white	10006315	29,99
6 GN container			black	10006324	29,99
7 GN 1/1		Plastic	transparent	30025740	14,99
8		Stainless steel 18/10	silver	10081630	14,99

Frame is delivered disassembled, incl. mounting material! Max. load per shelf: 40 kg.

1. Choose for the two top levels

> 1 shelf



> Or from these 5 parts



> More GN versions can be found in our online shop at www.em-group.com

- Individually combinable
- UV and weather-resistant

- GN containers available in 3 different materials

2. Add one shelf as floor

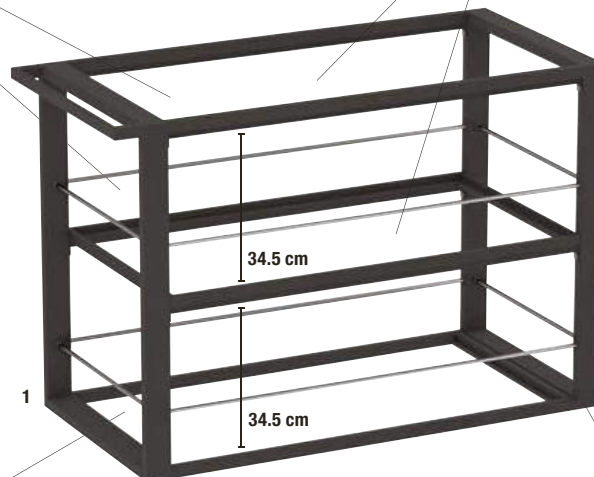

3. Mount the wheels



**BEST
SELLER**



Serving trolley
AVENTURO, from
279⁹⁵

Furniture outdoor

Cutlery holder
AVENTURO
39⁹⁹



Cutlery holder AVENTURO
Material: Polypropylene. GN 1/1.

	LxWxH cm	Ref.	Piece €
9	53x32.5x9	10080423	39,99

Combination examples:



Total price € 319,93



Total price € 304,93



Total price € 359,91



Serving trolley set AVENTURO

It's quick and easy with our complete serving trolley set. Select the complete set via a single item number and benefit from our attractive price offer compared to the purchase of the individual parts.

Consisting of:

- 1x frame
- 2x shelf (97.5x53.0x3.0 cm)
- 2x shelf (53.0x32.5x3.0 cm)
- 1x wheel set 4-piece
- 1x cutlery holder



10

	WxHxD cm	Ref.	Piece €
10	119x56x89	30022038	299,00

**BEST
SELLER**

Bar chair
METROPOLITAN
109⁰⁰

> Bar table METROPOLITAN see p. 366

Seat cushion
METROPOLITAN
9⁹⁹

- Water-repellent
- UV-resistant



1



2



3

4

5

6

7



Seat cushion METROPOLITAN

The cover can be easily removed from the foam filling by a zipper.

**Cover: 100 % polyester. 30 °C washable.
Filling: Polyether foam. Water-repellent!
UV-resistant!**

Bar chair METROPOLITAN

Made of high-quality brand wickerwork, they are particularly durable and UV-resistant. The frame is made of sturdy aluminum, aluminum caps on the feet protect the wickerwork.

**Material: Aluminum frame, wickerwork made of high-density polyethylene. Weatherproof!
UV-resistant! With stainless steel foot rail protector! 3-year availability guarantee!**



	WxDxH cm	Seat height cm	Weight kg	Color	Ref.	Pcs./pack	Pack €	Piece €
1	45x51x110	81	5	dark taupe	10094039	2	218,00	109,00
2				black	10099098	2	218,00	109,00

	WxLxH cm	Color	Ref.	Pcs./pack	Pack €	Piece €
3	42x43x3.5	ecru	10089294	2	19,98	9,99
4		chocolate	10089296	2	19,98	9,99
5		bordeaux	10089291	2	19,98	9,99
6		anthracite	10089290	2	19,98	9,99
7		petrol	10080348	2	19,98	9,99



High quality and durable Lightweight

- Lightweight
- Stackable



Chair METROPOLITAN

Made of high-quality brand wickerwork, they are particularly durable and UV-resistant. The frame is made of sturdy aluminum, aluminum caps on the feet protect the wickerwork.

Material: Frame aluminum, wickerwork made of high-density polyethylene. UV-resistant! Weatherproof! Stackable! 3-year availability guarantee!

	Stackable	LxWxH cm	Seat height cm	Armrest height cm	Weight kg	Color	Ref.	Pcs./pack	Pack €	Piece €
8 Chair without armrest	yes	48x56x90.5	46		4	dark taupe	30002387	2	139,98	69,99
9 Chair without armrest						black	30002378	2	139,98	69,99
10 Chair with armrest	yes	55x63x93.5	46	65	4.5	dark taupe	10094036	2	179,98	89,99
11 Chair with armrest						black	10094662	2	179,98	89,99

Find more products at www.em-group.com

+49 8272 807 447

service@em-group.com

www.em-group.com



> Bar chair METROPOLITAN see p. 364

■ Glass or high-pressure laminate table top sold separately



Bar table METROPOLITAN, from

211⁹⁹



Table top



1 - 3
Glass black

4 - 6
High-pressure laminate grey

Table frame



dark taupe

black

Table METROPOLITAN

All table frames are made of high-quality brand wickerwork and are particularly durable and UV-resistant. The frame is made of sturdy aluminum, aluminum caps on the feet protect the wickerwork. The table tops are optionally available in safety glass or high-pressure laminate.

Material: Aluminum frame, wickerwork made of high-density polyethylene. UV-resistant! Weatherproof! Bar table frame incl. foot rail protector made of aluminum in stainless steel look! 3-year availability guarantee!

	LxWxH cm	Weight kg	Color	Ref.	Piece €
1	79.5x71x0.5	7.5	black	10094436	66,99
2 Glass table top	121x79.5x0.5	12.5	black	10094438	92,99
3	69.5x61x0.5	5.5	black	10094442	52,99

	LxWxH cm	Weight kg	Color	Ref.	Piece €
4	79.5x71x0.5	4.8	grey	10089532	99,99
5 Compact table top	121x79.5x0.5	8	grey	10089531	139,00
6	69.5x61x0.5	3.5	grey	10089533	69,99
7	80x80x75	8.5	dark taupe	10099452	129,00
8			black	10099453	129,00
9	130x80x75	11	dark taupe	10099457	149,00
10			black	10099458	149,00
11	70x70x110	11	dark taupe	10099447	159,00
12			black	10099448	159,00

Easy assembly, delivered disassembled, incl. mounting material for our table tops.





Lounger
METROPOLITAN
299⁰⁰

- Water-repellent
- UV-resistant

Lounger pad
MELROSE/METROPOLITAN
64⁹⁹



- Height-adjustable backrest
- High-quality wheels
- Stackable



Lounger pad



MELROSE/METROPOLITAN

On the underside of the pad is a special non-slip coating made of PVC.

Cover: 100 % polyester. 30 °C washable. Filling: Polyurethane foam. Water-repellent and UV-resistant!

	WxLxH cm	Color	Ref.	Piece €
13		anthracite	10082767	64,99
14	196x60x5	blackberry	10082768	64,99
15		ecru	10082769	64,99

Lounger METROPOLITAN



The loungers are made of high-quality brand wickerwork and are very durable and UV-resistant. The frame is made of sturdy aluminum, aluminum caps on the feet protect the wickerwork. All loungers are stackable and equipped with 2 high-quality wheels. The backrest is adjustable in 4 different positions as well as flat adjustable. Ideal for outdoors.

Material: Frame aluminum, wickerwork made of high-density polyethylene. UV-resistant! Durable! Weatherproof! Stackable! With wheels! Aluminum caps on the feet! 3-year availability guarantee!

	LxWxH cm	Weight kg	Color	Ref.	Piece €
16	202x83.5x34	15	dark taupe	10094109	299,00
17			black	10094351	299,00



> Chair GIMANI see p. 351

For year-round use



The mark of responsible forestry

Lounger
SALMARA
479⁰⁰

- Backrest with 5 positions
- Combinable



Lounger SALMARA

High-quality, very comfortable, quick-drying lounger for year-round use in outdoor and spa areas. The backrest with stable stainless steel mechanism can be adjusted in 5 comfortable positions. With the large, rubberized wheels, it can also be moved quickly from A to B. Stainless steel covers with hard rubber coating - protects the floor and prevents noise.

Material: FSC® certified solid eucalyptus wood, specially lacquered. Material lying surface: Rope (98 % polypropylene + 2 % polyeste yarn). Delivered assembled! Foldable! With wheels! Backrest adjustable!

	LxWxH cm	Weight kg	Ref.	Piece €
1	194x61x32	18	30045433	479,00



Large, rubberized wheel



Rope wickerwork



- With or without armrest
- Stackable

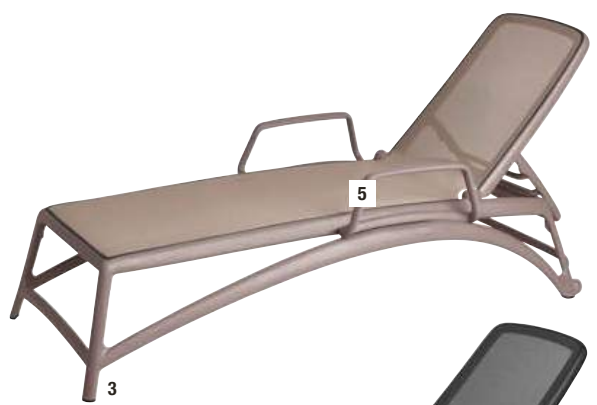

Side table
ATLANTICO
49⁹⁹

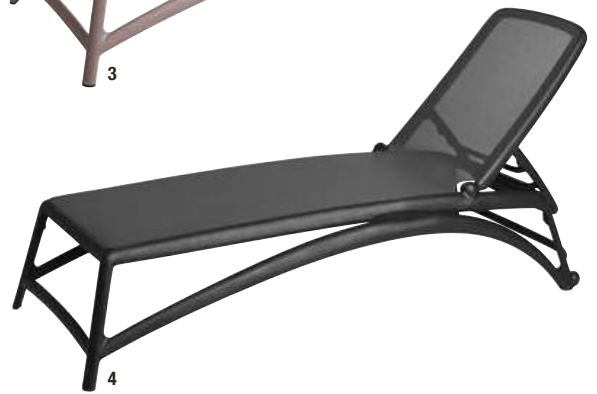

Lounger ATLANTICO

Perfect for your outdoor or spa area: Sun lounger with UV-resistant polypropylene fiberglass frame. With wheels and fully dyed cover made of breathable synthetic fabric. Four-way adjustable backrest. Armrests made of UV-resistant fiberglass polypropylene can be mounted in addition. Easy assembly of the armrests (screws included). Side table with non-slip feet caps and tray made of UV-resistant fiberglass polypropylene. The bottom of the side table can be removed by a clip system: This makes the table easy to clean and the bottom can also be used as a tray.

Material frame: Fiberglass polypropylene. Material cover: Synthetic fiber. With wheels! Stackable! Foldable! Combinable! Backrest adjustable!

	Stack-able	Dimensions cm	Weight kg	Color	Ref.	Piece €
2		204x70x35 (LxWxH)	16	white/taupe	30045450	249,00
3 Lounger	yes			taupe	30045451	249,00
4				anthracite	30045449	249,00



Adjustable backrest

	Stack-able	Dimensions cm	Weight kg	Color	Ref.	Piece €
5		49x20x5 (WxDxH)	1.2	white	30045457	19,99
6	yes			taupe	30045453	19,99
6				anthracite	30045456	19,99
7		29x37x39 (LxWxH)	2.5	white	30045458	49,99
8 Side table	yes			taupe	30045455	49,99
9				anthracite	30045454	49,99



Chair
MELROSE, from
64⁹⁹

> Table base ARGENTO see p. 335

- Stackable
- Easy to clean



Lounger
MELROSE
179⁰⁰

Furniture series MELROSE

The modern lounge series in wickerwork look is made of sturdy, fiberglass reinforced plastic. The lounge set is not only convincing due to its modern design, but also due to its longevity, UV-resistance and easy maintenance. Up to four chairs are stackable.

Material: Fiberglass reinforced plastic.

Stackable! UV-resistant! Durable! Weatherproof!



	Stackable	Dimensions cm	Seat height cm	Armrest height cm	Weight kg	Color	Ref.	Pcs./pack	Pack €	Piece €
1 Chair with armrest	yes	57x59x88 (WxDxH)	46.5	65	4.9	anthracite	10093865	2	159,98	79,99
2 Chair without armrest	yes	45x46x88 (WxDxH)	46.5		3.8	anthracite	10094223	2	129,98	64,99
3 Bar chair	yes	45x51x108 (WxDxH)	75		5	anthracite	10094493	4	271,96	67,99
4 Lounger	yes	189x79x43.5 (LxWxH)			11.5	anthracite	10093862	1	179,00	179,00
5 Lounge table		45x45x45 (LxWxH)			2.5	anthracite	10093877	1	29,99	29,99

The tables are delivered disassembled, easy assembly. Please fasten the legs with a rubber mallet.



Lounger pad
MELROSE
see p. 367 or at

www.em-group.com



Find more products at

www.em-group.com



> Illuminated flower pots at www.em-group.com

1-seater element
LOGGIA
129,00

Furniture outdoor

Absolutely weatherproof & flexible!

■ Individually usable



Row connector
4,98



Lounge series LOGGIA

Absolutely weatherproof and flexible! The padded lounge is made of aluminum and covered with a UV-resistant plastic fabric. Side table incl. adjusting screws to compensate for uneven floors. This lounge can be arranged as desired and linked by 2 row connectors. The side table is supplied with a glass table top in stone look, which is securely supported by transparent stoppers.

Material: Aluminum and plastic. Weatherproof! Easy to clean! Individually usable! UV-resistant!

	Dimensions cm	Seat height cm	Weight kg	Ref.	Piece €
6 1-seater element	59x77x82 (WxDxH)	39	5.6	10094718	129,00
7 Corner element	77x77x82 (WxDxH)	39	8.2	10094720	169,00
8 Lounge table	45x70x40 (LxWxH)		7.2	10094722	94,99
	WxDxH cm	Ref.	Set €		
9 Row connector pack of 2	6.5x4x4	10099679	4,98		



Chair
RABEA

39⁹⁹



Chair with armrest
NIARA

79⁹⁹

- Lightweight and robust
- Stackable
- UV-resistant



- Lightweight and hard-wearing
- Stackable
- UV-resistant



Chair RABEA

Elegant, simple, fiberglass reinforced plastic chair in modern colors. The sturdy chair is stackable up to 8 pieces. Suitable for indoors and outdoors.

Material: Fiberglass reinforced polypropylene.
Stackable! Weatherproof! UV-resistant!



	Stack-able	WxDxH cm	Seat height cm	Weight kg	Color	Ref.	Pcs./pack	Pack €	Piece €
1	yes	45x52x80.5	45.5	3.1	light grey	10093886	4	159,96	39,99
2	yes	45x52x80.5	45.5	3.1	anthracite	10093885	4	159,96	39,99

Chair NIARA

The stackable and weatherproof outdoor chair NIARA is a very attractive and interesting eye-catcher: Its modern shape promises high seating comfort. Made of UV-resistant, high-quality polypropylene with fiberglass reinforcement and non-slip chair legs, makes this chair a first-class choice. Stackable up to 5 pieces.

Material: Polypropylene with fiberglass reinforcement.
Stackable! UV-resistant! Fully dyed!



	Stack-able	WxDxH cm	Seat height cm	Armrest height cm	Weight kg	Color	Ref.	Pcs./pack	Pack €	Piece €
3						anthracite	10070512	4	319,96	79,99
4	yes	60.5x58.5x80	46.5	67.5	4	marsala	10070511	4	319,96	79,99
5						taupe	10070513	4	319,96	79,99

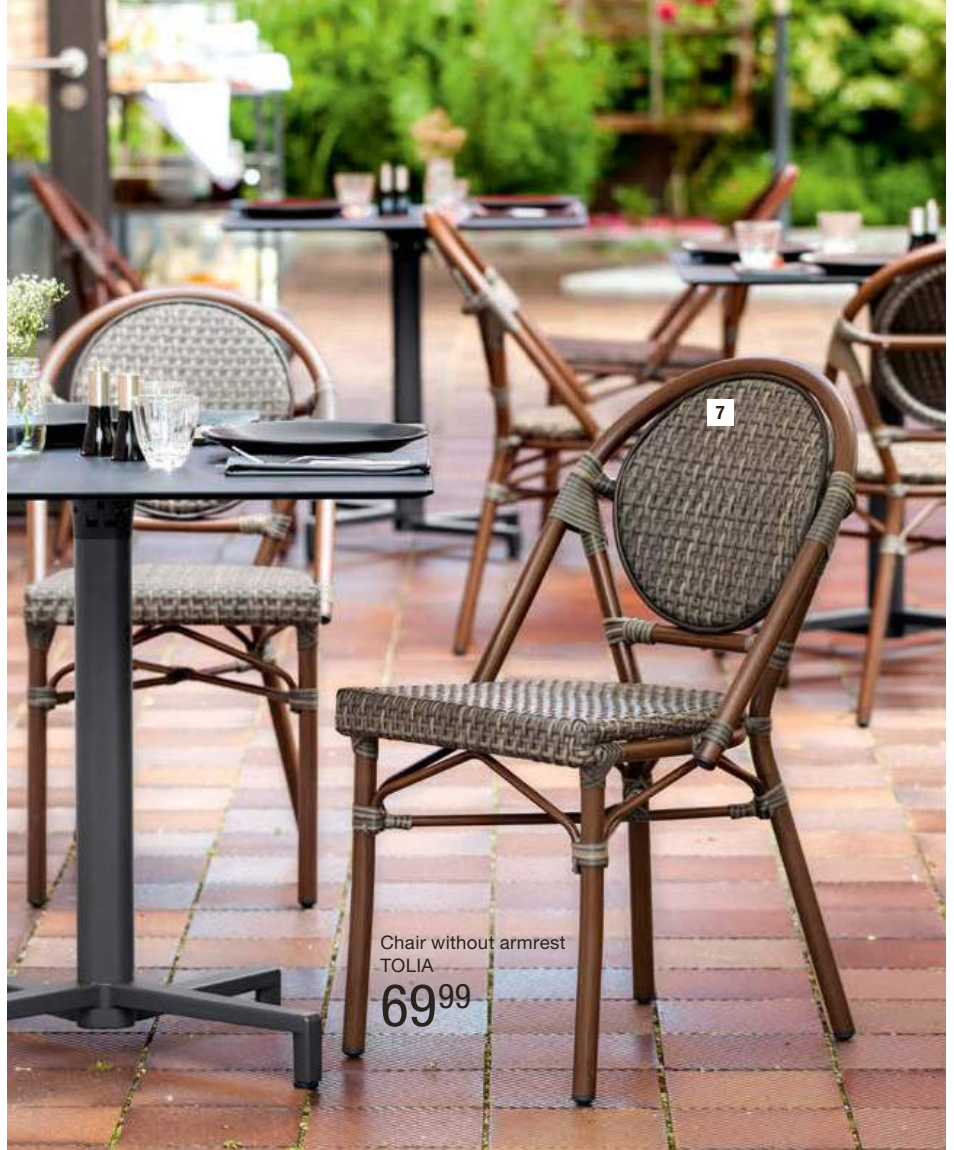
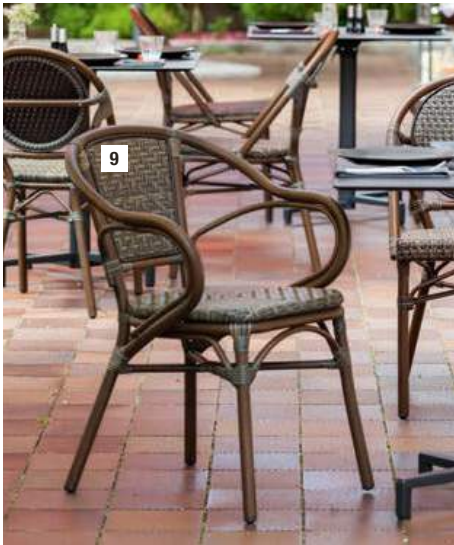

- Aluminum in wood look
- Weatherproof
- Chair stackable

Chair with armrest
TOLIA

74⁹⁹



Furniture series TOLIA

High-quality furniture series with frame made of powder-coated aluminum in bamboo look - weatherproof, UV-resistant and therefore ideal for outdoor use. Seat and backrest made of high-density polyethylene in braided look. Table top made of HPL laminate. Tables incl. plastic glides on the underside.

Material frame: Aluminum, powder-coated. Seat made of polyethylene. Table top made of HPL laminate. Chair stackable! Weatherproof! UV-resistant!



	Stackable	Dimensions cm	Seat height cm	Armrest height cm	Weight kg	Color (frame)	Color (seat)	Ref.	Pcs./pack	Pack €	Piece €
6	Chair without armrest	46x55x87.5 (WxDxH)	46		3.8	light brown	black	30040080	2	139,98	69,99
7	Chair without armrest					dark brown	tobacco	10080351	2	139,98	69,99
8	Chair with armrest	58x58x81.5 (WxDxH)	46	66	4.2	light brown	black	30040083	2	149,98	74,99
9	Chair with armrest					dark brown	tobacco	10080359	2	149,98	74,99
10	Table	80x74 (ØxH)			10	dark brown		30038903	1	129,00	129,00
11	Table					light brown		30038904	1	129,00	129,00

Chair
RIMALIA, from
74⁹⁹



> Table base REGULO see p. 326

- Stable aluminum
- Weatherproof
- Stackable

NEW

5, 6



Synthetic wickerwork
anthracite

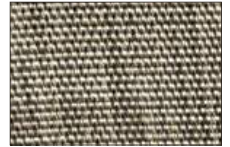

Plastic fabric
grey mottled



Chair series RIMALIA

A perfect combination of modern design and high-quality workmanship! The frame of these chairs looks like precious wood, but is made of powder-coated aluminum. This makes the chairs not only lightweight, but also robust and weatherproof - making them ideal for outdoor catering. The seat and backrest are made of weatherproof plastic fabric. The slightly wider seat of the lounge enables ergonomic sitting. Practical: Due to their low weight, all models are stackable and can be stored in a space-saving manner. Plastic glides on the legs protect the floor.

Material: Aluminum, powder-coated. Plastic. Weatherproof! Stackable! 3-year availability guarantee!



	Stack-able	WxDxH cm	Seat height cm	Armrest height cm	Weight kg	Color	Ref.	Pcs./pack	Pack €	Piece €
1	yes	58x56.5x82	46	66	3.5	anthracite/brown	30003038	2	159,98	79,99
2						Chair with armrest	grey mottled/brown	30003039	2	159,98
3	yes	46x53x87.5	46		3	anthracite/brown	30003036	2	149,98	74,99
4						Chair without armrest	grey mottled/brown	30003037	2	149,98
5	yes	36x36x76	76		2.5	anthracite/brown	30078708	2	139,98	69,99
6						NEW Barstool	grey mottled/brown	30078707	2	139,98



Chair
ASTORIA

74⁹⁹

> Table base REGULO see p. 327

Furniture outdoor

- Stable aluminum
- Weatherproof
- Stackable

NEW

8, 9



7



8



9

Chair ASTORIA

Robust outdoor chair made of an attractive material of aluminium and wickerwork. Incl. plastic glides. Delivered assembled.

Material frame: Powder-coated aluminum. Material seat: Plastic wickerwork. Easy to clean! Stackable! Weatherproof!

	WxDxH cm	Stack-able	Seat height cm	Weight kg	Color	Ref.	Pcs./pack	Pack €	Piece €
7					blue/white	30046949	2	149,98	74,99
8	46x53x87.5	yes	46	3	NEW grey/white	30068750	2	149,98	74,99
9					NEW red/white	30068759	2	149,98	74,99



Side view of the chair

Bench with backrest
EXPOSE
229⁰⁰



- Foldable
- Solid wood



Bench
EXPOSE
139⁰⁰



Bench pad
EXPOSE
29⁹⁹

- Water-repellent
- UV-resistant



Furniture series EXPOSE

This high-quality, modern table-bench set meets all requirements. It is quick and easy to assemble and disassemble due to the easy handling of the folding mechanism and stackable. The sturdy, galvanized and anthracite powder-coated steel frame is as weatherproof and water-repellent as the table and bench slats made of sturdy ash with a thickness of 3.0 cm.

Material: Frame: Steel, powder-coated, slats: Ash tree, pressure-impregnated. Weatherproof! High-quality workmanship! Space-saving! Suitable for outdoors! Stacking protection!



	Dimensions cm	Weight kg	Ref.	Piece €
1 Table	180x60x76.5 (LxWxH)	33	10070791	229,00
2 Bench	180x30x48 (WxDxH)	16.5	10075002	139,00
3 Bench with backrest	180x46x81 (WxDxH)	24.5	30023915	229,00

Bench pad EXPOSE

This comfortable and perfectly fitting all-weather pad for the bench EXPOSE is ideal for outdoors! The foam dries very fast thanks to its special Quick-Dry-Foam® technology. Cover removable.

Cover: 100 % polypropylene. 30 °C washable. Weatherproof! Water-repellent!

	LxWxH cm	Color	Ref.	Piece €
4	180x30x3.5	black mottled	10089408	29,99
5		natural mottled	10089407	29,99



Table
BAVARIA, from
119,00

6

9

Furniture outdoor

Chair
BAVARIA

59,99

- Foldable
- Solid wood



6



7



8



9

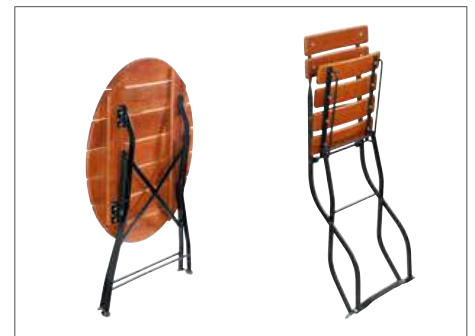

Foldable

Seat cushion
BAVARIA

9,99

- Water-repellent
- UV-resistant



10

11

Beer garden series BAVARIA

The wood elements made of ash are pressure-impregnated, double thick film varnished and with continuous screws. This makes the series weatherproof and extremely robust. The frame made of galvanized and powder-coated steel is equipped with plastic glides that protect the floor.

Material: Frame: Steel, galvanized and powder-coated. Slats: Ash tree, pressure-impregnated. Foldable! Easy to clean! Floor protecting table and chair glides! Double weatherproof thick film varnish! Continuous screws! 3-year availability guarantee!



	Dimensions cm	Seat height cm	Weight kg	Ref.	Pcs./pack	Pack €	Piece €
6 Chair	41.5x49x88.5 (WxDxH)	47		10089903	2	119,98	59,99
7 Table round	80x74 (ØxH)		15	10089907	1	129,00	129,00
8 Table square	80x80x74 (LxWxH)		17	10089906	1	119,00	119,00
9 Table rectangular	120x80x74 (LxWxH)		20	10089908	1	149,00	149,00

Seat cushion BAVARIA

Suitable for chairs of the beer garden series BAVARIA. The cushions have a zipper, so the covers can be easily removed. Attachment with 2 fabric straps.

Cover: 100 % polyester. 30 °C washable. Water-repellent and UV-resistant! Removable!

	LxWxH cm	Color	Ref.	Pcs./pack	Pack €	Piece €
10	41x41x4	dark green	10089248	2	19,98	9,99
11	41x41x4	anthracite	10089242	2	19,98	9,99



Table
ALICANTE
149⁰⁰

6

4

Bench pad
ALICANTE
28⁹⁹



Bench pad ALICANTE

Suitable for our teak bench ALICANTE. Thanks to a zipper, the pad cover can easily be removed from the 5 cm high foam filling. Suitable for outdoor use.

Cover: 100 % polyester. 30 °C washable.

Filling: Polyether foam.

	LxWxH cm	Color	Ref.	Piece €
1	138x50x5	ecru	10089238	28,99
2		anthracite	30046125	28,99

Care kit
TEAK
39⁹⁹



3

Care kit TEAK

If you want to keep the original color of your teak furniture permanently, you should treat it with our teak care kit once a year. Set consisting of: 1 l teak cleaner, 1 l protector and 1 brush, 1 sponge and gloves. Sufficient for about 12 chairs.

	Ref.	Set €
3	10090379	39,99

- Teakwood solid
- Chair and table foldable



Chair
ALICANTE
54⁹⁹

4



5



6



Teakwood series ALICANTE

We offer high quality chairs, benches and the matching table made of plantation teakwood. Teak is considered to be particularly weatherproof, but after a certain time it forms a silvery shiny patina. This is completely natural and does not represent a deficiency. If you want to keep the original color of your teak furniture permanently, it is best to treat it once a year with our teak care kit.

Weatherproof! Chair and table foldable!

	Dimensions cm	Seat height cm	Weight kg	Ref.	Pcs./pack	Pack €	Piece €
4 Chair (foldable)	47x60x87.5 (WxDxH)	45	5.2	10093823	2	109,98	54,99
5 Bench	148x66x93 (WxDxH)	45	23.9	10094107	1	249,00	249,00
6 Table square	80x80x75 (LxWxH)		20	10094106	1	149,00	149,00

Easy assembly, delivered disassembled.

- Teakwood solid
- Lightweight and robust
- Chair stackable

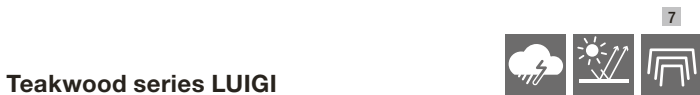

Teakwood series LUIGI

Lightweight and very robust furniture made of solid, raw teakwood and aluminium. The chairs are stackable up to six pieces. Please order our care kit (Ref. 10090379).

Lightweight! Weatherproof! Easy to clean! Aluminum pipe Ø 2.5 cm (at the chair)! Chair stackable!

	Stackable	Dimensions cm	Seat height cm	Armrest height cm	Weight kg	Ref.	Pcs./pack	Pack €	Piece €
7 Chair	yes	50.5x53x78.5 (WxDxH)	44.5	62.5	3.6	10091110	4	219,96	54,99
8 Bar chair		42x43.5x98.5 (WxDxH)	81		3.6	10091084	2	129,98	64,99
9 Bar table		60x112 (ØxH)			10.9	10090587	1	79,99	79,99

Easy assembly, delivered disassembled.

Teak table top LUIGI, from

69,99

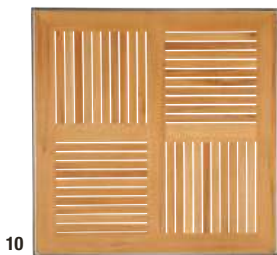

10

11

Teak table top LUIGI

The weatherproof table tops made of solid teakwood are available with or without aluminum frame. They fit perfectly with our table bases. Mounting material is included in the table base.

Material: Solid teakwood. Weatherproof! Easy to clean!

	LxWxH cm	Weight kg	Ref.	Piece €
10 With aluminum frame	60x60x2	3.3	10095063	74,99
	70x70x2	4.2	10095060	79,99
	80x80x2	6	10095070	89,99
11 Without aluminum frame	60x60x2	4	10095061	69,99
	70x70x2	4.7	10095059	74,99
	80x80x2	6.3	10095062	84,99

The table top is simply screwed to the table base.



Furniture outdoor

Foldable

Table base TAIPA

69,99



Space-saving storage

12

Table base TAIPA

Strong aluminum and additional weights give the table base the necessary stability. The staggered shape of the base cross and the folding table cross allow for space-saving combination of several tables. Suitable for all table tops from our range.

Material: Aluminum, brushed. Incl. adjustment screws for compensation of uneven floors. Suitable for indoor and outdoors! Space-saving! Foldable! Weatherproof! 3-year availability guarantee!

	WxLxH cm	Weight kg	Max. rec. table top size cm	Ref.	Piece €
12	66x66x72	7	80 (Ø), 70x70 (WxL)	10095048	69,99

Easy assembly, delivered disassembled.



Chair
MALVENA
39⁹⁹



Table square
MALVENA
89⁹⁹



1



3



5

- Lightweight
- Chair stackable
- Weatherproof



2



4



6

Furniture series MALVENA

The weatherproof chairs and tables are made of high-quality aluminum and powder-coated in various colors. Up to six chairs can be stacked on top of each other to save space. The chair frames with a diameter of 2.5 cm and a material thickness of 2.0 mm are easy to clean, scratch-resistant and of course resistant to any weather!

Material: Aluminum, powder-coated.
Weatherproof! Chair stackable! Easy to clean!
3-year availability guarantee!



	Stack-able	Dimensions cm	Seat height cm	Armrest height cm	Weight kg	Color	Ref.	Pcs./pack	Pack €	Piece €
1	yes	52x59x72 (WxDxH)	43.5	58.5	3	anthracite	10008116	4	159,96	39,99
2						olive	10008465	4	159,96	39,99
3		70x70x72 (LxWxH)			7.4	anthracite	10008118	1	89,99	89,99
4						olive	10008469	1	89,99	89,99
5		60x72 (ØxH)			6.2	anthracite	10008117	1	79,99	79,99
6						olive	10008467	1	79,99	79,99



Chair
DANILO
44⁹⁹

The clever bistro seating

- Lightweight
- Stackable
- Weatherproof



Seat cushion FIRENZE and LINEARES see p. 385 or at

www.em-group.com



7



8

Chair DANILO

This chair with comfortable armrests is almost a classic. Its frame is made of powder-coated aluminum in various colors, with a diameter of 2.5 cm and a material thickness of 2.0 mm. The high-quality plastic wickerwork tone-on-tone has an integrated wire core, which increases the longevity and stability of the chair significantly. The chairs are easy to clean and stackable up to six pieces.

Material: Aluminum, powder-coated. Plastic wickerwork. Weatherproof! Stackable! Easy to clean! Suitable for outdoors!



	WxDxH cm	Seat height cm	Armrest height cm	Weight kg	Color	Ref.	Pcs./pack	Pack €	Piece €
7	52x59.5x71	43.5	60	3.4	anthracite	10008119	4	179,96	44,99
8					olive	10008471	4	179,96	44,99



2

Bistro chair
AMIGO

29⁹⁹

- Lightweight
- Easy to clean



4

Aluminum wickerwork
chair COLUMBIA

39⁹⁹

> Seat cushion LINEARES see p. 385

- Frame made of aluminum
- Chairs stackable



1



2



3



4



Bistro chair AMIGO

AMIGO offers comfortable seating, attractive look and stability at a very attractive price! The frame with a thickness of 1.2 mm made of galvanized, powder-coated steel pipe makes it stable and lightweight. Seat and backrest are made of plastic wickerwork. Matching seat cushion FIRENZE can be found at our online shop.

Material: Frame powder-coated steel with plastic wickerwork. Weatherproof! UV-resistant! Stackable!

	WxDxH cm	Stackable	Seat height cm	Armrest height cm	Weight kg	Color	Ref.	Pcs./pack	Pack €	Piece €
1	53x55.5x75	yes	43.5	58.5	5	beige	10091852	4	119,96	29,99
2	53x55.5x75	yes	43.5	58.5	5	grey	10091855	4	119,96	29,99



Aluminum wickerwork chair COLUMBIA

Cool, comfortable and sensational in price: Polished aluminum chairs! The light and yet robust material is suitable for any kind of furnishing and can be used both inside and outside. Your guests will be happy to sit here! Frame with Ø 2.5 cm and a material thickness of 2 mm.

Weatherproof! Stackable!

	WxDxH cm	Stackable	Seat height cm	Armrest height cm	Weight kg	Color	Ref.	Pcs./pack	Pack €	Piece €
3	52x59.5x71	yes	43	60	3.5	honey	10091426	4	159,96	39,99
4	52x59.5x71	yes	43	60	3.5	grey	10092323	4	159,96	39,99



Aluminum chair
LIMONA, from
34⁹⁹

Furniture outdoor

Cool & comfortable at a reasonable price



5



6



7

- Lightweight and robust
- Chair stackable



8



9



10

Bar table
LIMONA
64⁹⁹

5, 6, 9



Aluminum furniture LIMONA

Cool, comfortable and at a reasonable price: Polished aluminum chairs and tables! The lightweight and durable material fits every furnishing and can be used indoors and outdoors. Frame with Ø 2.5 cm and a material thickness of 2 mm. Matching seat cushion LINEARES can be found at our on-line shop.

Material: Aluminum anodized. Weatherproof!
Chair and aluminum table square stackable!

	Stackable	Dimensions cm	Seat height cm	Armrest height cm	Weight kg	Ref.	Pcs./pack	Pack €	Piece €
5 Aluminum chair without armrest	yes	50x55x78.5 (WxDxH)	43.5		3.2	10091429	4	139,96	34,99
6 Aluminum chair with armrest	yes	53x57x73 (WxDxH)	43.5	60	2.9	10092672	4	159,96	39,99
7 Aluminum table square	yes	70x70 (WxH)			10.7	10091207	1	74,99	74,99
8 Aluminum table round		60x70 (ØxH)			6.9	10091208	1	54,99	54,99
9 Aluminum table square	yes	80x80x70 (LxWxH)			12.1	10091210	1	79,99	79,99
10 Bar table		60x110 (ØxH)			7.6	10091398	1	64,99	64,99

Easy assembly, delivered disassembled.



- Waterproof
- Easy to clean
- UV-resistant
- Durable and robust
- Also suitable for indoor use

Carpet
DANEL, from
29⁹⁹



Carpet DANEL

Whether indoors or outdoors: These carpets made of pure polypropylene are particularly robust, UV and weather-resistant. Convince yourself of the design and quality - the durable carpets will also inspire you! Easy to clean.

Material: 100 % polypropylene. 30 °C gentle wash, do not chlorinate.

	LxW cm	Color	Ref.	Piece €
1	72x52	anthracite	30052284	29,99
2		taupe	30052283	29,99
3		turquoise	30052282	29,99
1	92x72	anthracite	30052278	49,99
2		taupe	30052277	49,99
3		turquoise	30052276	49,99



	LxW cm	Color	Ref.	Piece €
1	132x72	anthracite	30052290	79,99
2		taupe	30052289	79,99
3		turquoise	30052288	79,99
1	200x140	anthracite	30052293	249,00
2		taupe	30052292	249,00
3		turquoise	30052291	249,00
1	240x170	anthracite	30052281	329,00
2		taupe	30052280	329,00
3		turquoise	30052279	329,00
1	300x200	anthracite	30052287	459,00
2		taupe	30052286	459,00
3		turquoise	30052285	459,00

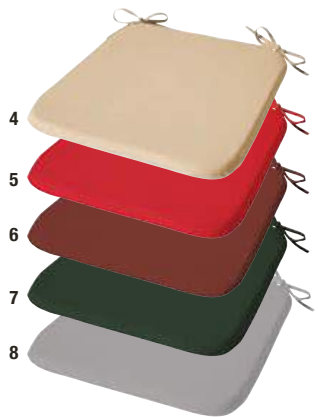

Seat cushion LINEARES

Available in various colors. Thanks to a zipper, the cushion cover can easily be removed from the foam filling. Dimensions cushion with backrest in total: 41.5x80x3 cm. Suitable for outdoors.

Material cover: 100 % polyester. 30 °C washable. Material filling: Polyurethane. Removable!

	Without backrest	With backrest
WxLxH cm	42x42x3	41x38.5x3
beige	4 10089212	9 10089226
light red	5 10089218	10 10089231
bordeaux	6 10089213	11 10089227
dark green	7 10089214	12 10089228
stone grey	8 10089222	13 10089236
Pcs./pack	2	4
Pack €	14,98	41,96
Piece €	7,49	10,49



Furniture outdoor

Seat cushion
COLORI
6,99



Seat cushion
KLIA
6,99



Seat cushion
BONO
4,99



Find more products at
www.em-group.com

Seat cushion COLORI

Cover made of 100 % polyester, easy-care and stain-resistant. Attachment with two elastic rubber bands.

Material: 100 % polyester.

WxLxH cm	
14 dark blue	40x37.5x4 10020473
15 green	10024800
16 beige	10020321
17 brown	10025666
18 anthracite	10020314
19 champagne	10025686
20 light red	10025664
Piece €	6,99

Seat cushion KLIA

The modern classic. Square, without fastening straps with nine topstitchings, the seat cushion fits both outdoors and indoors.

Material: 100 % polyester.

WxLxH cm	
21 dark blue	38x38x3 10000002
22 green	10000006
23 beige	10029027
24 brown	10026165
25 anthracite	10025951
26 champagne	10020237
27 red	10020235
Piece €	6,99

Seat cushion BONO

You can get our basic model in an inexpensive pack of 12 in 5 classic garden colors: Red, green, brown, graphite and anthracite. With rubber bands, insensitive to stains. Suitable for indoor and outdoor use.

Material: 100 % polyester.

WxLxH cm	
28 red	40x40x3 10020291
29 green	10020279
30 brown	10020200
31 graphite	10020198
32 anthracite	30014256
Pcs./pack	12
Pack €	59,88
Piece €	4,99



Sunshade
SIROC

129⁰⁰



Easy opening by crank



Sturdy aluminum struts

- UV-resistant
- Water-repellent
- Incl. protective cover



Sunshade SIROC

In the compact size of only 2x2 m, this high-quality sunshade with protective cover at an attractive price is the best choice if you have only little space, for example on the sidewalk! The small sunshade offers great advantages: The sturdy frame made of powder-coated aluminum, a stem with Ø 48 mm and 8 struts with WxD 13x22 mm can be easily opened with a crank. The highly water-repellent fabric with 250 g/m² made of 100 % polyester is UV-resistant 50+ and lightfast. Keep closed in strong winds.

Material: 100 % polyester. Easy opening by crank! Incl. protective cover! Sturdy struts! UV-protection 50+, lightfast, water-repellent!

	Shape	LxWxH cm	Weight kg	Color	Ref.	Piece €
1				burgundy	10082876	129,00
2	square	200x200x227	4.5	creamy-white	10082874	129,00
3				anthracite	10082875	129,00

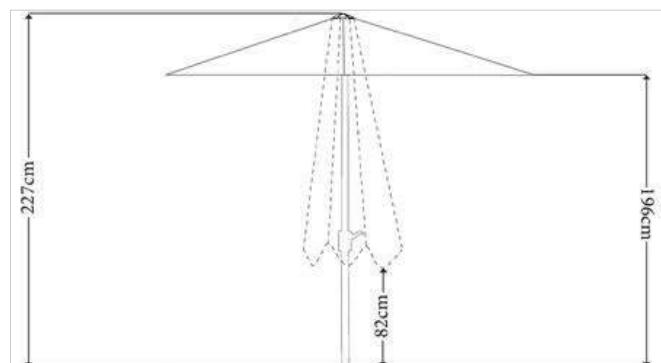



Easy opening by crank



Sturdy aluminum struts

- UV-resistant
- Incl. protective cover



Sunshade CIELO

First-class sunshade at an attractive price! UV-resistant sunshade with protective cover with frame made of sturdy, powder-coated aluminum. The stem with Ø 48 mm and eight reinforced struts with WxD 13x22 mm brace the screen for the tough gastronomy routine. The cover with valance consists of 250 g/m² polyester, is water-repellent, lightfast and UV-resistant! Keep closed in strong winds.

Material: 100 % polyester. Easy opening by crank! Incl. protective cover! Sturdy struts! UV-protection 50+, lightfast, water-repellent!

	Shape	LxWxH cm	Weight kg	Color	Ref.	Piece €
4	square	300x300x260	5.5	ecru	10089387	159,00
5				red	10089391	159,00
6				brown	10089386	159,00
7				grey	10089388	159,00

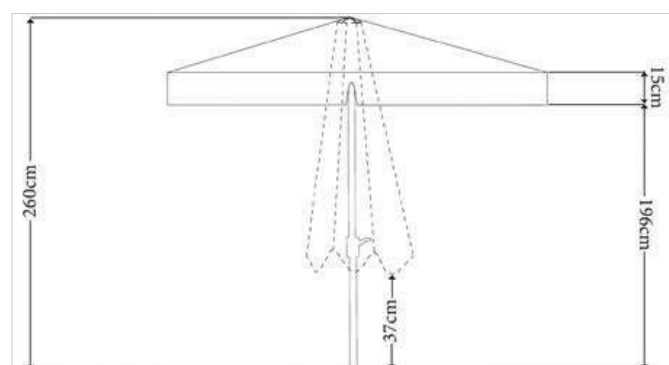

2

Hanging sunshade
BREVA

339⁰⁰



Sturdy aluminum struts



Easy adjustment of the screen angle possible



Cast iron swivel with foot pedal

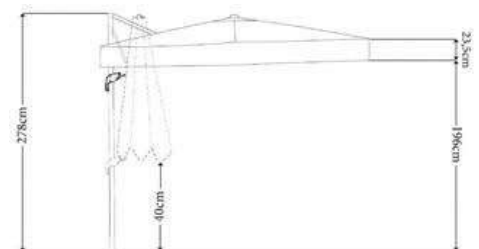

Hanging sunshade BREVA

Where there is much sun, shadow is desired. A first-class and high-quality shade dispenser is the stable hanging sunshade with a frame made of powder-coated aluminum. The fabric is UV-resistant and lightfast. The water-repellent, tiltable roof surface can be turned 360° with a foot pedal at the end of the stem. A simple opening of the sunshade is guaranteed by a crank. Keep the sunshade closed in strong winds. Including protective cover and stable plate base. The fixing is made by inserting 40x40 cm to 50x50 cm paving slabs (not included in the scope of delivery).

Material stem: Powder-coated aluminum!

Material fabric: 100 % polyester.

Dimensions of the struts: WxD 14x24 mm! Delivery incl. cover!

Stem 7x5 cm with material thickness of 2 mm! UV-protection 50+!

	Shape	LxWxH cm	Weight kg	Color	Ref.	Piece €
1	square	295x295x270	23.2	ecru	10093845	339,00
2	square	295x295x270	23.2	grey	10093844	339,00

Sunshade will be delivered mounted, base must be assembled.

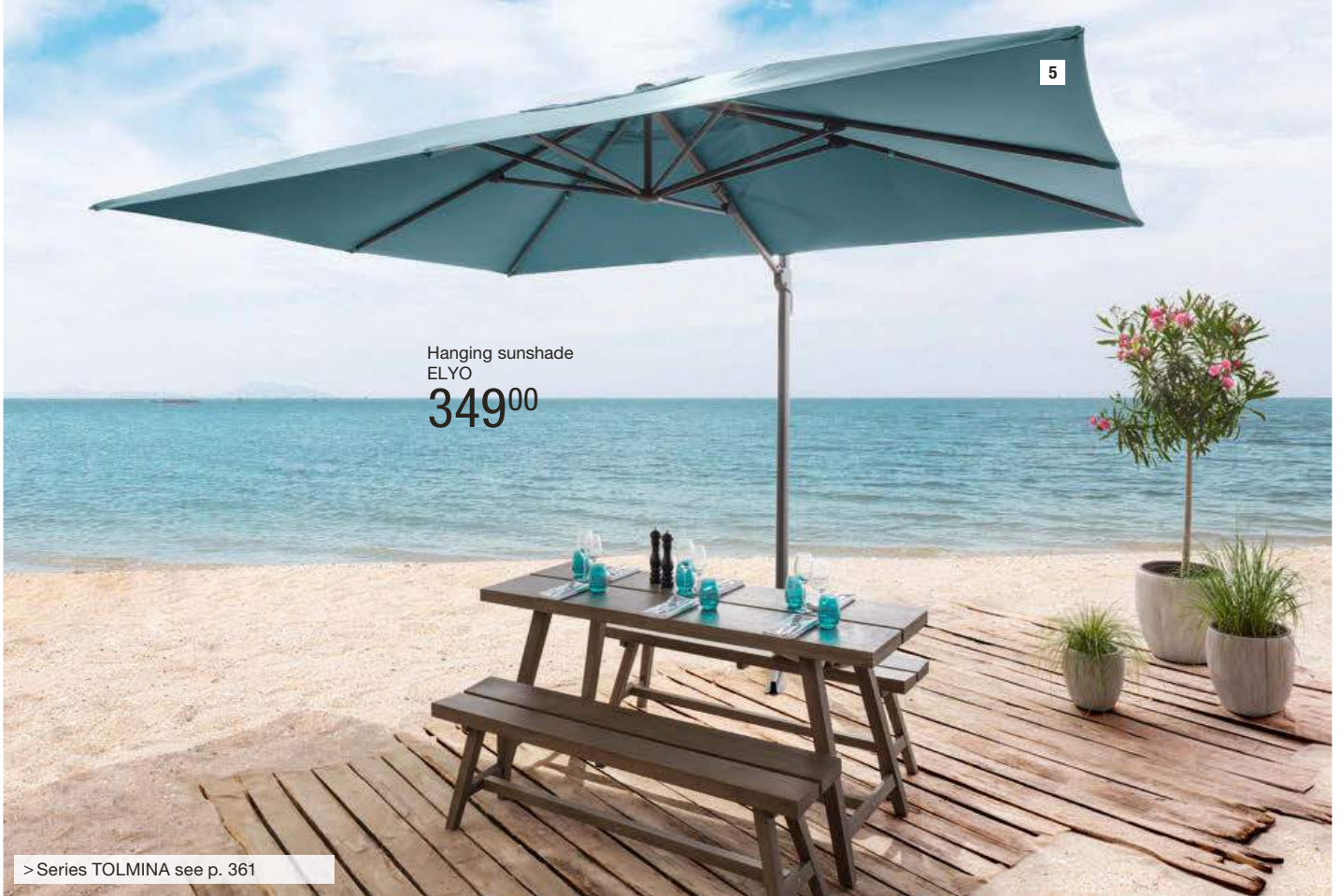

Hanging sunshade
ELYO
349⁰⁰

> Series TOLMINA see p. 361

For terrace or garden

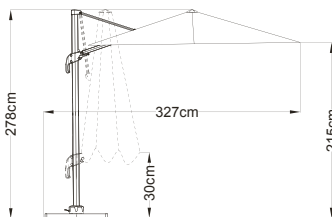

Hanging sunshade ELYO

Hanging sunshade with span range of 3x4 m for a large space of shade. Easy opening and closing by crank. 360° rotatable and 45° swiveling: Like this, your guests always have a place in the shade! Including protection cover and sunshade base. The attachment is made by inserting 40x40 cm to 50x50 cm large paving slabs (not included in the scope of delivery).

Material stem: Powder-coated aluminum. Material fabric: 100 % polyester, 250 g/m², UV-protection 50+. Lightweight and UV-resistant! Water-repellent!



Sturdy aluminum struts



Easy adjustment of the screen angle possible



Cast iron swivel with foot pedal

	Shape	LxWxH cm	Weight kg	Color	Ref.	Piece €
3	rectangular	300x400x275	29	anthracite	30026515	349,00
4				ecru	30026516	349,00
5				turquoise	30026517	349,00

Sunshade will be delivered mounted, base must be assembled.

Professional sunshade
ESPARTO

329⁰⁰



> Chair COSIMO see p. 354

Protective cover

49⁹⁹

■ UV-resistant



Protective cover

Suitable for professional sunshade ESPARTO. Cover with reinforcement strut and zipper, including rod.

Material: 100 % polyester. Waterproof! UV-resistant! Easy covering!

	LxW cm	Color	Ref.	Piece €
1	350x45	grey	10094227	49,99



■ Stem: Wooden look

■ Stem: Anthracite

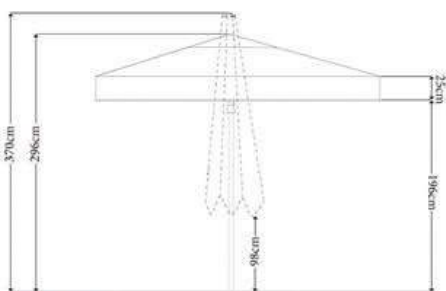

Professional sunshade ESPARTO

Professional large sunshade with extremely sturdy aluminum frame. The frame is powder-coated. The stem with Ø 60 mm and 8 reinforced struts (18x28 mm) give the sunshade the necessary stability. The UV-resistant, lightfast and extremely water-repellent cover with valance made of 230 g/m² polyester provides ideal protection against heat and UV rays. The integrated sliding system is supported by a spring inside the stem. This guarantees effortless opening and closing above the tables. Plastic covers at the end of the struts protect the lining. When opening and closing the large sunshade, watch out for objects and people. Please order at the same time: Plate base for stem Ø 60 mm.

Material: 100 % polyester.

High-quality lining! Reinforced struts! Plastic covers at the end of the struts! UV-protection 50+, lightfast, extremely water-repellent!



Effortless, spring supported sliding system



Reinforced struts



2 stem colors available

	LxWxH cm	Weight kg	Color	Color	Ref.	Piece €
2	350x350x370	21	Frame wooden look	ecru	10093995	329,00
3				grey	10093998	329,00
4			Frame anthracite	ecru	10008105	329,00
5				grey	10008107	329,00
6				burgundy	10008108	329,00

Double sunshade
LEVANTO
499⁰⁰



Your advantage
with LEVANTO

Rotatable and swiveling double sunshade: A large space of shade can be created with only a few sunshades.

Flexible shade

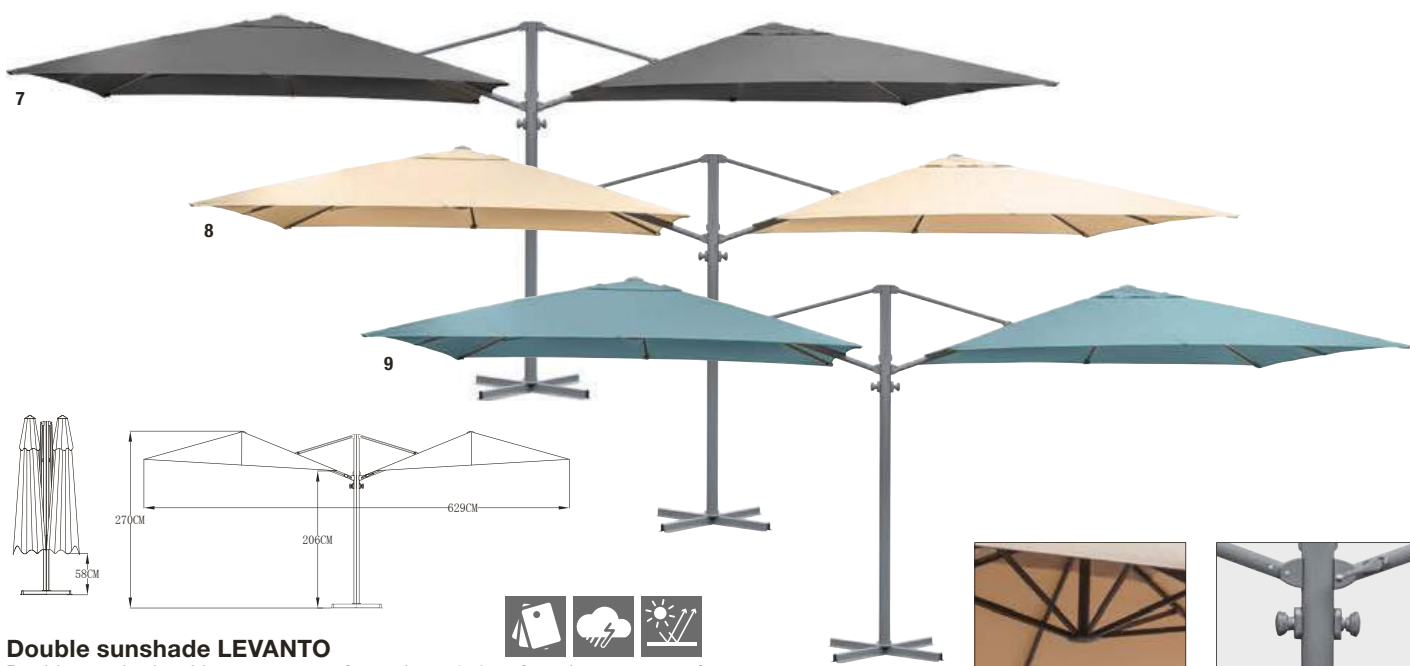

Double sunshade LEVANTO

Double sunshade with span range of two times 3x3 m for a large space of shade. Easy opening and closing by crank. 360° rotatable and 45° swiveling: Like this, your guests always have a place in the shade! Including protection cover and plate sunshade base. The attachment is made by inserting 40x40 cm to 50x50 cm large paving slabs (not included). Rotatable and space-saving.

Material stem: Powder-coated aluminum. Material fabric: 100 % polyester, 250 g/m², UV-protection 50+. Lightfast and UV-resistant! Water-repellent!

Sturdy aluminum struts

Easy opening and closing by crank

	LxWxH cm	Weight kg	Color	Ref.	Piece €
7			anthracite	30026512	499,00
8	300x300x270	45	ecru	30026513	499,00
9			turquoise	30026514	499,00



LED sunshade lighting
77⁹⁹

LED sunshade lighting

This light can be easily and quickly installed with the supplied mounting material to every sunshade. The two LED strips with extra bright light never lets your guests sit in the dark. The outdoor suitable supply cable has a length of 15 m and can easily be removed to protect the connections against moisture due to heavy rain. The LED strips as well as the on/off switch are fastened with velcro straps and do not interfere with the closing or opening of the sunshades. Connected load 230 V. Supplied with LEDs of energy efficiency class A.



	1
LxWxH cm	35.5x1.7x2
Connected load	8.4 W / 230 V
Color	silver/transparent
Ref.	10094609
Set €	77,99

Plate sunshade base
44⁹⁹



Plate sunshade base DETROIT

Made of galvanized, powder-coated steel. Suitable for sunshades with a stem Ø of max. 60 mm. The fixing is made by inserting 50x50 cm large paving slabs (not included in the scope of delivery).

Weatherproof! Stable!

	LxWxH cm	Weight kg	Ref.	Piece €
2	101x101x55.5	6	10070533	44,99

Easy assembly, delivered disassembled.

Granite sunshade base
64⁹⁹

■ With handle



Granite sunshade base

Sunshade base made of granite. With an pull-out handle and two wheels, the sunshade base can be easily transported. With adapter for stems up to Ø 58 mm. Suitable for sunshades up to Ø 3 m and 3x3 m.

Weatherproof! With handle! Rollable!

	WxH cm	Weight kg	Ref.	Piece €
5	52x6	40	10093497	64,99

Easy assembly, delivered disassembled.

Sunshade base FARGO, from
52⁹⁹

■ With handle



Sunshade base FARGO

Made of robust and weatherproof polymer concrete. The sunshade bases are equipped with handles, the angular also with wheels. Includes adapter for stems up to Ø 58 mm. Suitable for sunshades up to Ø 3 m and 3x3 m.

Weatherproof! With handles! Rollable!

	Shape	Dimensions cm	Weight kg	Ref.	Piece €
3	round	55x9 (ØxH)	40 kg	10094706	52,99
4	square	55x55x8 (LxWxH)	50 kg	10097703	62,99

Easy assembly, delivered disassembled.

Ground stem
49⁹⁹



Ground stem

Made of galvanized steel. Only the upper part (51 cm) is inserted into the lower, concreted part of the ground stem (40 cm) to install a sunshade. Thus, the ground stem protrudes 32 cm from the ground and stems up to Ø 60 mm can be inserted. If no sunshades are needed, the upper part is removed and the hole is closed with a closure cover. The required concrete foundation for the ground stem must be at least 50x50x50 cm and guarantees a safe position of the sunshade.

Weatherproof! Incl. cover lid! Stainless!

	ØxH cm	Ref.w	Piece €
6	6x72	10094347	49,99



Wire rope and accessories

4 mm thick wire ropes with 2 mm PVC covering and pressed loops at the ends. The galvanized connecting piece allows you to connect several ropes together. Enter your personal code in the brass combination lock.

	Dimensions cm	Ref.	Piece €	
7	300x0.6 (WxØ)	10090416	9,99	
	600x0.6 (WxØ)	10090417	11,99	
	900x0.6 (WxØ)	10090418	14,99	
8	Quick-release fastener/connecting piece	2.5x4.8x0.5 (WxHxØ)	10090419	1,99
9	Combination lock	3.1x1.5x6.5 (WxDxH)	10090420	8,99



Control via Bluetooth

- Free VEGA smartphone app
- Remote control of the radiant heater with the smartphone
- Bluetooth system with 20 m range



The infrared radiant heaters SAHARA, TARIA, PATAGONIA and SONORIA are equipped with Bluetooth so you can control the radiant heaters with your smartphone. Practical: The Bluetooth system allows you to operate several radiant heaters at the same time, turn them and also play music on certain models. The necessary password-protected smartphone app can be downloaded for free from the AppStore or GooglePlayStore under the name "Vega Heater Control".



Infrared radiant heater
SONORIA
379⁰⁰

Sit outside in cold temperatures

- Timer function
- 6 heating levels
- Adjustable via smartphone or remote control

Infrared radiant heater
SAHARA, from
259⁰⁰



10

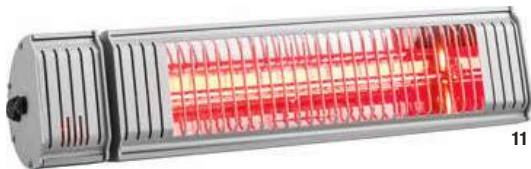

11



- 2 loudspeakers
- Atmospheric backlight
- Adjustable via smartphone or remote control
- 6 heating levels



12



Infrared radiant heater SAHARA and TARIA

- Power of 1500 W or 2000 W
- Adjustable via smartphone or remote control
- Remote control: Six heating levels selectable
- Via app: Steplessly adjustable from 0 to 100 % and up to 100 infrared radiators can be controlled simultaneously or independently of each other
- With timer function, heat-up time 10 seconds
- Incl. mounting material, wall and ceiling mounting possible
- Infrared tube: Gold tube Ultra Low Glare
- Heating area: Outdoor 6-12 m², indoor up to 25 m²
- Range remote control/Bluetooth: 6/20 m
- System requirements app: Android from version 4.3, iOS Apple from version 7

Material: Aluminum housing with protective grid. 2 years warranty. Suitable for indoors and protected outdoor areas!

	10 SAHARA	11 TARIA
WxHxD cm	55.6x13x10.8	55.6x13x10.8
Connected load	1500 W / 230 V	2000 W / 230 V
Lifespan of the tube	3000 h	3000 h
Cable length max.	1.9 m	1.9 m
Protection class	IP 65	IP 65
Weight kg	2.5	2.5
Ref.	30003489	30003487
Piece €	259,00	289,00

Infrared radiant heater SONORIA with music

- Incl. 2 loudspeakers for streaming music from smartphone
- With 4 LED strips for music-sensitive backlight
- Adjustable via smartphone or remote control
- Remote control: Six heating levels selectable
- Via app: Steplessly adjustable from 0 to 100 % and up to 100 infrared radiators can be controlled simultaneously or independently of each other
- With timer function, heat-up time 10 seconds
- Incl. mounting material, wall and ceiling mounting possible
- Infrared tube: Gold tube Ultra Low Glare
- Heating area: Outdoor 6-12 m², indoor up to 25 m²
- Range remote control/Bluetooth: 6/20 m
- System requirements app: Android from version 4.3, iOS Apple from version 7

Material: Aluminum housing with protective grid. 2 years warranty. Suitable for indoors and protected outdoor areas!

	12
WxHxD cm	74x13x10.8
Connected load	2000 W / 230 V
Lifespan of the tube	3000 h
Cable length max.	1.9 m
Protection class	IP 65
Weight kg	3.9
Ref.	30003491
Piece €	379,00

Create your separation system in 3 steps!



Outdoor separation system CAYA

You want to separate your outdoor area from the street or from other places? This is easily achieved with this easy-care, high-quality, robust and height-adjustable separation system. It is versatile and offers first-class wind, noise and dust protection. The easy construction works by feet, with or without anchoring in the ground. Individual shapes with adjustable connector elements, different sizes and wall elements that can be labelled with chalk markers offer a lot of creative freedom. Delivery within 5 weeks ex works.

Material walls: Powder-coated aluminum and safety glass; Material feet: Galvanized steel; Material connector elements: Powder-coated aluminum.

1. Choose a separation wall

2 colors and 3 sizes are available.

- Weatherproof
- UV-resistant
- Individually combinable



The exclusive something

Customize

- with your favorite motif
- with your individual text
- in your favorite color

More information can be found at our online shop

www.em-group.com

We are happy to assist

+49 8272 807 447

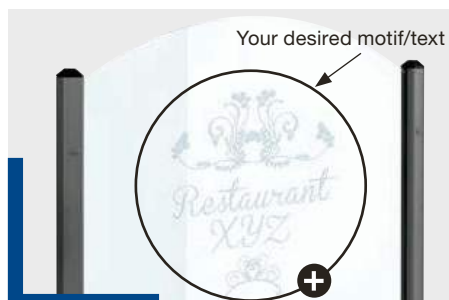

	WxH cm	Weight kg	Color	Ref.	Piece €
1	69x160	13	white	10094887	279,00
			anthracite	10094888	279,00
3	102.5x160	18	white	10094889	329,00
			anthracite	10093460	329,00
5	200x160	38	white	10093461	499,00
			anthracite	10093462	499,00



Separation wall
CAYA, from

279⁰⁰

2. Choose the matching ground element, depending on the nature of your ground

3. Choose the matching connector element for your system

2 colors are available.



7
Ground element for straight ground



8
Ground element for uneven ground



13

Connector element straight



14

Connector element straight



15

Connector element 90° fixed



16

Connector element 90° fixed



9
Ground fixing



10
Wall mount



11

Stabilization aid



12

Stabilization aid



Connector element adjustable



17



18

	Dimensions cm	Weight kg	Color	Ref.	Piece €
7 Ground element for straight ground	59x4.5 (WxH)	1.8	anthracite	10093675	39,99
8 Ground element for uneven ground	59x4.5 (WxH)	2.2	anthracite	10093676	39,99
9 Ground fixing	13x13x30 (WxDxH)	0.3	anthracite	10093677	29,99
10 Wall mount	5x5x7.5 (WxDxH)	0.3	black	10093673	24,99
11 Stabilization aid	45x15x63 (WxDxH)	2.5	white	10099583	89,99
			anthracite	10093674	89,99

	WxH cm	Weight kg	Color	Ref.	Piece €
13 Connector element straight	10x5	0.2	white	10099580	24,99
14 Connector element straight	10x5	0.2	anthracite	10093463	24,99
15 Connector element 90° fixed	10x5	0.2	white	10099582	24,99
			anthracite	10093672	24,99
17 Connector element adjustable	6x5	0.3	white	10099581	29,99
			anthracite	10093464	29,99

Easy assembly, delivered disassembled.



Barrier post and tape
BADARDO
82⁹⁹



Barrier post and tape BADARDO

High-quality barrier post made of stainless steel. The barrier tape is integrated into the column and has a practical roll-up mechanism. The columns can be combined with each other as desired via the 3 different hanging positions for the tape. The tape length is 2 m.

Material barrier tape: 100 % polyester.
Suitable for protected outdoor areas.

	ØxH cm	Weight kg	Color	Ref.	Piece €
1	37x96	9.6	red/silver	10092397	82,99
2			black/silver	10092396	82,99

Easy assembly, delivered disassembled.

Show your guests the right way!



Wall bracket RENGO

Available with or without barrier tape. Our wall bracket with barrier tape allows blocking without barrier posts! The tape is extendable up to 2 m and has a practical roll-up mechanism. Matching our barrier posts with tape. Mounting material is included.

Material barrier tape: 100 % polyester. Wall bracket: Stainless steel with plastic. Suitable for protected outdoor areas.

	Dimensions cm	Color	Ref.	Piece €
3 With barrier tape	6.5x12 (ØxH)	black	10093480	25,99
4		red	10093481	25,99
5 Without barrier tape	3x9.5x1.5 (LxWxH)	black	10093483	2,99

Easy assembly, mounting material is included.



Privacy screen AMELITA and METROPOLITAN can be found at

www.em-group.com



Barrier cord
VESARA
25⁹⁹

Barrier cord VESARA

Barrier cords made of durable nylon with snap hooks and caps made of solid stainless steel.

Material: Cord inside 100 % cotton, wrapped with yarn made of 100 % polyester.

Suitable for protected outdoor areas.

	LxØ cm	Weight kg	Color	Ref.	Pcs./ pack	Pack €	Piece €
6	153x3.2	0.8	gold	10090892	2	51,98	25,99
7 With gold snap hooks (brass)			red	10092185	2	51,98	25,99
8			black	10092369	2	51,98	25,99
9 With silver snap hooks (chrome)	153x3.2	0.8	red	10090893	2	51,98	25,99
10			black	10092368	2	51,98	25,99



Separation systems

Barrier post
NOHO
64⁹⁹

■ Stainless steel



11

Barrier post NOHO

The practical and flexible people guidance system made of stainless steel guides your guests indoors and outdoors in the right direction! The privacy screen is easily attached at the top and bottom.

Material: Stainless steel.

	ØxH cm	Weight kg	Ref.	Piece €
11	31x95	8	10092500	64,99

Easy assembly, delivered disassembled.

Wall bracket
ENIRO
9⁹⁹



14

15

Wall bracket ENIRO

Made of stainless steel. For attaching barrier cords. Incl. dowels and crews.

Suitable for protected outdoor areas.

	LxW cm	Color	Ref.	Piece €
14	5x3.5	silver	10092370	9,99
15		gold	10092371	9,99

Barrier post
ESANTO
49⁹⁹



12

13

Barrier post ESANTO

Barrier post made of stainless steel. Delivery without barrier cord - please order at the same time!

Suitable for protected outdoor areas.

	ØxH cm	Weight kg	Color	Ref.	Pcs./ pack	Pack €	Piece €
12	31x95	8	gold	10090890	2	99,98	49,99
13			black	10075003	2	99,98	49,99

Easy assembly, delivered disassembled.



14



15



Illuminated bar
AMPELIO, from
849⁰⁰

- Easy to clean
- Combinable



1



2



3

Ice bar
AMPELIO
399⁰⁰

Illuminated bar AMPELIO

Made of one piece. Temperature resistant from -60 °C to +80 °C. Suitable for indoors and outdoors all through the year. Delivery is without bulbs. Suitable for all energy saving lamps and and LED lamps of energy efficiency class A++ to A. 2 years warranty.

Material: Polyethylene. UV-resistant! Waterproof! Weatherproof!

	1 Straight	2 Round	3 Ice bar
WxHxD cm	90x110x80	173x110x75	94x86x48
Connected load	230 V	230 V	230 V
Bulb	25 W	25 W	25 W
Socket	E27	E27	E27
Weight kg	27	45	18
Color	white translucent	white translucent	white translucent
Cable length max.	3 m	3 m	3 m
Ref.	10082727	10082729	30002497
Piece €	999,00	849,00	399,00



Product info

- 2 years warranty
- Suitable for all energy saving lamps and LED lamps of energy efficiency class A++ to A
- Suitable for indoors and outdoors all through the year due to the temperature resistance of -60 °C to +80 °C
- Easy to clean

Standing ashtray
APOLLO
79⁹⁹



4

Standing ashtray APOLLO

With sand screen and waste bin. The delivery includes sand (1 kg)! The waste bin holds 40 l. The compact design ensures a safe stand.

Material: Steel sheet, lacquered.
Suitable for protected outdoor areas!

	ØxH cm	Weight kg	Ref.	Piece €
4	31x80	7.5	10053032	79,99



More ashtrays
can be found online at

www.em-group.com



Standing ashtray DORSALE

Plain and inconspicuous standing ashtray made of galvanized, powder-coated steel. For emptying, the insert can be removed from the top. Suitable for outdoor use, with closable lid and vandal-proof mounting. Capacity approx. 2.5 l, available in anthracite and copper, incl. mounting material and key.

Material: Steel, galvanized. Weatherproof!

	WxHxD cm	Color	Ref.	Piece €
5 Standing ashtray	17.5x106x12	anthracite	30054351	149,00
		copper	30054350	149,00
6 Wall ashtray	17.5x34x12	anthracite	30054352	89,99
		copper	30054353	89,99



Standing ashtray
KIPSO
64⁹⁹



7

Standing ashtray KIPSO

Standing ashtray with waste bin and removable sand screen. The waste bin holds 15 l.

Material: Steel sheet, lacquered.
Suitable for protected outdoor areas!

	ØxH cm	Weight kg	Ref.	Piece €
7	26x82	4	10053030	64,99



Standing ashtray
PLATINIUM
31⁹⁹



8

Standing ashtray PLATINIUM

With waste bin and removable ashtray. The waste bin holds 14 l.

Material: Steel.
Suitable for protected outdoor areas!

	ØxH cm	Weight kg	Ref.	Piece €
8	24x58.5	1.6	10059586	31,99



Ashtray
TOLEDO
4⁹⁹

■ Shock and break-proof



10

11

Ashtray TOLEDO

Particularly robust and break-proof. Thus extremely durable and ideally suited for everyday use in the catering industry.

Material: Melamine. Dishwasher safe!

	ØxH cm	Color	Ref.	Pcs./pack	Pack €	Piece €
10	14.5x6	white	30043022	6	29,94	4,99
11		black	30043021	6	29,94	4,99



Wind ashtray
GLASGOW
4⁹⁹



12

Wind ashtray GLASGOW

Material: Chrome-nickel stainless steel 18/8. Weatherproof!

	ØxH cm	Ref.	Pcs./pack	Pack €	Piece €
12	11x6	10070359	1	4,99	4,99



Standing ashtray
KOPA
339⁰⁰



9

Standing ashtray KOPA

With rain cover. Grey side walls made of aluminum. Easy and quick emptying by triangular key. Delivery includes key, but no mounting material. With waste bin. Vandal-proof 4-point fixing. Capacity: 30 l, ashtray: 5 l.

Material: Steel, galvanized. Side walls made of aluminium. Weatherproof!

	WxHxD cm	Weight kg	Ref.	Piece €
9	30x96x25	17.9	10053093	339,00



Wall ashtray
BASIC
89⁹⁹



13

Wall ashtray BASIC

With rain cover. Grey side walls made of aluminum. Easy and quick emptying by triangular key. A vandal-proof 4-point fixing is possible. Capacity: 2 l. Delivery includes key, but no mounting material.

Material: Steel, powder-coated. Weatherproof!

	WxHxD cm	Ref.	Piece €
13	23x28.2x6	10053092	89,99



BEST CHOICE

COFFEE

DESSERT

BREAKFAST

Menu

FOOD

AND

DRINKS

BOARDS

Your offer perfectly presented

Streetboard
LISTEO, from
99⁹⁹

- Foldable
- Easy to clean



Wall board
LISTEO, from
59⁹⁹

- Can be used horizontally and vertically



Streetboard and wall board LISTEO

Streetboard and boards with all-round frame made of solid beech wood in walnut stained and lacquered, with rounded edge. The streetboard is foldable and can be labeled on both sides and has very robust and durable hinges. The wall board can be hung vertically or horizontally. The matching hooks are included in delivery and can be attached to the wall with nails or screws. Delivered assembled.

Material: Beech wood. Foldable!

		WxH cm	WxH cm (labeling area)	Weight kg	Color	Ref.	Piece €
1	Streetboard	55x81.5	47x66	9.1	dark brown	30040413	99,99
2		68x115	60x101	16.8	dark brown	30040416	139,00
3	Wall board	56x100	48x92	6.9	dark brown	30040539	59,99
4		56x120	48x112	8.1	dark brown	30040541	69,99
5		56x150	48x142	9.9	dark brown	30040537	84,99



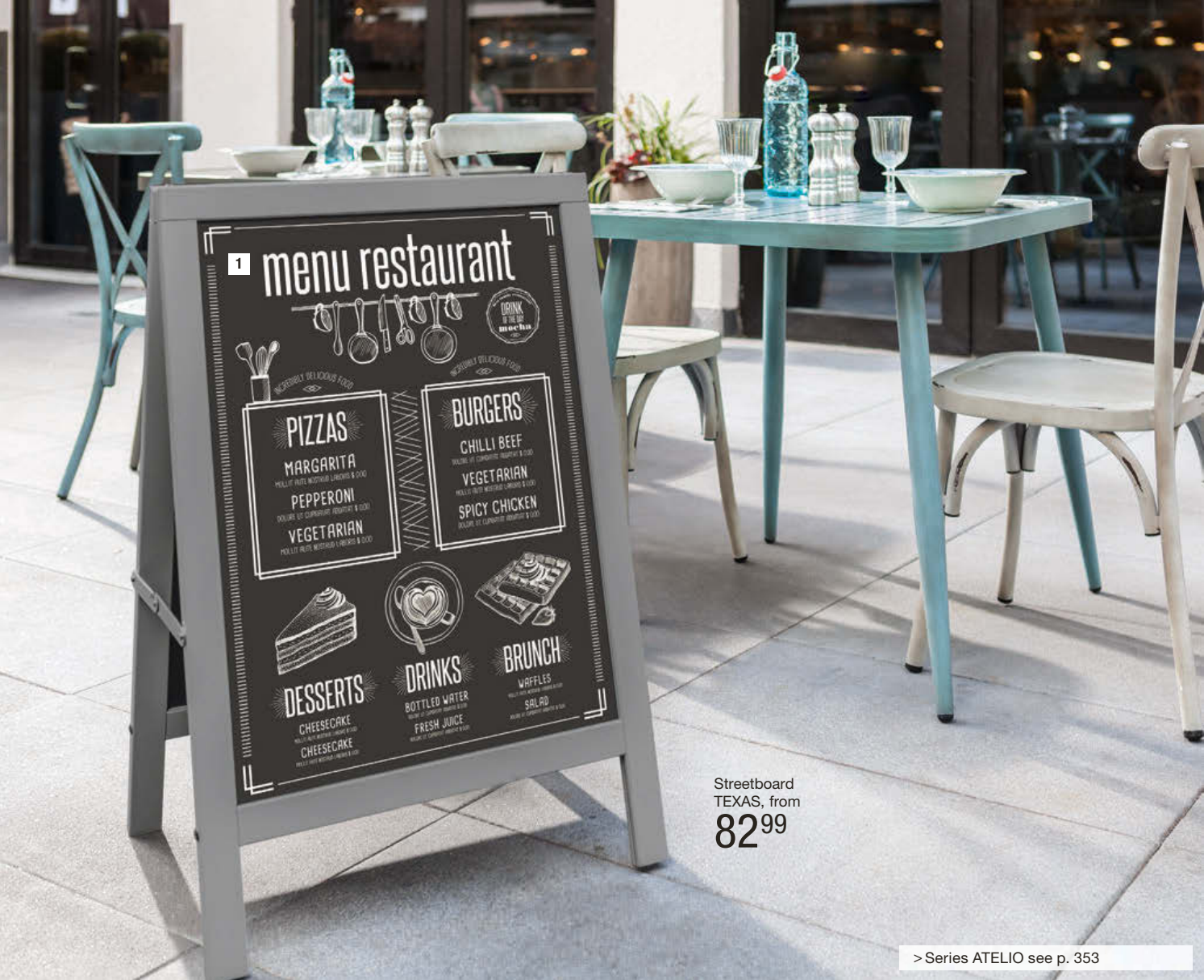

Streetboard
TEXAS, from
82,99

> Series ATELIO see p. 353

- Foldable
- Easy to clean



Streetboard TEXAS

Foldable, made of plastic with solid wood frame. Choose between boards that can be labeled on both sides or boards with fold-out feet.

For indoors and protected outdoor areas!

	WxH cm	WxH cm (labeling area)	Weight kg	Color	Ref.	Piece €
1	54x85	46x64	3.2	walnut	10089504	99,99
				grey	10089498	99,99
2				black	30026785	99,99

	WxH cm	WxH cm (labeling area)	Weight kg	Color	Ref.	Piece €
3	69.5x133	60.5x91	5.3	walnut	10089503	149,00
				grey	10089497	149,00
				black	30026786	149,00
	56x133	48x91	2.8	walnut	10089496	82,99
				grey	10089490	82,99
4				black	30026784	82,99





Streetboard ECO

These foldable plastic boards in good quality and at a reasonable price are ideal for indoor and outdoor use! Can be labelled on both sides.

Suitable for indoors and outdoors!

	WxH cm	WxH cm (labeling area)	Weight kg	Color	Ref.	Piece €
5				grey	10094482	54,99
6	61x101	52x80	3.8	red	10079081	54,99
7				brown	30045217	69,99



Chalk marker from

1,99



Chalk marker

Suitable for all smooth surfaces such as VEGA blackboards, glass, mirrors and much more. Easy to remove with a damp cloth. Available in three different widths.

Width	2 mm	6 mm	15 mm
8 white	10079275	10079018	10079019
9 red	10079277	10079022	10079023
Piece €	1,99	2,59	4,09

- With handle
- Foot foldable
- Easy to clean

Streetboard MANAO

99,00



Streetboard MANAO

Put your current offers in the limelight! This can be achieved through our streetboard MANAO. The stable blackboard with practical handle is made of 3 mm thick plastic. Its foldable foot ensures a secure stand at all times. The streetboard is inscribable with our chalk markers and can be easily cleaned with a damp cloth. With plastic glides.

Suitable for indoors and protected outdoor areas!

	WxH cm	Weight kg	Color	Ref.	Piece €
10	60x100	4.2	black	10089601	99,00





Menu display stand
CORTEO, from
229⁰⁰

1

- Illuminated
- Lockable

Menu display board
CORTEO
249⁰⁰



3



2



Lockable



Easy opening and closing

Menu display stand and board CORTEO

Illuminated menu display made of high-quality anodized aluminum with a front screen made of specially hardened acrylic safety glass. Easy to open and close with a key (included in delivery). Inserts can be very easily attached to the magnetic, writable rear panel with magnets (please order at the same time). Extremely weatherproof and durable. Power: 2.4 W, connected load 230 V. Cable length: 3.5 m at menu display stand for 2x DIN A4 sheets, 5 m at menu display stand for 4x DIN A4 sheets, 1.4 m at menu display board.

Material: Anodized aluminum and acrylic glass. Suitable for outdoor use! Lockable! Illuminated!

- Foldable on all 4 sides
- Can be used horizontally and vertically

Snap frame
MATTEO, from

14⁹⁹

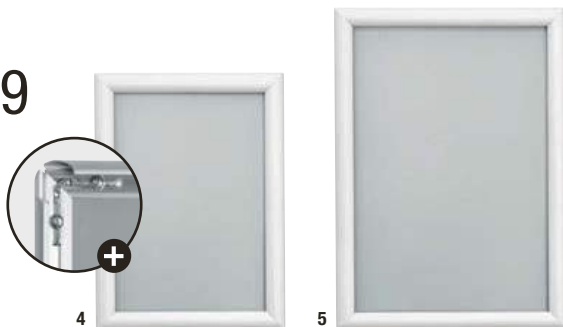

4

5



Snap frame MATTEO

The 25 mm wide profile is silver anodized and can be opened for easily inserting information on all four sides. Due to the plastic back and the UV-stabilized anti-reflective protection screen, this panel is weather-resistant and particularly stable. The snap frames can be hung vertically or horizontally. Delivery without mounting material.

Suitable for outdoors!

	WxH cm (outside)	WxH cm (inside)	Suitable for	Ref.	Piece €
4	24.1x32.8	19x27.7	DIN A4	10089046	14,99
5	32.8x45.1	27.7x40	DIN A3	10089048	19,99

Menu display stand
UTAH

139⁰⁰



6

Menu display stand UTAH

The snap frame can be used horizontally or vertically. Suitable for the presentation of one DIN A3 page.

Material: Aluminum. For indoors only!

	WxDxH cm	Ref.	Piece €
6	33x40x107	10077510	139,00

For your menus

■ Lockable



7



8

Menu display board
QUENTIN, from
259⁰⁰

Menu display board QUENTIN

These lockable aluminum menu display boards (incl. two keys) are ideal for outdoors and are equipped with impact-resistant ESG safety glass. The white aluminum back wall is writable with chalk markers and dry wipeable. Using magnets you can quickly and easily pin your offers in the showcase. Delivery without mounting material.

Suitable for outdoors!



	WxDxH cm	Suitable for	Weight kg	Ref.	Piece €
7	58.5x4.7x76	4x DIN A4	10.3	10095126	259,00
8	80.5x4.7x76	6x DIN A4	14.1	10095127	309,00

With integrated lighting!

■ Illuminated

■ Lockable

Menu display board
KLIMT, from
319⁰⁰



9



10

Menu display board KLIMT

Seduce your guests already at the entrance door - with the illuminated menu display board made of wrought iron, your offers look great right from the start! Delivery incl. mounting material. All items have side and back walls made of wood (weather-resistant lacquered). The front view - frame, roof and door - are made of wrought iron. Space for 3 or 4 DIN A4 sheets. Incl. cable (length 2 m), plug and key. Delivery incl. illuminant of energy efficiency class B for 4 W and A for 7 W.

Suitable for outdoors!



	WxDxH cm	Connected load	Weight kg	Ref.	Piece €
9	75x13x53	7 W/230 V	13.6	10077091	319,00
10	54x12x90	4 W/230 V	14.6	10093548	349,00



+49 8272 807 447



service@em-group.com



www.em-group.com

405



Easel
DALI
74,99

5

1



1

2

Easel DALI

Made of solid wood. Height adjustable, suitable for blackboards RENOIR. Depth opened 57.5 cm and closed 6.5 cm.

Suitable for indoors and protected outdoor areas!



	WxH cm	Weight kg	Color	Ref.	Piece €
1	60x159	2	walnut	10089438	74,99
2			black	30030642	74,99

■ Can be combined with easel DALI

Blackboard
RENOIR, from
49,99



3



4

Chalk marker
from
1,99



6

7

Blackboard RENOIR



Plastic blackboards with solid wood frame. Suitable for mounting on a wall, on an easel (e.g. easel DALI) or for hanging. Incl. mounting material.

Material: Wood and plastic. Suitable for indoors and protected outdoor areas!

	WxH cm	WxH cm (labeling area)	Weight kg	Color	Ref.	Piece €
3	60x80	50x70	1.9	walnut	10089487	49,99
4				black	30026782	49,99
5	70x90	60x80	2.3	walnut	10089488	63,99
				black	30026781	63,99

Chalk marker

Suitable for all smooth surfaces such as VEGA blackboards, glass, mirrors and much more. Easy to remove with a damp cloth. Available in three different widths.

Width	2 mm	6 mm	15 mm
6 white	10079275	10079018	10079019
7 red	10079277	10079022	10079023
Piece €	1,99	2,59	4,09

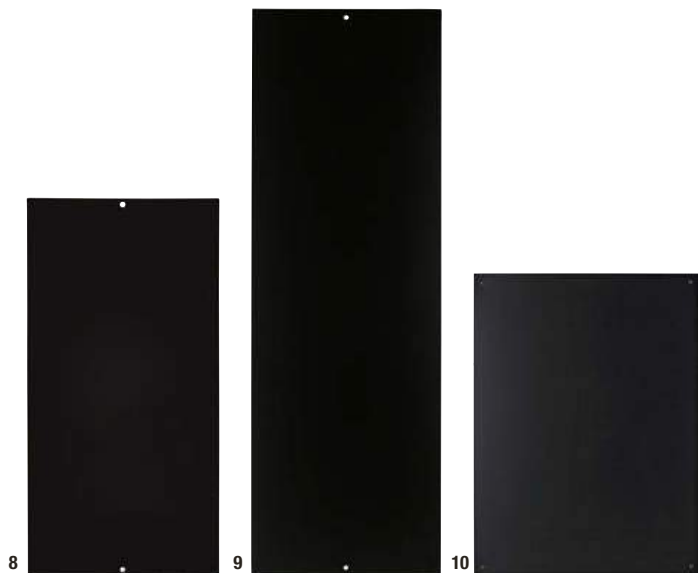

- Suitable for outdoors
- Can be used horizontally and vertically
- Easy to clean



Blackboard WILLIAM, from
39⁹⁹

Blackboard WILLIAM



Blackboard without frame made of 3 mm thick melamine plastic. The blackboards can be hung horizontally or vertically. Incl. mounting material.

Suitable for indoors and outdoors.

	WxH cm	Weight kg	Ref.	Piece €
8	50x100	2.2	10079169	39,99
	50x120	2.4	10079170	44,99
9	50x150	3	10079171	54,99
	50x170	4.3	10079172	64,99
10	60x80	2	10089367	44,99
	100x120	4.5	10089368	89,99

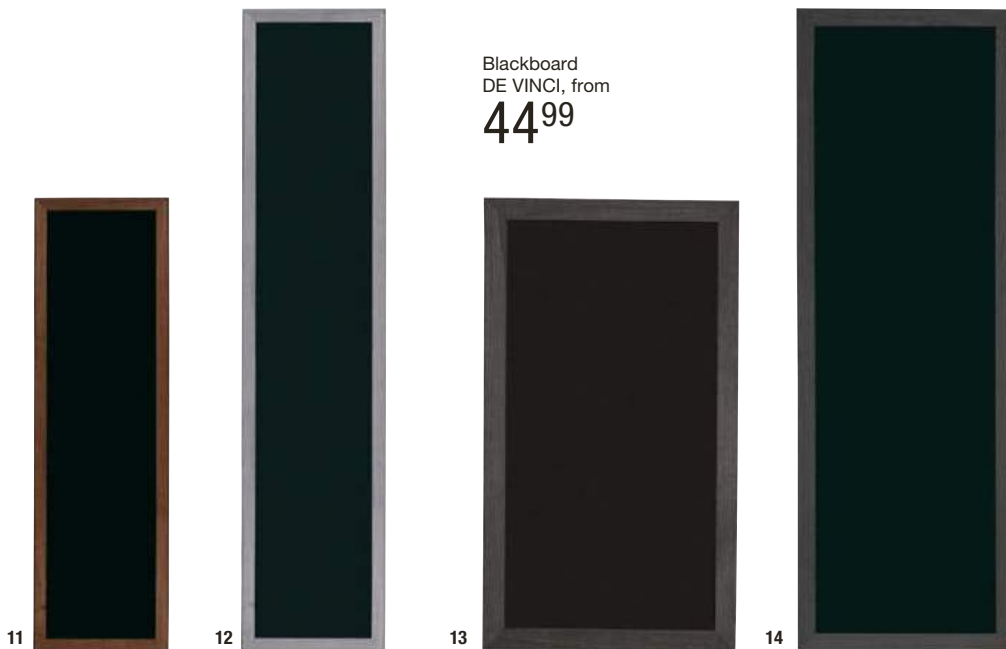

Blackboard DE VINCI, from
44⁹⁹

Blackboard DE VINCI

Blackboard made of plastic with a solid wood frame. For installation on a wall, on an easel or for hanging. Incl. mounting material.

Printable on request! Suitable for indoors and protected outdoor areas!

	WxH cm	WxH cm (labeling area)	Weight kg	Color	Ref.	Piece €
11	35x120	25x110	1.5	walnut	30030648	44,99
				grey	30030644	44,99
				black	30030647	44,99

	WxH cm	WxH cm (labeling area)	Weight kg	Color	Ref.	Piece €
12	35x170	25x160	2	walnut	30030646	64,99
				grey	30030645	64,99
				black	30030649	64,99
13	56x120	48x112	2.5	walnut	10089513	64,99
				grey	10089509	64,99
14	56x170	48x162	3.4	black	30030768	64,99
				walnut	10089514	84,99
				grey	10089510	84,99
				black	30030653	84,99

Blackboard
BAROCK
89⁹⁹



1

Streetboard
DONATIEN
119⁰⁰



3



Chalk marker
see p. 403 and at

www.em-group.com



- Foldable
- Easy to clean



3



5



7



1



2



4



6



8

Blackboard BAROCK

Made of plastic with a solid wood frame. Incl. mounting material for hanging.
Suitable for indoors and protected outdoor areas!



	WxH cm	WxH cm (labeling area)	Weight kg	Color	Ref.	Piece €
1	56x96	41x84	2.3	walnut	10089507	89,99
2	99x58	83x46	2.6	walnut	10089508	89,99

Streetboard and blackboard DONATIEN



Blackboard and streetboard made of plastic with a wide frame made of solid ash wood - perfect for the current vintage trend. The blackboard can be used horizontally and vertically and can be fixed to the wall (mounting material not included). The streetboard can be inscribed on both sides and has plastic glides on the feet. Combine blackboard and streetboard for a uniform look!

Suitable for indoors and protected outdoor areas!

		WxH cm	WxH cm (labeling area)	Weight kg	Color	Ref.	Piece €
3	Street-board	56x100	40x84	7.2	grey	30002282	119,00
					brown	30002281	119,00
5	Black-board	56x100	40x84	5	grey	10095221	59,99
brown					10095219	59,99	
7					grey	10095223	74,99
8					brown	10095222	74,99



Stand
PICCOLO, from
9,99



Easel
CONSILIO
9,99



Holder for the blackboard



Rear view



13



14

Stand PICCOLO

Table stand that can be labeled on both sides - an eye-catcher on your tables! With solid beech wood base, stained and lacquered. Blackboard made of plastic, can be written with our chalk markers (please order at the same time).

Material: Beech wood and plastic.

	LxWxH cm	Color	Ref.	Pcs./pack	Pack €	Piece €
9	8x10x16	black	30040443	2	19,98	9,99
10		dark brown	30040444	2	19,98	9,99
11	8x21x31	black	30040410	2	29,98	14,99
12		dark brown	30040411	2	29,98	14,99

Easel CONSILIO

Mini easel for the table made of solid, laquered beech wood. With blackboard that can be easily removed for labelling.

Material: Beech wood. Foldable! Combinable!

	LxWxH cm	Color	Ref.	Pcs./pack	Pack €	Piece €
13	14x15.5x25.5	black	30040409	2	19,98	9,99
14		dark brown	30040408	2	19,98	9,99

Base
TRISTAN, from
9,99

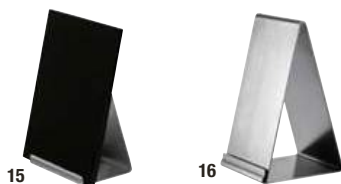

15

16

Base TRISTAN

Optimally suited to present the menu UNICO with a secure stand on your tables. Also suitable for acrylic boards.

Material: Chrome-nickel stainless steel 14/4.

	LxWxH cm	Ref.	Pcs./pack	Pack €	Piece €
15	6x8x9	10049624	2	19,98	9,99
16	8.2x8x14	10051120	2	25,98	12,99

Mini easel
RUBENS
5,49

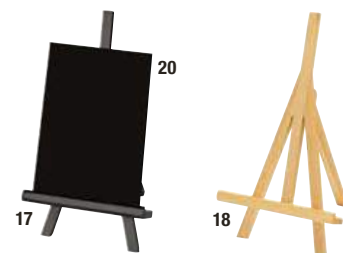

17

18

Mini easel RUBENS

Offers, recommendations and much more is presented perfectly with this wooden mini easel.

Material: Beech wood, stained or lacquered.

	WxH cm	Color	Ref.	Pcs./pack	Pack €	Piece €
17	12x21	black	10089435	2	10,98	5,49
18		natural	10089434	2	10,98	5,49

Blackboard and plastic base STANKO

Made of plastic. Blackboards can be labeled on both sides. Simply plug into the plastic base - replaceable at any time.

	WxH cm	Shape	Ref.	Pcs./pack	Pack €	Piece €
19	10.5x14.8	DIN A6	10070692	5	8,45	1,69
20	14.8x21	DIN A5	10070640	5	13,45	2,69
21	14x9	half round	10070660	5	12,95	2,59
22	21x29.7	DIN A4	30026435	5	18,45	3,69

	ØxH cm	Ref.	Pcs./pack	Pack €	Piece €
23 Base	7x2	10070639	5	12,95	2,59

Blackboard
STANKO, from
1,69



19

20

Plastic base
2,59



21



22

MENU SPRINGBACK BINDER PERRON AND CALGARY

Rain, scratches, stains - all this cannot harm the menus PERRON and CALGARY. They are made of an extremely robust, hard-wearing and water-repellent material that also feels wonderfully natural. The easy to use springback binder function makes it easy to replace the inserts. Perfect for intensive and long lasting use!

VEGA Favorites



Springback binder CALGARY without embossing A4
WxH 22.5x30.5 cm
Matching insert sheets DIN A4
Ref. grey 30026703
Ref. brown 30026702
Piece € 34,99



Springback binder PERRON without embossing A4
WxH 22.5x30.5 cm
Matching insert sheets DIN A4
Ref. taupe 30026711
Ref. grey 30026713
Piece € 34,99



Springback binder PERRON with embossing MENU A4
WxH 22.5x30.5 cm
Matching insert sheets DIN A4
Ref. taupe 30026715
Ref. grey 30026717
Piece € 34,99

Springback binder
PERRON

34⁹⁹



Personalizable on
request

Robust and almost indestructible



Extremely hard-wearing, scratch and tear-resistant: Looks like new for a long time!



Water-repellent: Also ideal for outdoor use

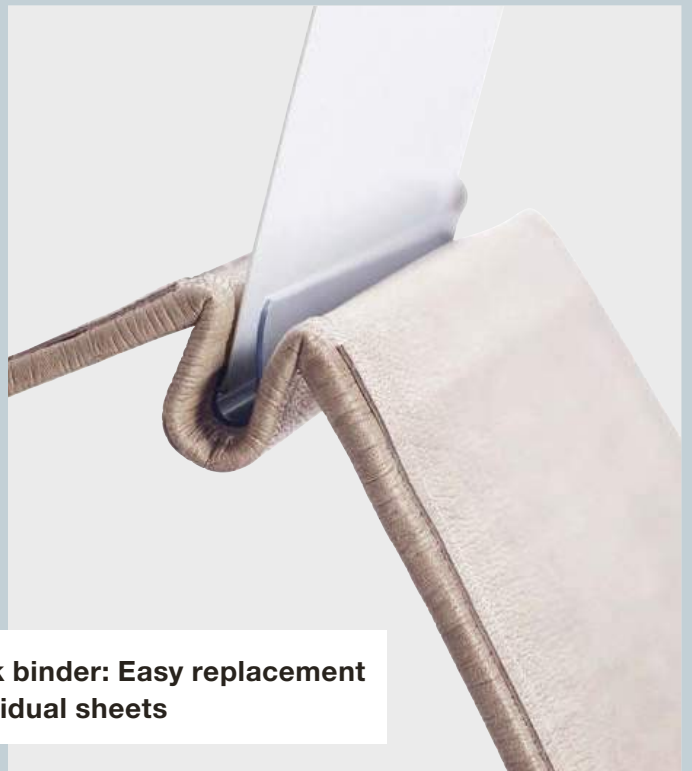

Springback binder: Easy replacement of the individual sheets





Menu softcover
PARSON, from
24⁹⁹

- Incl. 3 double clear pockets (= 12 sides)
- Vintage look in wood look



Menu softcover
PASQUA, from
24⁹⁹

- Incl. 3 double clear pockets (= 12 sides)
- In deceptively real cork look

Menu softcover PARSON and PASQUA

Handmade menus made in European Union. Extremely hard-wearing, scratch and tear-resistant cover material that can hardly be distinguished from natural materials. Great feel, impermeable to dirt and moisture, water-repellent, tensile and wear-resistant. Easy to clean, wipeable. An ideal material for intensive and long-term use, also ideal for outdoors - saves money and time in the hectic daily routine! Available in different sizes and with or without embossing. The special feature: 3 double clear pockets for 12 sides are already included. Additional pockets can be easily ordered. Easy replacement of the pockets by clip closure.

Material: Polyurethane. Easy to clean! Insensitive to stains! Hard-wearing!



Your advantage with PARSON + PASQUA

Extremely hard-wearing, ideally suited for intensive use:
Saves time and money!



1



2



4



6

Menu holder softcover PARSON

	WxH cm	Matching insert sheets	Color	Ref.	Piece €
1 Without embossing A4	23.5x32.5	DIN A4	brown	30026751	29,99
2 Without embossing A5	18x23.8	DIN A5	brown	30026747	24,99
3 With embossing DELICIOUS & TASTY A4	23.5x32.5	DIN A4	brown	30026750	29,99
With embossing DELICIOUS & TASTY A5	18x23.8	DIN A5	brown	30026746	24,99

Menu holder softcover PASQUA

	WxH cm	Matching insert sheets	Color	Ref.	Piece €
4 Without embossing A4	23.5x32.5	DIN A4	natural	30026767	29,99
			brown	30026771	29,99
5 Without embossing A5	18x23.8	DIN A5	natural	30026762	24,99
			brown	30026769	29,99
6 MENU A4	23.5x32.5	DIN A4	brown	30026765	29,99

Clip closure
PARSBORROW

0⁰⁹



7

Clear pocket
PEERS, from

1²⁹



8

Clear pocket
PLAMONDON, from

0⁷⁹

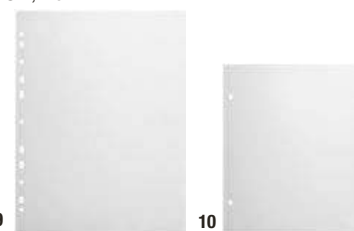

9

10

Clip closure PARSBORROW

Spare clips for the softcover menus PARKSVILLE, PARSON and PASQUA.

Material: Metal.

	HxØ cm	Ref.	Pcs./ pack	Pack €	Piece €
7	1.9x0.5	30026701	50	4,50	0,09

Clear pocket PEERS

Double clear pockets for softcover menus PARKSVILLE, PARSON and PASQUA. Available in different sizes.

Material: Plastic. Easy to exchange! 40 sides!

	Matching insert sheets	Ref.	Pcs./ pack	Pack €	Piece €
8	DIN A4	30026737	10	14,90	1,49
	DIN A5	30026738	10	12,90	1,29

Clear pocket PLAMONDON

Suitable clear pockets for menu PEROW.

Material: Plastic. Easy to exchange! 20 sides!

	Matching insert sheets	Ref.	Pcs./ pack	Pack €	Piece €
9	DIN A4	30051069	10	8,90	0,89
10	DIN A5	30051072	10	7,90	0,79



■ Incl. 3 double clear pockets (= 12 sides)



11



12



15



16



17



18



13



14



19



20



21



22

Find more products at
www.em-group.com

Menu softcover PARKSVILLE

Handmade menus made in European Union. Extremely hard-wearing, scratch and tear-resistant cover material, in natural-looking linen texture. Great feel, impermeable to dirt and moisture, tensile and wear-resistant and water-repellent. Easy to clean, wipeable. An ideal material for intensive and long-term use, also ideal for outdoors - saves money and time in the hectic daily routine! Available in different sizes and with or without embossing. The special feature: 3 double clear pockets for 12 sides are already included. Additional pockets can be easily ordered. Easy replacement of the pockets by clip closure.

Material: Polyurethane. Easy to clean! Insensitive to stains! Hard-wearing!

	WxH cm	Matching insert sheets	Color	Ref.	Piece €	
11	Without embossing A4	23.5x32.5	DIN A4	anthracite	30026712	29,99
12	Without embossing A5	18x23.8	DIN A5	anthracite	30026732	24,99
13	With embossing MENU A4	23.5x32.5	DIN A4	anthracite	30026719	29,99
14	With embossing MENU A5	18x23.8	DIN A5	anthracite	30026735	24,99

Menu PEROW

Durable and easy-care menus in cotton look. Insensitive to stains. Available with embossing "Menu" or without embossing. Please order matching clear pockets PLAMONDON separately.

Material: Polyurethane. Insert system: Chicago screws. UV-resistant!

	WxH cm	Matching insert sheets	Color	Ref.	Piece €	
15	Without embossing A4	24.4x32.2	DIN A4	anthracite	30051063	34,99
16				taupe	30051064	34,99
17	Without embossing A5	19.6x24.7	DIN A5	anthracite	30051071	29,99
18				taupe	30051070	29,99
19	With embossing MENU A4	24.4x32.2	DIN A4	anthracite	30051067	34,99
20				taupe	30051065	34,99
21	With embossing MENU A5	19.6x24.7	DIN A5	anthracite	30051068	29,99
22				taupe	30051066	29,99



Menu SULLY, from 9,99

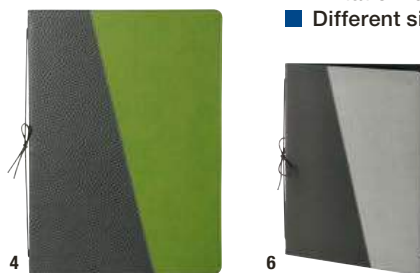
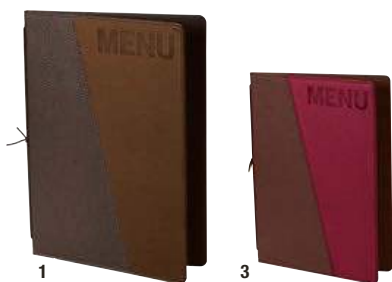

- Imitation leather
- Different sizes

Menu SULLY

Using 2 different types of leather. The separately available double clear pockets (must be ordered separately) are fastened with an inner cord.

Material: Imitation leather. Insert system: Cord.

	WxH cm	Matching insert sheets	Color	Ref.	Piece €
1	25x34	DIN A4	brown	10027274	12,99
2			bordeaux	10027273	12,99
			green	10027275	12,99
			grey	10027276	12,99
3	18x24	DIN A5	brown	10027729	9,99
			bordeaux	10027731	9,99
			green	10027728	9,99
			grey	10027730	9,99

	WxH cm	Matching insert sheets	Color	Ref.	Piece €
4	25x34	DIN A4	brown	10027818	12,99
			bordeaux	10027817	12,99
			green	10027819	12,99
			grey	10027820	12,99
5	18x24	DIN A5	brown	10027725	9,99
			bordeaux	10027727	9,99
			green	10027724	9,99
			grey	10027726	9,99

	Size	Thickness my	Ref.	Pcs./pack	Pack €	Piece €
Double clear pockets folded	DIN A4	200	10094410	10	22,90	2,29
	DIN A5	200	10094422	10	12,90	1,29



Menu VINTAGO, from 19,99



Menu VINTAGO

Made of fancy linen, a coarse linen fabric with an appealing print. With corner protection. Delivery incl. 5 insert cartons. Additional sides (3 pieces = 6 sides) can be ordered separately.

Material: Linen fabric. Insert system: Inside Chicago screws.

	WxH cm	Matching insert cartons	Number sides	Color	Ref.	Piece €
7	25x34.7	DIN A4	2	beige	10006135	24,99
8				blue	30030736	24,99
				grey	30030735	24,99
9	18.5x25.1	DIN A5	2	beige	10006134	19,99
10				blue	30030738	19,99
				grey	30030737	19,99

	Size	Ref.	Pcs./pack	Pack €
Insert carton	DIN A4	30040534	3	13,99
	DIN A5	30040535	3	12,99



Menu
PERDUE, from
24⁹⁹



Menu PERDUE

Made of particularly sustainable material. Nonetheless insensitive to stains, easy to clean and waterproof. With innovative magnet system: Holds 10 sheets of paper with a thickness of 120 g.

Material: Washpaper. Insertion system: Magnet. Easy to clean! Hand wash!

	WxH cm	Matching insert sheets	Ref.	Piece €
11 Without embossing A4	23x32.5	DIN A4	30045546	29,99
Without embossing A5	16.6x24	DIN A5	30045548	24,99
12 With embossing MENU A4	23x32.5	DIN A4	30045547	29,99
13 With embossing MENU A5	16.6x24	DIN A5	30045549	24,99



Menu
PIPESTONE, from
24⁹⁹



Menu PIPESTONE

Particularly sustainable product because it is made from renewable raw materials. Insensitive to stains and waterproof. With innovative magnet system: Holds 10 sheets of paper with a thickness of 120 g.

Material: Outside: Bamboo, inside: Washpaper. Insert system: Magnet. Easy to clean! Wet wipeable!

	WxH cm	Matching insert sheets	Ref.	Piece €
14 Without embossing A4	23x32.5	DIN A4	30045540	29,99
Without embossing A5	16.6x24	DIN A5	30045539	24,99
15 With embossing DELICIOUS & TASTY A4	23x32.5	DIN A4	30045541	29,99
16 With embossing DELICIOUS & TASTY A5	16.6x24	DIN A5	30045537	24,99
17 Bill presenter	23.5x12.9		30045538	14,99



Sustainable and personalizable

Washpaper

Is a modern, ecological paper that is gaining more and more recognition. It is a special mixture of cellulose that prevents paper fibers from dissolving in water and strengthens their structure, which is similar to the appearance of leather. The products made from it can easily be washed by hand or wiped with a very damp cloth.

Bamboo

Light, durable, waterproof, ecological - a quickly renewable and natural raw material. When felling bamboo, the root system remains intact, so new plants can constantly grow again.

Customizing

Personalize your menus!

Refine our menus with your logo. Whether print or embossing - your menus look high-quality and underline the character of your house.



Menu
OSCAR, from
18⁹⁹

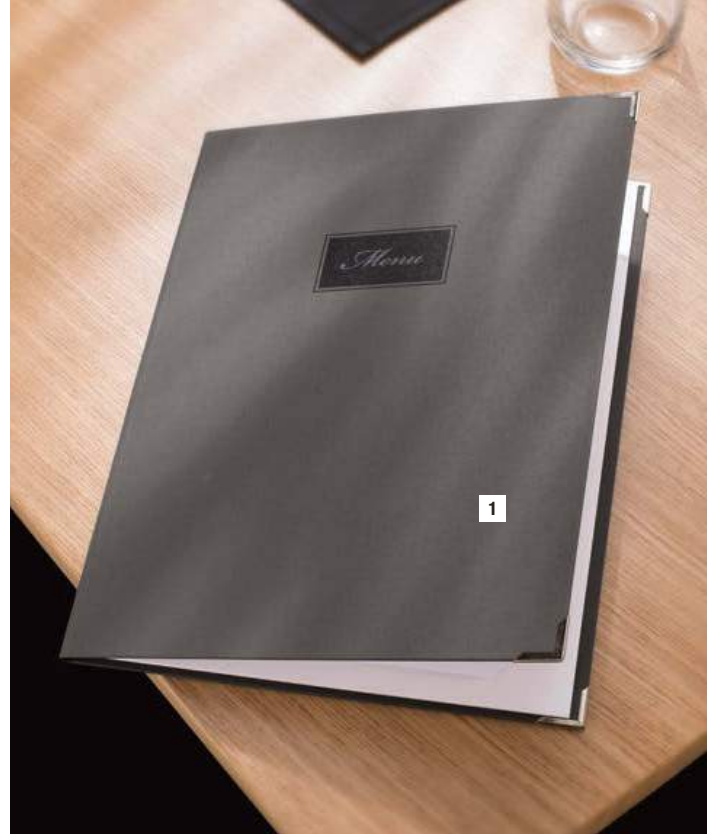

1



2



3



4



5



6

- Menu DIN A4 and A5
- Book cover material

Bill presenter
OSCAR
14⁹⁹

Menu and bill presenter and box made of book cover material OSCAR

High-quality fabric with acrylic coating. Moisture and dirt-repellent.

Material: Book cover material. Corner protection: Silver.

Insert system: Corners.

	Dimensions cm	Matching insert sheets	Number sides	Color	Ref.	Piece €
1 With embossing MENU A4 portrait	24.8x33.1 (WxH)	DIN A4	6	grey	10027324	23,99
			8	grey	10027325	25,99
			10	grey	10027326	27,99

	Dimensions cm	Matching insert sheets	Number sides	Color	Ref.	Piece €
2 With embossing MENU A4 landscape	33.1x24.8 (WxH)	DIN A4	6	grey	10027317	23,99
			8	grey	10027318	25,99
3 With embossing CAFÉ A5 landscape	24.8x18.7 (WxH)	DIN A5	6	grey	10049980	18,99
			10	grey	30036967	23,99
4 With bossing MENU A5 portrait	18.7x24.8 (WxH)	DIN A5	6	grey	30036969	18,99
			10	grey	30036967	23,99
		Dimensions cm		Color	Ref.	Piece €
5 Bill presenter		23x13 (LxW)		grey	10049940	14,99
6 Bill box		19.2x11x2.4 (LxWxH)		grey	10049939	17,99

Easy-care imitation leather

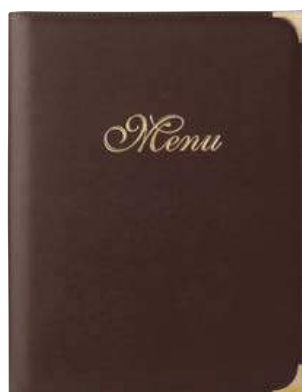

7



8



9



10



11

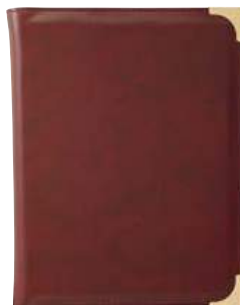

12



13

- Imitation leather
- With or without embossing

Menu
ARAGON, from

5⁹⁹

Menus made of imitation leather ARAGON

The menus are thanks to the high-quality imitation leather absolutely easy-care. All models with gold-colored metal corners, 4 concealed Chicago screws for attaching clear pockets of size DIN A4 or DIN A5 and gold embossing. Also available without embossing. Please order clear pockets at the same time.

Material: Imitation leather. Corner protection: Gold.
Insert system: Inside Chicago screws.

	WxH cm	Matching insert sheets	Color	Ref.	Piece €
7 With embossing MENU A4 portrait	25.5x33	DIN A4	light brown	10059697	7,49
			brown	10059699	7,49
			bordeaux	10059698	7,49
			black	10059700	7,49
8			blue	10059701	7,49

	WxH cm	Matching insert sheets	Color	Ref.	Piece €
9 A4	25.5x33	DIN A4	light brown	10059672	6,99
			brown	10059671	6,99
			bordeaux	10059674	6,99
10			blue	10059670	6,99
11 A5	19.5x24.5	DIN A5	light brown	10059872	5,99
			brown	10059871	5,99
			bordeaux	10059874	5,99
			blue	10059870	5,99

	Size	Thickness my	Ref.	Pcs./ pack	Pack €	Piece €
Clear pocket	DIN A4	200	10094405	10	7,90	0,79
	DIN A5	200	10094406	10	6,90	0,69



Over 20,000 products in our online shop!

Order easy and comfortable online:
95 % in stock, fast delivery, always new products and offers!

Discover our new products!



The complete range at a glance!

Get inspired online now!

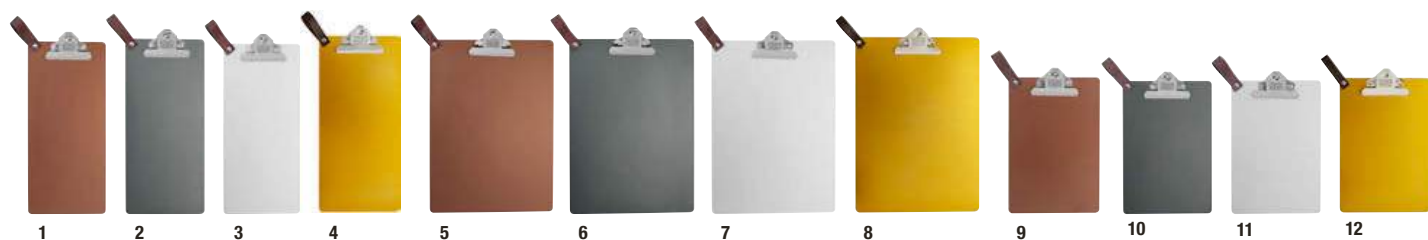
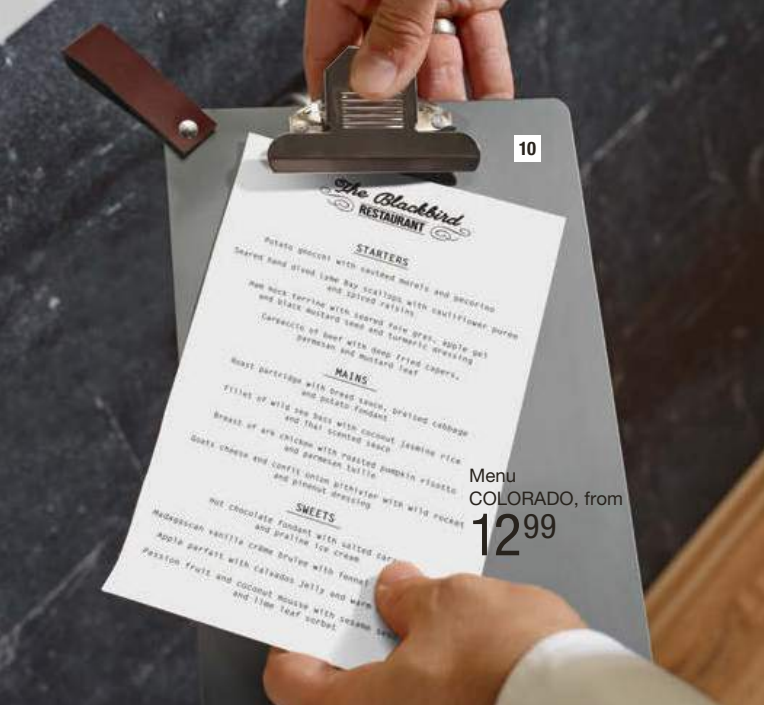

Menu COLORADO

Robust and insensitive to scratches and external influences. With integrated clip for easy exchange of the daily menu and loop made of imitation leather to hang up the menu.

Material: Anodized aluminum, loop made of imitation leather. **Robust!**

	WxH cm	Matching insert sheets	Color	Ref.	Piece €
1	14.5x32	Bar size	copper	30002294	12,99
2			anthracite	30002321	12,99
3			silver	30002295	12,99
4			gold	30047220	12,99

	WxH cm	Matching insert sheets	Color	Ref.	Piece €
5	23x32	DIN A4	copper	30002285	17,99
6			anthracite	30002318	17,99
7			silver	30002286	17,99
8			gold	30047221	17,99
9	16.4x24.5	DIN A5	copper	30002297	12,99
10			anthracite	30002296	12,99
11			silver	30002283	12,99
12			gold	30047222	12,99



Menu and clipboard made of carton LENIO

The menu cover is made of cellophaned carton in wood look. The separately available double pockets (must be ordered separately) are attached with the inner cord. Simply attach the desired size at the clipboard.

Material: Carton, cellophaned. **Insert system:** Cord!

	WxH cm	Matching insert sheets	Color	Ref.	Piece €
13	16.3x33.5	Bar size	anthracite	10006095	17,99
14			grey	10006094	17,99
15			sand	30002273	17,99
16	23x32	DIN A4	anthracite	10006098	17,99
15			grey	10006097	17,99
16			sand	30002267	17,99

	WxH cm	Matching insert sheets	Color	Ref.	Pcs./pack	Pack €	Piece €
17	23.8x32.6	DIN A4	anthracite	10029308	10	22,90	19,99
			grey	10029311	10	22,90	19,99
			sand	30002271	10	21,90	19,99
18	23.8x32.6	DIN A4	anthracite	10029307	10	22,90	19,99
			grey	10029310	10	22,90	19,99
			sand	30002270	10	21,90	19,99

	Matching insert sheets	Thickness my	Ref.	Pcs./pack	Pack €	Piece €
Double clear pocket	DIN A4	200	10094410	10	22,90	2,29
	Bar size	200	10008522	10	21,90	2,19

Menu stand
PEEBLES

16⁹⁹

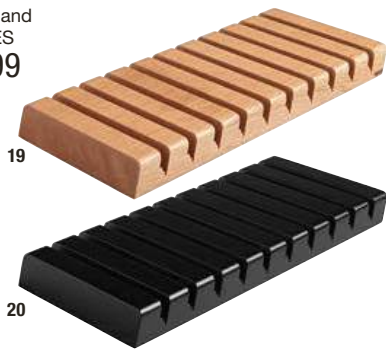

Menu stand PEEBLES

Menu stand for daily menus, suitable for our menus LENIO, COLORADO and UNICO. Space for 10 menus. Not suitable for dishwashers.

Material: Real wood. Lacquered.

	LxWxH cm	Color	Ref.	Piece €
19	33.2x15x3	oak	30033050	16,99
20		black	30033049	16,99



Find more products at

→ www.em-group.com

Menu
UNICO, from

15⁹⁹

■ Delivery including clip!



Base
TRISTAN, from

9⁹⁹



Base TRISTAN

Optimally suited to present menu UNICO with a secure stand on your tables. Also suitable for acrylic boards.

Material: Chrome-nickel stainless steel 14/4.

	LxWxH cm	Ref.	Pcs./pack	Pack €	Piece €
21	6x8x9	10049624	2	19,98	9,99
22	8.2x8x14	10051120	2	25,98	12,99

Menu UNICO

Carefully processed clipboard. Easy replacement of the daily menu with stainless steel clip, which is included. Not suitable for dishwashers. If you want to set up the menus, just combine them with base TRISTAN.

Material: Real wood. Veneered. Clip: Chrome steel 18/0.

	WxH cm	Matching insert sheets	Color	Ref.	Piece €
23	17x28.5	DIN A5	oak	10051114	15,99
24			walnut	10051117	15,99
25			vintage white	30023957	15,99
26	14.5x37.2	Bar size	oak	10051115	16,99
27			walnut	10051119	16,99
28			vintage white	30023953	16,99
29	23x37.2	DIN A4	oak	10051113	21,99
30			walnut	10051116	21,99
31			vintage white	30023956	21,99

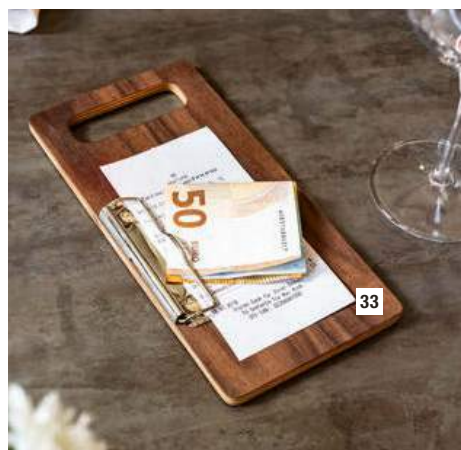

Bill tray
UNICO

9⁹⁹

■ With stable clip



Bill tray UNICO

With sturdy clip to fix bills, credit cards or banknotes. Not suitable for dishwashers.

Material: Real wood. Veneered.

	WxH cm	Color	Ref.	Piece €
32	14x24	oak	30024264	9,99
33		walnut	30024265	9,99
34		vintage white	30024263	9,99



Menu PARTHIA

With practical handle. If you want to set up the menu, simply combine it with the menu stand PEEBLES. Matching insert sheets must be ordered at the same time. Not suitable for dishwashers.

Material: Real wood veneered. Wet wipeable! Exclusively available at VEGA!

		WxH cm	Matching insert sheets	Color	Ref.	Piece €
1				oak	30045375	24,99
2	A4	34x35.1	DIN A4	walnut	30045374	24,99
3				vintage white	30045373	24,99
4				oak	30045390	17,99
5	A5	26x25.6	DIN A5	walnut	30045391	17,99
6				vintage white	30045389	17,99
7				oak	30045385	29,99
8	A4 landscape	41.5x26.2	A4 landscape	walnut	30045383	29,99
9				vintage white	30045384	29,99
10				oak	30045386	19,99
11	Bar size	22.2x33.7	Bar size	walnut	30045387	19,99
12				vintage white	30045388	19,99



For a modern presentation of your menu

Clear pocket
2,19



13

Clear pocket, from
0,69



14

Clear double pocket folded, from
1,29



15

Chicago screw system
- Strong hold
- Easy exchange of the pockets

Clear pocket
Open at the top, clear on both sides.
Material: Polyvinylchloride (PVC).

	Matching insert sheets	Thickness my	Ref.	Pcs./ pack	Pack €	Piece €
13	DIN A4	200	10027560	10	21,90	2,19

Clear pocket for for menus
With 4 holes. Open at the top, clear on both sides.
Material: Polyvinylchloride (PVC).

	Matching insert sheets	Thickness my	Ref.	Pcs./ pack	Pack €	Piece €
14	DIN A4	200	10094405	10	7,90	0,79
	A4 landscape	200	10094407	10	8,90	0,89
	DIN A5	200	10094406	10	6,90	0,69
	Bar size	200	30045382	10	7,90	0,79

Clear double pocket folded
Attached by the internal cord of the menu. Folded from DIN A3 to A4 and from A4 to A5. Open at the top.
Material: Polyvinylchloride (PVC).

	Matching insert sheets	Thickness my	Ref.	Pcs./ pack	Pack €	Piece €
15	DIN A4	200	10094410	10	22,90	2,29
	Bar size	200	10008522	10	21,90	2,19
	DIN A5	200	10094422	10	12,90	1,29



Menu
PACOFI, from
9,99

Find more products at
→ www.em-group.com

Menu PACOFI

In high-quality processed professional quality. With oblique edge and robust clip for easy insertion or exchange of the daily menu and leather handle for hanging.

**Material: Molded plywood, lacquered. Insert system: Clip!
Easy to clean! Wet wipeable!**

	LxWxH cm	Color	Ref.	Piece €
16 With oblique edge	28.7x15.1x0.3	black	30047277	9,99
17		white	30047276	9,99
18 With straight edge	31.2x17.8x0.4	black	30047272	12,99
19		white	30047274	12,99



Menu with foot
PACQUET
17,99

Menu with foot PACQUET

In high-quality processed professional quality. With robust clip for easy insertion or exchange of the daily menu. Easy to set up the daily menu thanks to integrated foot.

Material: Molded plywood, lacquered. Easy to clean! Wet wipeable!

	LxWxH cm	Matching insert sheets	Color	Ref.	Piece €
20	32.4x25.2x0.4	DIN A4	black	30051452	17,99
21			white	30051451	17,99



Place card stand
QUADER, from
4⁹⁹

■ Can be used horizontally or vertically

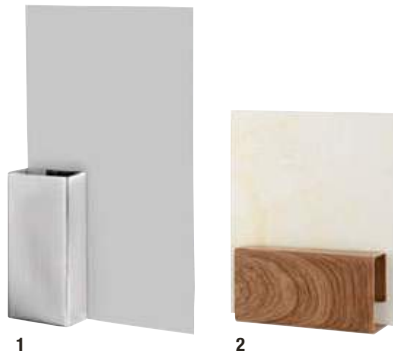

Place card stand QUADER

For a discreet presentation of your menus or offers.

Material: Chrome-nickel stainless steel 18/10.

	LxWxH cm	Color	Ref.	Pcs./ pack	Pack €	Piece €
1	8.5x4.2x4.2	silver	10049515	2	9,98	4,99
2		brown	10049906	2	11,98	5,99

Place card stand
5⁹⁹



Place card stand

For the presentation of your menus or offers. The wooden parts are held together with 2 stainless steel rivets 18/10.

Material: Real wood.

	LxWxH cm	Color	Ref.	Piece €
3	8.5x4.4x6.5	walnut	10049516	5,99

Menu holder, from
0⁹⁹



Menu holder and card

With cube-shaped base and metal clip.

Material: Acrylic or pine wood.

	Material	LxWxH cm	Ref.	Pcs./ pack	Pack €	Piece €
4	Acrylic	2.5x2.5x11.4	10099504	5	4,95	0,99
		2.5x2.5x14.5	10099505	5	5,45	1,09
5	Wood	2.5x2.5x11.5	10089945	5	6,95	1,39

Place card stand
9⁹⁹

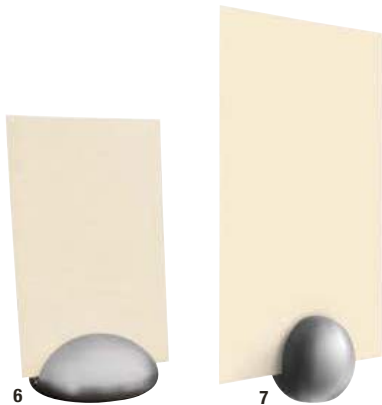

Place card stand

For a stylish and discreet presentation of your menus or offers.

Material: Aluminum.

	ØxH cm	Color	Ref.	Piece €
6	7.2x3.4	silver	10049590	9,99
7	5.2x4.8	silver	10049604	9,99

Menu holder
2⁹⁹



Menu holder

For the presentation of your menus.

Material: Chrome-nickel stainless steel 18/8.

	LxWxH cm	Ref.	Piece €
8	8x7.5x2	10040057	2,99

Menu holder
8⁴⁹



Menu holder

In heavy quality. For menus made of paper up to 4 sides or your own creations.

Material: Chrome-nickel stainless steel 18/8.

	ØxH cm	Ref.	Piece €
9 Menü	12x12.5	10077330	8,49
10 Knife and fork	12x12.5	10077329	8,49

Place card stand
PAISLEY
9⁹⁹



Place card stand PAISLEY

Place card stand for your menus. Heavy quality for a safe stand. With slot in a thickness of 1.7 mm.

Material: Stainless steel. Easy to clean!

	LxWxH cm	Ref.	Pcs./ pack	Pack €	Piece €
11	2x10x2	30047278	5	49,95	9,99



Acrylic base

Ideal for the presentation of your daily specials. Easy to clean with hot water.

Material: Acrylic. Scratch-resistant!

Base, from
3⁰⁹

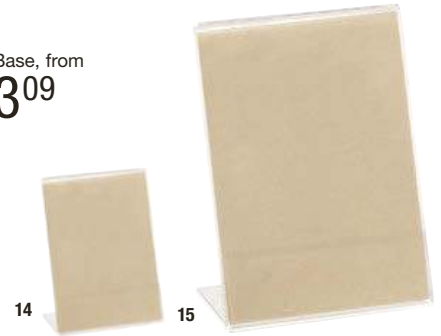

		LxWxH cm	Size	Ref.	Piece €
12	rectangular	10.5x10.5x8.5	DIN A7	10094420	3,09
		17.2x10.5x5	DIN A6	10094417	5,09
13	rectangular	23x15.1x5.5	DIN A5	10094416	6,99
14		7.5x10.5x5	DIN A7	10094421	3,29
15		30.6x21.1x10.1	DIN A4	10094415	6,09

Wallet
FRED
39⁹⁹

■ Leather



16

Holder pocket
ANTON
29⁹⁹



17

Wallet FRED

With 6 compartments for different bills, 1 compartment for coins, zipper pocket and outside compartment. Practical: The closure is adjustable in size - depending on how full the wallet is.

Material: Leather.

	LxW cm	Color	Ref.	Piece €
16	10.5x17.5	black	30003446	39,99

Holder pocket ANTON

With 2 large compartments for wallet and notepad. At the back there is another compartment with velcro closure. On the right, 1 loop ensures that you always have your pen at hand.

Material: Leather.

	LxW cm	Color	Ref.	Piece €
17	26x13	black	30003448	29,99



Wallet
LACARA
19⁹⁹

■ Leather



18

Bill presenter
6³⁹



19

Bill tray
3⁴⁹



20

Wallet LACARA

With variable metal buckle. With 7 interior compartments, 1 zipper pocket, 1 coin pocket and 1 outside pocket.

Material: Leather. Robust!

	LxW cm	Color	Ref.	Piece €
18	18x9.5	black	10070242	19,99

Bill presenter

Bill presenter made of imitation leather without print.

Material: Imitation leather.

	LxW cm	Ref.	Piece €
19	23x13	10079085	6,39

Bill tray

Tray with clip for the presentation of the bill.

Material: Chrome steel 18/0.

	LxW cm	Ref.	Piece €
20	17x10.5	10022533	3,49

Table number sign
14⁹⁹



21



22

■ Imitation leather

Bill presenter LIPURO
7⁹⁹



23



24

Table number sign

With double-sided number. Content 12 piece.

Material: Chrome steel 18/0. Stackable! Mirror polished!

	WxH cm	Table no.	Ref.	Pack €
21	5.2x4	1-12	30041079	14,99
		13-24	30041099	14,99
		25-36	30041100	14,99
		37-48	30041075	14,99
		49-60	30041077	14,99

Wallet, bill presenter and holder pocket LIPURO

The wallet has 1 large coin compartment, 5 compartments for bills and 1 compartment with zipper. The bill presenter consists of 2 slots and 2 inside compartments. The holder pocket has 1 large main compartment for the wallet and 2 slots for notepad and pen. Easy to attach to the belt.

Material: Imitation leather. Decorative seams! Easy to clean!

	Dimensions cm	Ref.	Piece €
22 Wallet	19x10.8 (LxW)	10029231	24,99
23 Bill presenter	23x13.5x0.5 (LxWxH)	10029233	7,99
24 Holder pocket	26x13.8 (LxW)	10029232	9,99