



VEGA

Hotel
Restaurant
Catering

Annual Catalog
Hotel equipment 2018

www.em-group.com



Welcome to VEGA

Guests want to have one thing in their hotel: To feel at home. To do so, you contribute considerably with your service and your ambience. Above all, there are the unexpected little pleasures that delight your guests: Extra-fluffy terry towels, exclusive fragrance compositions in the bathroom and fantastically comfortable beds. Design your hotel rooms with VEGA. We offer new concepts and inspirations, how to create a feel-good atmosphere with small details. Our products are practical and creative. They promise the highest comfort in the smallest space. In our hotel industry catalog you will find everything you need.

Renate Wenger

Renate Wenger,
Managing Director

The shown items can be found on the following pages:

- > Box spring bed complete set page 29
 - > Bed linen ROM page 53
-

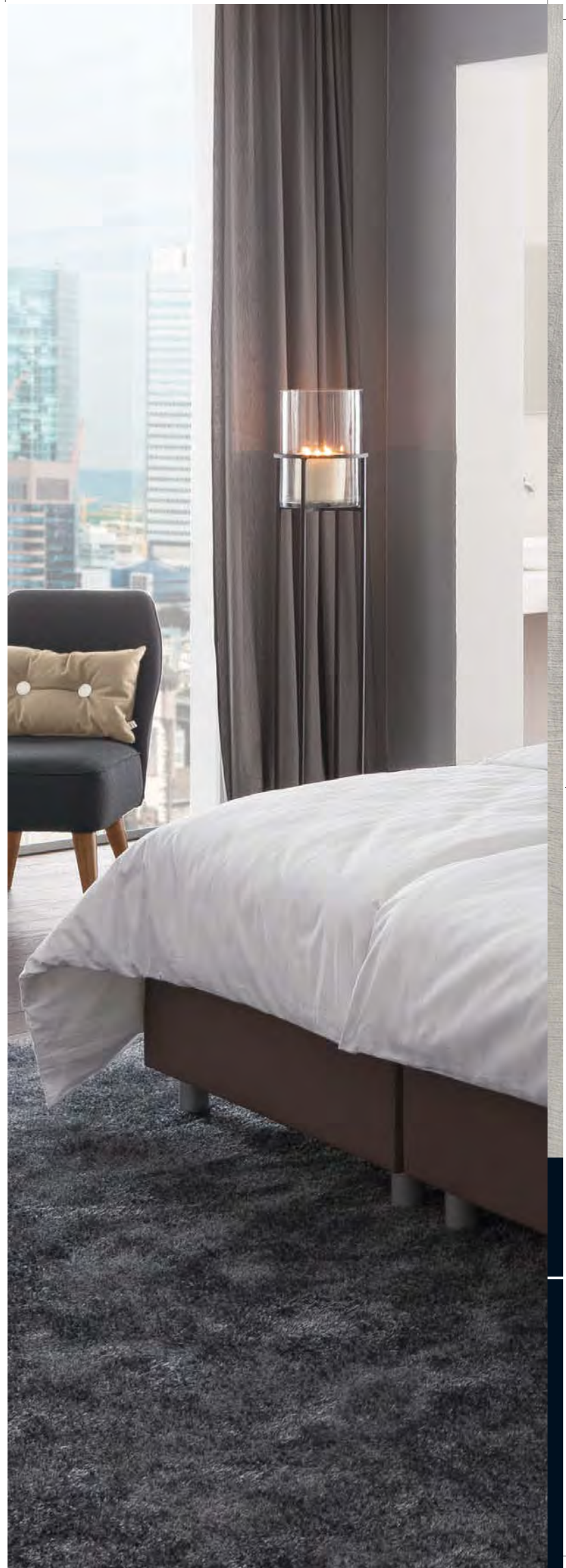



Inspire your guests

WITH PASSION AND PROFESSIONALISM

BATH & WELLNESS

- 6 Cosmetics
- 16 Terry
- 22 Bath accessories

HOTEL ROOM

- 28 Beds
- 40 Mattresses
- 46 Bed runners & Accessories
- 52 Bedding & Accessories
- 60 Pillows & Duvets
- 66 Accessories

INSPIRATION AND QUALITY

Our product managers and designers are familiar with current trends and are constantly developing exclusive novelties.
We also continuously optimize our services for you.



WORLDWIDE DELIVERY

No matter where you are, our products will be delivered to you worldwide as soon as possible.

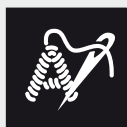

CUSTOMIZING

We are happy to customize your terry or textiles with your logo or the name of your home.

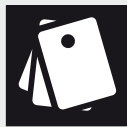

SAMPLE SERVICE

With our sample service, we make your decision easier and give you the opportunity to tailor your product selection to your ambience.

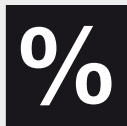

BONUS PROGRAM

We reward your loyalty with the VEGA bonus program.
Just sign up today and start saving immediately!

VEGA is where you are. Contact us by phone, fax or e-mail.

phone +49 8272 807 447 – www.em-group.com

Perfect service

**WE ARE ALWAYS
THERE FOR YOU**

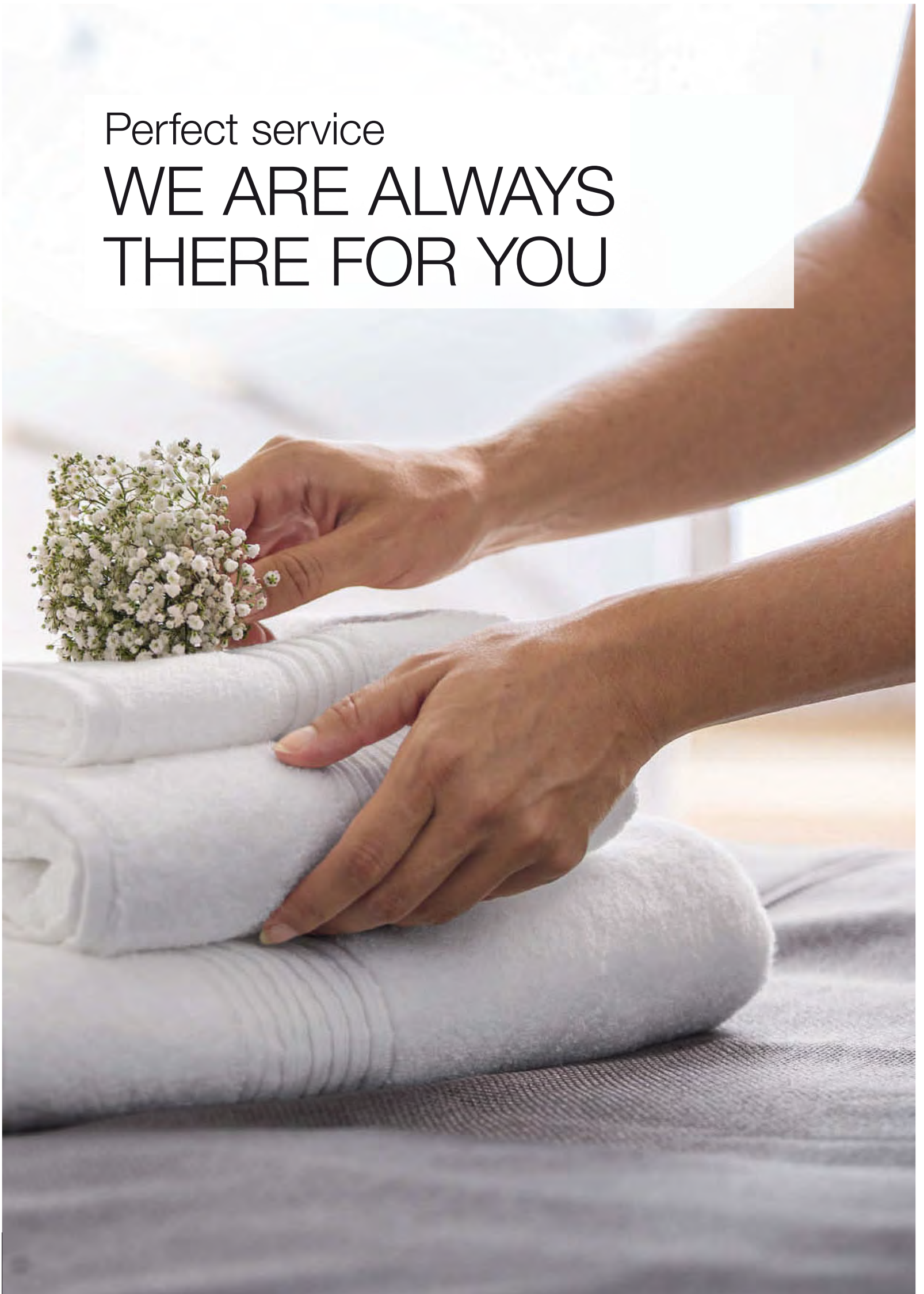

- More content for more luxury
- Paraben free
- With algae extracts (*Laminaria digitata*)

NEW

Shampoo, 50 ml
V-TOUCH SILKY WHITE

064



SILKY WHITE

- Exclusive design
- Vitalizing and stimulating
- Dermatologically tested

During their stay at your hotel your guests want to have something very special. Not only ambience and comfort, but also the small, fine details make your hotel stand out from the crowd. An exclusive care series like SILKY WHITE for example. With this bath and shower gel, shampoo, body lotion and soap, the hotel bath becomes a wellness oasis. The vitalizing and stimulating algae extracts (*Laminaria digitata*) ensure that your guests feel comfortable. The exceptional design is inspired by a vintage medicine bottle. Paraben free. Dermatologically tested.



Shampoo
50 ml
Ref. 10025173
138,24 €/pack of 216
0,64 €/Pc.



Bath/Shower gel
50 ml
Ref. 10025172
138,24 €/pack of 216
0,64 €/Pc.



Body lotion
50 ml
Ref. 10025174
144,72 €/pack of 216
0,67 €/Pc.



Mild soap
20 g
Ref. 10025175
96,- €/pack of 400
0,24 €/Pc.

An exquisite fragrance composition
in timelessly elegant design.



More information on www.em-group.com

 Silky White





Mild soap 20 g
GREEN TEA
021

- Made in Europe
- Paraben free



Care series GREEN TEA

The extracts of green tea, which are one key ingredient of this care series, promise the body a pleasant relaxation and lets the mind rest in clarity. The high-quality, purist design of this series underlines this demand.

Dermatologically tested! With extracts of green tea!

Fragrance: Lemon, anise, bergamot, white musk.

GREEN TEA	Ref.	Pcs./pack	Pack €	=Pc. €
1 Shampoo (for hair and body), 45 ml	10050053	216	79,92	0,37
2 Bath/Shower gel, 45 ml	10050054	216	79,92	0,37
3 Body lotion, 45 ml	10050055	216	84,24	0,39
4 Mild soap in carton, 20 g	10029768	240	50,40	0,21
5 Wooden tray, 21,5x11x2 cm	10059835	1	–	5,29

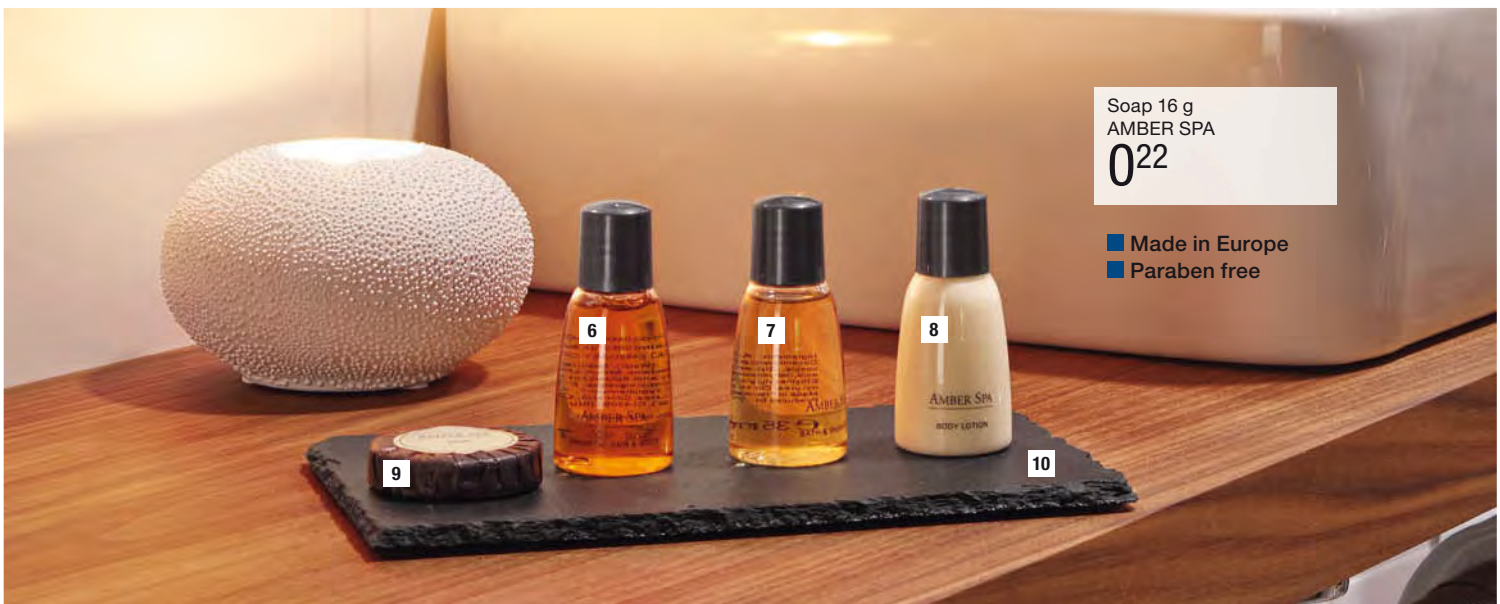

Soap 16 g
AMBER SPA
022

- Made in Europe
- Paraben free



Care series AMBER SPA

Pamper your guests with a charming composition that will go beyond the known senses. AMBER SPA enchants with a fine scent mixture and selected ingredients. A simple and timeless design that combines a clear design with classic grace.

Dermatologically tested!

Fragrance: Peach, raspberry, vanilla, lemongrass, white musk.

AMBER SPA	Ref.	Pcs./pack	Pack €	=Pc. €
6 Shampoo (for hair and body), 35 ml	10059903	128	48,64	0,38
7 Bath/Shower gel, 35 ml	10059902	128	48,64	0,38
8 Body lotion, 35 ml	10059904	128	51,20	0,40
9 Soap pleated, 16 g	10059905	400	88,–	0,22
10 Natural slate platter black, 22x13x0,5 cm	10049616	2	17,98	8,99





Mild soap 16g
V-TOUCH NATURE
020



Care series V-TOUCH NATURE

Smell, feel, touch - the care series V-TOUCH-NATURE gives your guests sensual experiences. Olive oil, extracts of rosemary, orange blossoms and white nettle - the herbal extracts included in this series will pamper and relax your guests. And with the wooden tray made of beech wood, you can put your cosmetics into the limelight.

Dermatologically tested! Enriched with herbal extracts!

Fragrance: Rosemary, orange blossoms, white nettle, anise, white musk.

V-TOUCH NATURE	Ref.	Pcs./pack	Pack €	=Pc. €
11 Shampoo (for hair and body), 40 ml	10029025	216	73,44	0,34
12 Bath/Shower gel, 40 ml	10029024	216	73,44	0,34
13 Body lotion, 40 ml	10029026	216	79,92	0,37
14 Mild soap with olive oil, pleated, 16 g	10059397	400	80,-	0,20
15 Wooden tray ARAWA, LxWxH 20x12x3,3 cm	10029351	1	-	8,99

- Made in Europe
- Paraben free
- With high-quality herbal extracts



11 12 13 14



Wooden tray
ARAWA
8,99

- Made in Europe
- Paraben free
- Dermatologically tested



16 17 18 19



Care series V-TOUCH TENDERGREEN

The extraordinary packaging in fresh green and white tones underlines the naturalness of the series. The convenient screw cap is resealable and allows easy and targeted removal of the content. In addition, these practical pouches are 68% more environmentally friendly than conventional hotel cosmetics.

Fragrance: Shampoo & shower gel: Mint, citrus fruits, bergamot, sandalwood, musk.

Body lotion: Citrus fruits, lavender, roses, basil.

Soap: Mint, lime, bergamot, lavender, white musk, camphor.

V-TOUCH TENDERGREEN	Ref.	Pcs./pack	Pack €	=Pc. €
16 Shampoo (for hair and body), 30 ml	10029902	200	52,-	0,26
17 Bath/Shower gel, 30 ml	10029903	200	52,-	0,26
18 Body lotion, 30 ml	10029904	200	58,-	0,29
19 Liquid soap, 30 ml	10029905	200	54,-	0,27

Shampoo 30 ml
V-TOUCH TENDERGREEN
026



5



Please call us at
+49 8272 807 447



Worldwide
delivery



Please visit us at
www.em-group.com



Mild soap 16g
V-TOUCH CLASSIC
015

- Made in Europe
- Paraben free

Care series V-TOUCH CLASSIC

The high-quality presentation with its gold-glossy print and the exquisite fragrance composition make this series a true classic.

Dermatologically tested!

Fragrance: Lemon, orange blossom, algae, rose, cyclamen, magnolia, hyacinth, white musk.



V-TOUCH CLASSIC	Ref.	Pcs./pack	Pack €	=Pc. €
1 Shampoo & shower gel in 1, 45 ml	10029019	240	60,-	0,25
2 Nurturing shampoo, 45 ml	10029020	240	60,-	0,25
3 Bath/Shower gel, 45 ml	10029021	240	60,-	0,25
4 Body lotion, 30 ml	10029022	297	83,16	0,28
5 Mild soap pleated, 16 g, Ø 4,8 cm	10059389	400	60,-	0,15



Mild soap 20g
V-TOUCH MAUVE
014

- Made in Europe
- Paraben free

Care series V-TOUCH MAUVE

With this care series V-TOUCH MAUVE you will not only round off your stylish demands in your guest bathrooms, but also indulge your guests with new senses. With the vitalizing ingredient vitamin C your guests will start every day with a lively freshness.

Dermatologically tested!

Fragrance: Lilies of the valley, cyclamen, lemon, anise, bergamot, white musk.



V-TOUCH MAUVE	Ref.	Pcs./pack	Pack €	=Pc. €
6 Shampoo (for hair and body), 30 ml	10030198	240	57,60	0,24
7 Bath/Shower gel, 30 ml	10030197	240	57,60	0,24
8 Body lotion, 30 ml	10030199	240	62,40	0,26
9 Mild soap in carton, 20 g	10027907	420	58,80	0,14
10 Natural slate platter Ø 15 cm, H 0,5 cm	10049613	2	15,38	7,69



Bath/Shower gel 30 ml
V-TOUCH CONCEPT

025



Care series V-TOUCH CONCEPT

This care series in a timeless, modern design is not only a visual upgrade for every bathroom. It also convinces with its exquisite ingredients: Bath and shower gel with stimulating extracts of rosemary. The shampoo contains sesame oil and the body lotion contains extracts of the orange blossom.

Dermatologically tested! Enriched with herbal extracts!

Fragrance: Lemon, orange, mint, jasmine.

- Made in Europe
- Paraben free

V-TOUCH CONCEPT	Ref.	Pcs./pack	Pack €	=Pc. €
11 Nuturing shampoo, 30 ml	10059404	330	82,50	0,25
12 Bath/Shower gel, 30 ml	10059405	330	82,50	0,25
13 Body lotion, 30 ml	10059406	330	89,10	0,27
14 Mild soap, 15 g	10029826	480	72,-	0,15
15 Wooden tray, WxDxH 15,5x5x2 cm	10059413	10	34,90	3,49



Mild soap 15g
V-TOUCH CONCEPT

015



The exclusive something:

Customized hotel cosmetic



- Large selection
- Combination possibility of different shapes, sizes, caps and colors in a timeless design
- Digital logo preview on item
- Dermatologically tested

Give your products a personal touch and differentiate yourself from the competitors!

www.em-group.com



■ Made in Europe
■ Paraben free

Mild soap 20g
CRISTALYN
022

> Perfume bottles see page 27.

Care series CRISTALYN

With this care series your guests can see how much emphasis you put on quality from A-Z. The attractive care series CRISTALYN keeps the promises made by its look, but also through its exclusive and modern discreet design. The fresh scent of the dermatologically tested body care products underline the pure, high-grade impression as well.

Dermatologically tested!

Fragrance: Mint, lime, bergamot, lavender, white musk, camphor, geranium.

CRISTALYN	Ref.	Pcs./pack	Pack €	=Pc. €
1 Shampoo (for hair and body), 35 ml	10029790	200	74,-	0,37
2 Bath/Shower gel, 35 ml	10029789	200	74,-	0,37
3 Body lotion, 35 ml	10029791	200	80,-	0,40
4 Mild soap in carton, 20 g	10029792	240	52,80	0,22
5 Tray, made of frosted acrylic, 26x10x2,1 cm	10094411	2	14,18	7,09



Mild soap 20g
V-TOUCH PAINTSPLASH
015

■ Made in Europe
■ Paraben free



Care series V-TOUCH PAINTSPLASH

Wow, what a trendy cosmetic series for your guests: Let yourself be inspired not only by the young, fresh design in shiny metallic colors, but also by the practical flip-top cap. Enriched with vitamin extracts of green tea and seaweed these small power packages are moisturizing. A true experience for your guests.

Dermatologically tested!

Fragrance: Shampoo + body lotion: Lemon, vanilla, lily, jasmine, musk.

Shower gel + soap: Lemon, bergamot, rose, violet, jasmine tea, musk.

V-TOUCH PAINTSPLASH	Ref.	Pcs./pack	Pack €	=Pc. €
6 Shampoo (for hair and body), 35 ml	10029342	200	78,-	0,39
7 Bath/Shower gel, 35 ml	10029343	200	78,-	0,39
8 Body lotion, 35 ml	10029344	200	84,-	0,42
9 Mild soap in foil, 20 g	10029345	350	52,50	0,15



Mild soap 12g
CALA
010

- Made in Europe
- Paraben free

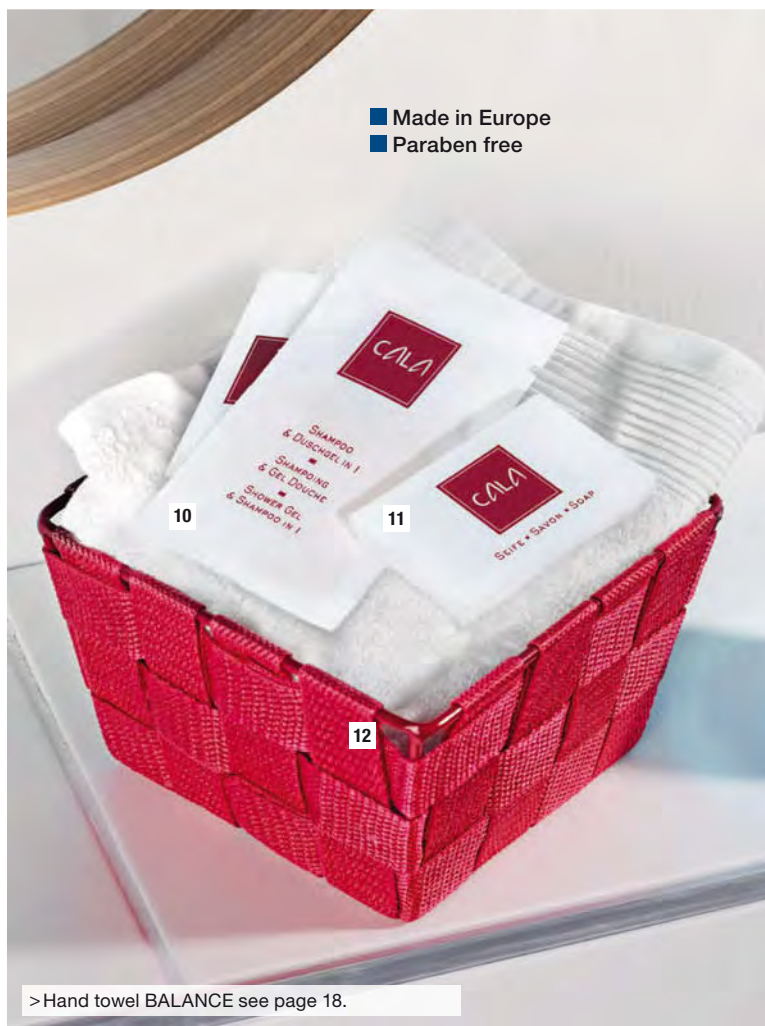

Care series CALA

Unscented, practical in use and unbeatably low-priced - with the care series CALA you are always right on track.

Dermatologically tested!

Fragrance: Shampoo & shower gel: Vanilla.

Mild soap: Lemon, orange blossom, algae, white musk, magnolia.

CALA	Ref.	Pcs./pack	Pack €	=Pc. €
10 Shampoo & shower gel in 1 in sachet, 10 ml	20090909	1000	90,-	0,09
11 Mild soap in paper, 12 g	30000405	500	50,-	0,10
12 Basket STREET red, 14x14x9 cm	10053112	1	-	3,99

> Hand towel BALANCE see page 18.

- Made in Europe
- Paraben free



Mild soap 15g
FONTANA, from
013

Care series FONTANA

The fresh scent and the vitalizing effect make FONTANA a real all-round care series for him and her.

Dermatologically tested!

Fragrance: Shampoo & shower gel: Citrus fruits, orange blossom, mint, rose, musk. Soap: Lemon, orange, algae, magnolia, musk.

FONTANA	Ref.	Pcs./pack	Pack €	=Pc. €
13 Shampoo & shower gel in 1, 20 ml	10059417	300	63,-	0,21
14 Refill bottle shampoo & shower gel in 1, 1 l	10029834	12	34,68	2,89
15 Refill bottle mild liquid soap, 1 l	10029835	12	34,68	2,89
Refill canister mild liquid soap, 5 l	10029836	1	-	11,79
16 Mild soap in foil, 15 g	10022932	480	62,40	0,13
17 Mild soap in carton, 15 g	30003921	420	58,80	0,14



Soap pump dispenser 300 ml
V-TOUCH
3,59

■ Made in Europe
■ Paraben free



Dispenser system V-TOUCH

With these practical dispensers in combination with the pump dispensers you do not only complete wellness or nursing areas, but also wet areas and toilets in the restaurant. The holder always stays on the wall and you only replace the bottles. Please note that the holders of the dispensers must be ordered separately. The assembly is easy. Instructions, keys and mounting material are included.

Series COSMIC and MINERAL: Soap based on passion and cornflower with a soothing and decongestant effect.

Shampoo made of rice and oat extract, rich in vitamin E for a protective and soothing effect.

Series SILVER: Soap made of aloe vera with a soothing effect.

Shampoo with antioxidant extracts of black tea.

V-TOUCH	Content in ml	Ref.	Pcs./pack	Pack €	=Pc. €
COSMIC					
1 Soap pump dispenser	300 ml	10095463	24	86,16	3,59
2 Shampoo dispenser (for hair and body)	330 ml	10095456	24	86,16	3,59
3 Soap dispenser	330 ml	10095457	24	86,16	3,59
MINERAL					
4 Soap pump dispenser	300 ml	10095464	24	86,16	3,59
5 Shampoo dispenser (for hair and body)	330 ml	10095458	24	86,16	3,59
6 Soap dispenser	330 ml	10095459	24	86,16	3,59
SILVER					
7 Soap pump dispenser	300 ml	10095465	24	86,16	3,59
8 Shampoo dispenser (for hair and body)	330 ml	10095460	24	86,16	3,59
9 Soap dispenser	330 ml	10095461	24	86,16	3,59



Plastic holder, from
3,99



Plastic holders for dispenser system

The holder always remains on the wall and you only exchange the dispenser bottle. The assembly is simple. Instructions, key and mounting material are included.

LxDxH: 7x8x22 cm.

Plastic holder	Ref.	Pcs./pack	Pack €	=Pc. €
10 white	10027223	20	79,80	3,99
11 transparent	10095466	20	79,80	3,99
12 silver metallic matt	10027222	20	137,80	6,89

i **PRODUCT INFO**

- 1- Easy assembly!
- 2- Easy replacement of the bottles!
- 3- Thanks to sight strips you always know about the current fill level!





Comb
V-TOUCH
035

>Care series V-TOUCH MAUVE see page 10.
>Wooden tray ARAWA see page 9.



Accessories series V-TOUCH

The whole range of practical cosmetics and small pampering products, which complement and round off the comfort of your guests perfectly. With its timelessly plain packaging, the V-TOUCH accessories series can be combined with all VEGA cosmetics series. It's always a good choice.

V-TOUCH	Ref.	Pcs./pack	Pack €	=Pc. €
13 Comb, 14 cm	10029003	250	87,50	0,35
14 Shower cap	10029004	250	50,-	0,20
15 Shaving set	10029002	50	40,50	0,81
16 Sewing kit	10029013	250	50,-	0,20
17 Shoe polish sponge, 5x3,5x2 cm	10029011	250	60,-	0,24
18 Shoehorn	10059923	100	30,-	0,30
19 Nail file, 8 cm	10029007	250	47,50	0,19

V-TOUCH	Ref.	Pcs./pack	Pack €	=Pc. €
20 Cotton buds, 4 pieces	10095462	250	47,50	0,19
21 Cotton pads, 2 pieces	10029005	250	72,50	0,29
22 Dental kit, 10 g	10029000	100	81,-	0,81
23 Toothbrush tumbler, ØxH 7x8,5 cm, single foiled, 0,2 l	10029001	800	128,-	0,16

Terry



Terry series ATHEN

Made of two-ply terry in a very good quality: Durable, absorbent and with a great terry effect. The bath mat has an all-round edging.

Material: 100% cotton. 95 °C washable, chlorine-resistant.
Weight approx. 380 g/m², bath mat approx. 600 g/m².

ATHEN cm	Hand towel 50x100	Bath towel 70x140	Beach towel 100x150
1 white	10061825	10061833	10061834
2 yellow	10088800	10088801	10088802
3 peach	10061960	10061961	10061995
4 mint green	10088807	10088808	10088809
5 blue	10088345	10088346	10088347
6 NEW taupe	30002191	30002188	30002211
7 NEW grey	30002190	30002200	30002189
€	Pack of 10 24,90	Pc. 4,99	Pc. 8,99
ATHEN cm	Guest towel 30x50	Face towel 30x30	Bath mat 50x70
1 white	10061932	10061837	10061836
2 yellow	10088805	10088804	10088803
3 peach	10062084	10062083	10061996
4 mint green	10085899	10088811	10088810
5 blue	10088350	10088349	10088348
6 NEW taupe	30002182	30002192	30002202
7 NEW grey	30002209	30002199	30002187
€	Pack of 5 7,45	Pack of 5 6,45	Pc. 3,99



Terry series MARS

Robust plain single-ply terry at a super budget price. Absorbent, hard-wearing fabric in the latest colors. In one pack, all parts have the same color.

Material: 100% cotton. 95 °C washable, chlorine-resistant.
Weight approx. 400 g/m², bath mat approx. 600 g/m².

MARS cm	Hand towel 50x100	Bath towel 70x140	Beach towel 100x150
8 white	10072045	10072046	10033608
9 yellow	10072053	10072054	10033615
10 light brown	10072049	10072050	10033614
11 lobster	10072069	10072070	10033612
12 lavender	10072065	10072066	10033611
13 green	10072041	10072042	10033613
14 blue	10072061	10072062	10033610
€	Pack of 10 29,90	Pc. 4,99	Pc. 8,99
MARS cm	Guest towel 30x50	Face towel 30x30	Bath mat 50x70
8 white	10033616	10033624	10072047
9 yellow	10033623	10033631	10072055
10 light brown	10033622	10033630	10072051
11 lobster	10033620	10033628	10072071
12 lavender	10033619	10033627	10072067
13 green	10033621	10033629	10072043
14 blue	10033618	10033626	10072063
€	Pack of 5 7,45	Pack of 5 6,45	Pack of 5 19,95



Individual embroidery

The detail that makes the difference:
 Customized terry - differentiate yourself from the competitors and give your guests something very special.

- Low quantities
- Extensive color selection
- Selection of different fonts

We are happy to assist **+49 8272 807 447**



Hand towel
VALENCIA
4.99

■ New models
■ New colors

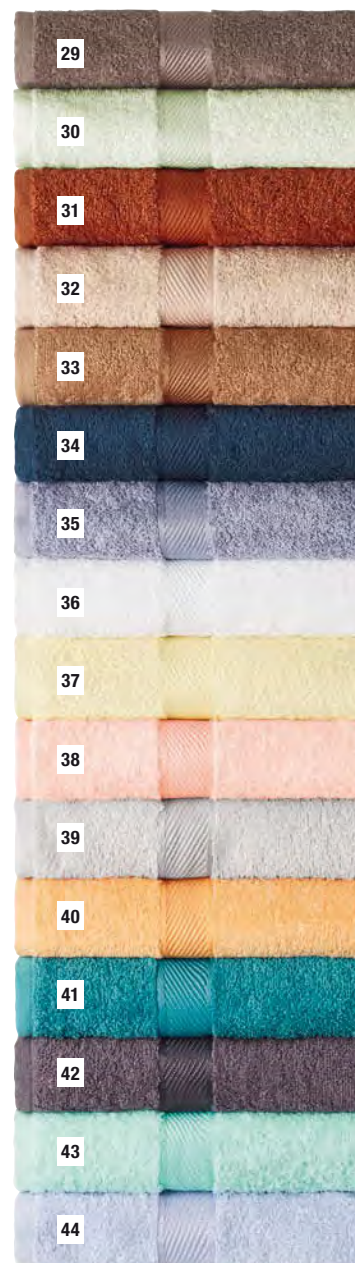

Terry series VALENCIA

Extremely durable top quality in new terry weaving technique. The terry remains dimensionally stable after washing, no deformation of the edging! It is excellent to combine, extremely absorbent, cuddly soft, easy-care, colorfast, boil-proof and chlorine-resistant.

Material: 100% cotton. 95 °C washable, chlorine-resistant (except brown, granite and atlantic blue. 60 °C washable, do not chlorinate). Weight approx. 460 g/m², bath mat approx. 820 g/m².

NEW VALENCIA stripes cm	Hand towel 50x100	Bath towel 70x140
15 brown / white	10001510	10001511
16 pea green / white	10052538	10052539
17 rusty red / white	10053623	10053624
18 beige / white	10053629	10053630
19 nougat / white	10053635	10053636
20 pigeon blue / white	10054296	10054297
21 yellow / white	10062022	10062023
22 peach / white	10067231	10067224
23 stone grey / white	10067244	10067245
24 granite grey / white	10067251	10067236
25 amber / white	10067257	10067258
26 petrol / white	10067299	10067484
27 mint green / white	10067599	10067281
28 light blue / white	10067669	10067372
€	Pc. 4,99	Pc. 8,99

VALENCIA plain cm	Hand towel 50x100	Bath towel 70x140	Beach towel 100x150	Guest towel 30x50	Face towel 30x30	Bath mat 50x90
29 brown	10001504	10001505	10001506	10001507	10001508	10001509
30 pea green	10052544	10052545	10052546	10005057	10052548	10052550
31 rusty red	10053639	10053642	10053643	10005061	10053645	10053659
32 beige	10053647	10053648	10053649	10005052	10053651	10053660
33 nougat	10053653	10053654	10053655	10005059	10053657	10053661
34 atlantic blue	10054289	10054290	10054291	10005051	10054293	10054295
35 pigeon blue	10054302	10054303	10054304	10005063	10054306	10054308
36 white	10060259	10060318	10051781	10005064	10051800	10067800
37 yellow	10060279	10060329	10051782	10005055	10051801	10062046
38 peach	10060286	10060332	10051783	10005050	10051802	10067216
39 stone grey	10060301	10060369	10051789	10005062	10051808	10067250
40 amber	10060304	10060373	10051784	10005053	10051803	10067265
41 NEW petrol	10060310	10060396	10051788	10005060	10051807	10067328
42 granite	10067238	10067220	10051790	10005056	10051809	10067757
43 mint green	10067519	10067520	10051787	10005058	10051806	10067606
44 light blue	10067607	10067637	10051786	10005054	10051805	10067693
€	Pc. 4,99	Pc. 8,99	Pc. 14,99	Pack of 5 14,95	Pack of 5 12,95	Pc. 6,99



Please call us at
+49 8272 807 447



Worldwide
delivery



Please visit us at
www.em-group.com

Terry



Terry series BALANCE

This terry turns any bathroom into an oasis of relaxation. The towels with a silky gloss, velvety grip and flowing drape are pure luxury for your guest. The soft, fluffy fabric contains viscose, which is extracted from bamboo fibers. The towels are provided with a woven structure in a pleated look.

Material: 60% cotton, 40% viscose. 95 °C washable. Intensive colors (cherry, anthracite, night blue): 60 °C washable, do not chlorinate. Weight approx. 600 g/m². Bath mat approx. 800 g/m².

BALANCE cm	Hand towel 50x100	Bath towel 70x140	Beach towel 100x150	Spa towel 70x200
1 white	10038458	10038459	10038460	10064828
2 silk	10038425	10038426	10038427	10064825
3 cherry	10038403	10038404	10038405	10067712
4 ivory	10038414	10038415	10038416	10064829
5 purple	10038392	10038393	10038394	10067710
6 azure	10056740	10056741	10056742	10067711
7 lime	10038381	10038382	10038383	10085838
8 bamboo	10019221	10019222	10019223	10064827
9 night blue	10001454	10001455	10001456	10001457
10 mud	10038436	10038437	10038438	10064824
11 anthracite	10019209	10019210	10019211	10067713
€	Pc. 6,99	Pc. 12,99	Pc. 18,99	Pc. 18,99

BALANCE cm	Guest towel 30x50	Face towel 30x30	Bath mat 60x60
1 white	10005018	10005017	10038463
2 silk	10005028	10005016	10038430
3 cherry	10005022	10005010	10038408
4 ivory	10005023	10005011	10038419
5 purple	10005026	10005014	10038397
6 azure	10005020	10005008	10056745
7 lime	10005024	10005012	10038386
8 bamboo	10005021	10005009	10019226
9 night blue	10001458	10001459	10001460
10 mud	10005027	10005015	10038441
11 anthracite	10005019	10005007	10019214
€	Pack of 5 19,95	Pack of 5 14,95	Pc. 7,99



Terry series LAGUNA

The delicately structured single-ply terry series gives a feeling of well-being in a very natural way and lets your guests enjoy their stay to the fullest. The front is equipped with river pebble structure, the back with absorbent terry surface.

Material: 100% cotton, 95 °C washable, chlorine-resistant (dark grey 60 °C washable, do not chlorinate). Weight approx. 500 g/m², bath mat approx. 750 g/m².

LAGUNA cm	Hand towel 50x100	Bath towel 70x140	Beach towel 100x150
12 beige	10068347	10068348	10068422
13 white	10068981	10068982	10069426
14 turquoise	10068451	10068832	10068833
15 dark grey	10069430	10069431	10069432
16 grey	10068431	10068432	10068433
Pc. €	7,99	14,99	19,99

LAGUNA cm	Spa towel 70x200	Spa towel 100x200	Bath mat 70x70
12 beige	10087603	10068423	10068424
13 white	10087605	10069427	10069428
14 turquoise	10087604	10068834	10068980
15 dark grey	10087607	10069442	10069443
16 grey	10087606	10068449	10068450
Pc. €	19,99	26,99	9,99



Individual embroidery



Customized terry - differentiate yourself from the competitors and offer your guests something very special.

www.em-group.com

■ New colors



Terry series BERMUDA

High-quality, cotton-soft single-ply terry. The volume, the beautifully woven edging and the top-current colors give your bathroom an elegant, neat look. Please order the bath mat to complement the towels! Embroidery possible.

Material: 100% cotton. 95 °C washable, chlorine-resistant, intensive colors (atlantic blue, granite grey, burgundy and chocolate) 60 °C washable, do not chlorinate.

Weight approx. 450 g/m², bath mat approx. 600 g/m².

BERMUDA cm	Hand towel 50x100	Bath towel 70x140	Spa towel 70x200	Beach towel 100x150	Guest towel 30x50	Face towel 30x30	Bath mat 50x70
17 NEW linen red	10053593	10053594	10015978	10033550	10053596	10053597	10053595
18 stone grey	10053608	10053612	10015979	10033548	10053614	10053615	10053613
19 amber	10053616	10053618	10015975	10033546	10053620	10053621	10053619
20 atlantic blue	10054334	10054335	10015982	10033554	10054337	10054338	10054336
21 granite grey	10056746	10056747	10015986	10056748	10056749	10056750	10056752
22 white	10061460	10061471	10015971	10033538	10062820	10053447	10061482
23 NEW yellow	10061462	10061474	10015973	10033540	10062822	10053449	10061484
24 emerald green	10061465	10061477	10015981	10033543	10062825	10053452	10061487
25 bleu	10061470	10061472	10015983	10033541	10062823	10053450	10061492
26 chocolate	10074583	10074584	10015989	10074585	10074586	10074587	10074589
27 burgundy	10074590	10074591	10015988	10074592	10074593	10074594	10074596
28 kiwi	10074604	10074605	10015985	10074606	10074607	10074608	10074610
€	Pc. 4,79	Pc. 8,99	Pc. 12,99	Pc. 12,99	Pack of 5 9,95	Pack of 5 8,95	Pc. 4,99



Laundry sticker/stand

With a recommendation for environmentally conscious behavior of your guests in 3 languages (English/German/French). The printed text can be viewed quickly and easily on www.em-group.com.

Laundry sticker	WxH in cm	Ref.	Pcs./pack	Pack €
29 white	16,5x16,5	10053075	10	4,89
Carton laundry stand	WxH in cm	Ref.	Pcs./pack	Pack €
30 white	11,2x15	10053078	10	4,79





Terry series CLASSICO

Single-ply terry towels in heavy, premium quality, absorbent and cotton-soft touch.

Material: 100% cotton. 95 °C washable, chlorine-resistant.
Weight approx. 450 g/m², bath mat approx. 700 g/m².

CLASSICO	LxW in cm	Ref.	Pcs./pack	Pack €	=Pc. €
1 Hand towel	50x100	10087169	10	39,90	3,99
Bath towel	70x140	10087170	5	34,95	6,99
Beach towel	100x150	10087165	5	54,95	10,99
2 Guest towel	30x50	10087166	5	9,95	1,99
Face towel	30x30	10087168	5	8,95	1,79
3 Bath mat	50x70	10000811	10	49,90	4,99



Terry series EASY

2-ply terry towels in premium quality and durable quality, absorbent and cotton-soft touch. Dimensionally stable, double seams. Embroidery possible.

Material: 100% cotton. 95 °C washable, chlorine-resistant.
Weight approx. 600 g/m². Bath mat approx. 800 g/m².

EASY	LxW in cm	Ref.	Pcs./pack	Pack €	=Pc. €
4 Hand towel	50x100	10087171	1	–	5,99
Bath towel	70x140	10087172	1	–	11,99
5 Beach towel	100x150	10087173	1	–	17,99
Guest towel	30x50	10087176	5	16,95	3,39
6 Bath mat	50x80	10087175	1	–	6,99



Terry slippers

Pure white terry is the epitome of comfort and freshness. The disposable slippers always fit and have an extra strong padded heel and a slip-resistant sole. The textile nubbed sole is also equipped with an incorporated moisture brake.

Material: 100% cotton with polyethylene sole.

Terry slippers	Ref.	Pairs/pack	Pack €	=Pair €
Universal size				
7 open front, 75 g	10027497	10	16,90	1,69
open front, 75 g	10027498	100	164,–	1,64
8 closed front, 85 g	10030055	10	17,90	1,79
closed front, 85 g	10030056	100	174,–	1,74



Laundry bags

Indispensable in every well-run hotel: Extremely durable and long-lasting laundry bags. You have the choice between the pack of 10 or the cost-saving pack of 50.

Material: 100% cotton, 95 °C washable. Weight approx. 140 g. Embroidery possible on request!

Laundry bags	Ref.	Ref.
9 40 x 60 cm	10016349	10016350
Pcs./pack	10	50
Pack €	19,90	95,–
Pc. €	1,99	1,90

Bathrobe
ADRIA, from
18⁹⁹



Bathrobes ADRIA

Single-ply terry bathrobe as kimono, with shawl collar or with hood in white. Best workmanship, comfortable, wide cut, with two patch pockets and belt. Suitable for "him" and "her"! Length at size S/M: 125 cm.

Material: 100% cotton. 95 °C washable, chlorine-resistant. Weight approx. 360 g/m².

ADRIA	Size			Pc. €
	S/M	L/XL	XXL	
10 Kimono	10001418	10001419	10086186	18,99
11 Shawl collar	10001420	10001421	10087162	19,99
12 Hood	10001422	10001423	10086191	19,99



Bathrobe
PURES
39⁹⁹



Bathrobe
MOTION
39⁹⁹



Bathrobe PURES

Luxurious bathrobe for him & her with shawl collar, soft velor outside and absorbent single-ply terry inside. The blended fabric lets the bathrobe dry quickly and pampers your guests with a comfortable fit. Give the bathrobe a special touch by embroidering your logo. We are happy to assist. Length at size S/M: 125 cm.

Material: 50% cotton, 50% polyester, 95 °C washable, chlorine-resistant. Weight approx. 350 g/m².

PURES			
Size	S/M	L/XL	XXL
13 white	10001632	10001692	10001656
Pc. €	39,99	39,99	39,99



Bathrobe MOTION

High-quality, fluffy-soft and absorbent single-ply terry. Noble, elegant and in exquisite durable quality that is appropriate to the extreme demands of the hotel industry. Embroidery possible. Length at size S/M: 125 cm.

Material: 59% cotton, 41% rayon. 95 °C washable, chlorine-resistant. Weight approx. 400 g/m².

MOTION			
Size	S/M	L/XL	XXL
14 white	10001450	10001451	10088148
Pc. €	39,99	39,99	39,99



Towel hook
BROOKLYN
9.99



1 Towel hook



2 Soap dish standard



3 Soap dish angle mounting



4 Tissue box



6, 7 Hygiene bag dispenser
8 Hygiene bag



9 WC set

Towel holder with storage shelf
BROOKLYN
79.99



10 Towel holder with storage shelf

18/10 18/8

6, 7 9

Bath accessories BROOKLYN

Delivery includes mounting material.

Material: Chromed brass, fig. 9 made of brushed chrome-nickel stainless steel 18/8 and fig. 6 + 7 made of chrome-nickel stainless steel 18/10.

BROOKLYN	WxDxH/ØxH in cm	Ref.	Pcs./ pack	Pack €	Pc. €
1 Towel hook	2,6x5,2	10077598	1	-	9,99
2 Soap dish standard	12,5x9,5x2,8	10077785	1	-	16,99
3 Soap dish angle mounting	15,2x12,1x3	10077682	1	-	18,99
4 Tissue box	27,1x5,3x14,8	10077433	1	-	22,99
5 Tissues 2-ply	20x20	10029237	4000	47,99	-
6 Hygiene bag dispenser glossy	8,8x2,6x13,5	10079188	1	-	13,99
7 Hygiene bag dispenser matt	8,8x2,6x13,5	10079177	1	-	13,99
8 Hygiene bags	7,8x2,1x12,5	10059379	25	2,09	-
9 WC set	9x40	10055002	1	-	11,79
Spare brush	8x9	10055003	1	-	3,49
10 Towel holder with storage shelf	60x25x7,5	10077654	1	-	79,99



Towels see pages 16-20
and on

www.em-group.com



11 Soap dispenser



12 Toothbrush tumbler

Soap tray
HUDSON
18⁹⁹



13 Soap dish



14 WC set



15 Toilet paper holder with lid



16 Toilet paper spare roll holder



Towel hook
HUDSON
9⁴⁹

■ Brushed stainless steel

17 Towel hook



18 Towel rail single



19 Towel rail double



20 Glass shelf



Soap dispenser
HUDSON
20⁹⁹

Towel rail double
HUDSON
33⁹⁹

> Hand towel BERMUDA see page 19.

18/8

Bath accessories HUDSON

This wall series is made of high-quality, matt stainless steel. The soap dish, soap dispenser, toothbrush tumbler and WC set are supplied with removable plastic containers. Delivery includes mounting material.

Material: Stainless steel, polypropylene (fig. 14) and acrylic (fig. 11 - 13).

HUDSON		WxDxH in cm	Ref.	Pc. €
11	Soap dispenser, 250 ml	7x11x18	10053115	20,99
12	Toothbrush tumbler	17,5x9x9,5	10053117	23,99
13	Soap dish	11x13x5,5	10053114	18,99
14	WC set	10x14x35	10053027	25,99
	Spare brush without handle	-	10053028	6,99
15	Toilet paper holder with lid	15x7x13,5	10053131	20,99
16	Toilet paper spare roll holder suitable for 2 rolls	8x12,5x18	10053134	16,99
17	Towel hook	5,5x5,5	10053113	9,49
18	Towel rail single	60x7x5,5	10053121	29,99
19	Towel rail double	60x14x5,5	10053122	33,99
20	Glass shelf	46,5x13,5x5,5	10053119	33,99



Please call us at
+49 8272 807 447



Worldwide
delivery



Please visit us at
www.em-group.com



NEW

Wall changing table
PINE
179⁰⁰

■ Foldable



Wall changing table PINE

Space-saving, sturdy changing system made of metal, including storage shelf. Foldable and openable with one hand. In the closed state splash-proof. Changing area 65x75 cm. Max. load capacity 40 kg. For easy installation on solid walls - instructions enclosed. Delivery without utensils and mounting material. Please order changing mat separately.

Material: Metal.

Wall changing table: WxDxH 67x16,5x76,5 cm.

Weight: 15,5 kg.

Changing mat: LxWxH 64x74x1,5 cm.

		Ref.	Pc. €
1	Wall changing table PINE	20090771	179,-
2	Changing mat CEDAR	20090772	19,99

Waste bin
14⁹⁹



Waste bin with
stainless steel ring
20⁹⁹



Waste bin
7⁹⁹



Waste bin

Made of stainless steel. With removable insert made of plastic. Not fireproof.

Waste bin	Content in l	ØxH in cm	Ref.	Pc. €
3 silver	8 l / insert 5 l	20,6x27	10006090	14,99

Waste bins with stainless steel ring

Noble waste bin made of sturdy ABS plastic and solid stainless steel ring. Not fireproof.

Waste bin	Content in l	ØxH in cm	Ref.	Pc. €
4 black	6,4	19,4x25	10029481	20,99
5 grey	6,4	19,4x25	10029806	20,99

Waste bin

Oval, made of plastic. Not fireproof.

Waste bin	Content in l	WxDxH in cm	Ref.	Pc. €
6 white	6,5	24,1x19,2x25	10055026	7,99



Pedal bin from
12⁴⁹



18/0

9, 10

Pedal bins

Made of powder-coated steel sheet (fig. 7 - 8) or sturdy stainless steel (fig. 9 - 10). The lid closes very quiet and odor-proof. The plastic inner container is removable for easy emptying.

Pedal bin	Ref.	Pc. €
ØxH 17x25,5 cm, content 3 l		
7 white	10053162	12,49
8 black	10059057	12,49
9 silver matt	10059084	12,99
10 silver glossy	10059085	12,99

Trash bags	Content in l	WxH in cm	Ref.	Pc./roll	Roll €
grey	6	29x33	10027955	50	1,19

Toothbrush tumbler
V-TOUCH
016



11

Toothbrush tumbler V-TOUCH

V-TOUCH	ØxH in cm	Ref.	Pcs./ pack	Pack €	=Pc. €
11	200 ml, single foiled	7x8,5	10029001	800	128,- 0,16



12

13

Cosmetic mirrors

The swivelling chrome-plated metal make-up mirror is extendable up to 32 cm. The model is also rotatable - single and 5x magnification - and can be easily attached to the wall with the included mounting material.

Cosmetic mirror	Ø/LxW in cm	Ref.	Pc. €
12 angular	15x15	10022350	23,99
13 round	16	10021966	23,99



Hair dryer

59,99



14



Hair dryer

Made of plastic. Due to its extra-strong, break-proof and hard-wearing material it is perfectly suitable for use in the hotel industry. It's slip-resistant and the ergonomically shaped handle rests well in the hand and the professional motor dries the hair of your guests in minutes. Thus you will save energy and your guests are completely satisfied. The hair dryer has 2 fan levels and 3 heat levels as well as a separate cold air button. It also has a cable for connecting to the power socket and can easily be stored in a drawer. The removable hair filter allows easy cleaning. Easy connection with Euro plug. 2 years warranty.

Several fan and heat levels! With overheat control!

14 Hair dryer	
WxDxH in cm	23,6x9,2x26,1
Connected load	2 kW / 230 V
Weight in kg	0,8
Color	black
Ref.	10008404
Pc. €	59,99



Professional hair dryer

99,99



15

16



Professional hair dryers

A hair dryer in the bathroom is the perfect service for your guests. Thanks to the Tourmaline + Ceramic + Ion technology, this high-quality hair dryer brings more shine and suppleness to the hair of your guests and makes it easier to style. It has an ergonomic handle and a spiral cable, the hair filter can be removed for cleaning. Safety is also important to this hair dryer: It is equipped with a safety button that must be pressed actively to switch on the hair dryer. The hair dryer is stored space-saving in a design wall bracket, on which is also the main switch. 2 years warranty.

Several fan and heat levels! With overheat control!

Professional hair dryer	15 white	16 black
WxDxH in cm	25x9x22	25x9x22
Connected load	1800 kW/230 V	1800 kW/230 V
Weight in kg	0,42	0,42
Max. cable length	0,7 m	0,7 m
Ref.	30014374	30014375
Pc. €	99,99	99,99

Hair dryer

20,99



17



Hair dryer

Indispensable in any bathroom! The hair dryer has a 2 level switch and a theft-proof wall bracket. 2 years warranty.

17 Hair dryer	
WxDxH in cm	17x7x19
WxH in cm (wall bracket)	8,5x9,5
Connected load	1,35 kW/ 230 V
Max. cable length	1,4 m
Weight in kg	0,264
Color	white
Ref.	10080980
Pc. €	20,99

Bath accessories

Paper towel dispenser

56⁹⁹



18/8

Paper towel dispenser

Made of brushed chrome-nickel stainless steel 18/8. Delivery includes key to lock and mounting material, but without paper towels.

Paper towel dispenser	WxDxH in cm	Ref.	Pc. €
1	27,5x13,3x33	20090749	56,99

Jumbo roll dispenser

52⁹⁹



18/8

Jumbo roll dispenser

Made of brushed chrome-nickel stainless steel 18/8. Delivery includes key to lock and mounting material, but without toilet paper.

Jumbo roll dispenser	WxDxH in cm	Ref.	Pc. €
2	30x12x31	20090750	52,99

Hygiene bag dispenser BROOKLYN

13⁹⁹

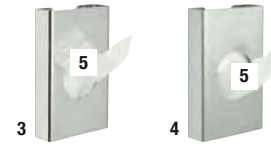

18/10

Hygiene bag dispensers BROOKLYN

Made of stainless steel. The items are delivered including mounting material. Please order the matching hygiene bags at the same time.

Hygiene bag dispenser	LxWxH in cm	Ref.	Pcs./Pack	Pc. €
3 glossy	8x13,5x2,6	10079188	1	13,99
4 matt	8x13,5x2,6	10079177	1	13,99
5 Hygiene bags	7,8x12,5x2,1	10059379	25	2,09

Paper towel dispenser

27⁹⁹



Paper towel dispenser

Made of impact-resistant ABS plastic, for approx. 250 paper towels. With a practical viewing window, so you can immediately see when the paper towels have to be refilled. Delivery with a key for locking and mounting material, but without paper towels.

Paper towel dispenser	WxDxH in cm	Ref.	Pc. €
6 white	30x13,7x30	10053161	27,99

Toilet paper dispenser

24⁹⁹



Toilet paper dispenser

Made of impact-resistant ABS plastic, suitable for 1 roll of toilet paper up to a diameter of 20 cm. With a practical viewing window so that you can see when the roll needs to be replaced. Delivered with a key for locking and mounting material. Please order toilet paper roll separately.

Toilet paper dispenser	WxDxH in cm	Ref.	Pc. €
7 white	22,5x14x27	10053160	24,99

Hygiene bag dispenser

MINTY

3⁹⁹



Hygiene bag dispenser MINTY

Made of sturdy plastic. The item is delivered with mounting material. We also offer the matching hygiene bags.

MINTY	WxDxH in cm	Ref.	Pcs./Pack	Pc. €
8 white	9,5x3,5x13	20090851	1	3,99
9 transparent	8,8x1,4x12,5	10059371	25	2,09

Jumbo toilet paper, from

4⁴⁹



Jumbo toilet papers

Ref. 10029475 suitable for dispenser Ref. 10053160, fig. 7. Ref. 20090743 suitable for dispenser Ref. 20090750, fig. 2.

Jumbo toilet paper	ØxW in cm	Length in meter	Ref.	Pcs./pack	Pack €	=Pc. €
10 1-ply	18,8x10	240	10029475	12	53,88	4,49
11 2-ply	24x10	340	20090743	6	28,14	4,69

Toilet papers

Made of tissue with 250 pieces per roll.

Toilet paper	ØxW in cm	Ref.	Pcs./pack	Pack €	=Pc. €
11 2-ply, white	9,8x12	20090744	64	18,56	0,29
3-ply, white	9,8x12	20090745	48	18,72	0,39

Paper towels pack of 5000

20⁹⁹



Paper towels

Paper towels	LxW in cm	Ref.	Pcs./pack	Pack €
Made of 100% recycled paper (RC), embossed, with zigzag-fold				
12 1-ply, natural	25x23	10059899	5000	20,99
Made of tissue, short piece, with W-fold				
13 2-ply, white	25x23,5	20090196	3045	27,99
Made of tissue, with C-fold				
14 2-ply, white	33x24	10059529	3000	37,99
Made of tissue, with W-fold				
14 3-ply, white	34x23,5	10059533	1890	33,99

Hand dryer

85⁹⁹



15



Hand dryer

Impact-resistant plastic housing for hygienic drying. With infrared-proximity switch for contact-free switching on and automatic shutdown. Mounting material is included. 2 years warranty.

Low noise!

Hand dryer	WxDxH in cm	Ref.	Pc. €
Connected load 1 kW/230 V, volume 72 dB, weight 1,6 kg			
15 white	21x14x29	10081355	85,99



16

Hand dryer

719⁰⁰



Terry towels see pages 16-20 and on

www.em-group.com

Hand dryer

Made of a rustproof aluminum cast. 2 strong air currents in the fan zone with up to 60 km/h allow drying in less than 20 seconds. An integrated sensor enables automatic and contact-free on/off switching. Air flow adjustable. Excess water is collected in a container that can be easily emptied - a light alerts when the container is full. Air filter removable and easy to clean. Rounded shapes without transitional surfaces ensure easy cleaning. Delivered with wall bracket as well as mounting material and a key for locking the hand dryer. 2 years warranty.

Hand dryer	WxDxH in cm	Ref.	Pc. €
Connected load 1,2 kW/230 V, volume 80 dB, weight 7 kg			
16 white/grey	34x23,4x43	10081554	719,-

Air freshener

39⁹⁹



17



18

19

20

21

22

Air freshener

Supplied with mounting material, without batteries (2x 1,5 V LR 20) and without fragrance spray. This air freshener covers 30 m².

On/off switch can be operated externally!
3 activation levels: 24-h, light or dark active, with light sensor!

Air freshener	17
WxDxH in cm	12x9x20,2
Spray interval	5 – 40 min.
Effective period	approx. 30 days
Ref.	10081356
Pc. €	39,99

The following CFC-free fragrance sprays are available for our air freshener Ref. 10081356:

Fragrance spray	Content in ml	Ref.	Pc. €
18 Vanilla	250	10081357	6,99
19 Lemon	250	10081359	6,99
20 Apple	250	10081358	6,99
21 Fresh breeze	250	10081360	6,99
22 Spa	250	10081362	6,99

Perfume bottle, from

10⁴⁹



27

23

24

25

26

Perfume bottles

The right aroma is part of a successful feel-good atmosphere. The fragrance in the small size (100 ml) is enough for 3 months. The large fragrance bottles (200 ml) are enough for 6 months. Delivery includes sticks. These fragrance bottles cover 30 m².

Perfume bottle Content	Ref. 100 ml	Ref. 200 ml
LxWxH in cm	5,5x5,5x10,5	6,8x6,8x10,5
23 Cedar Wood	10089369	10089370
24 Cotton Fields	10049881	10049836
25 Orange Sky	10049883	10049838
26 Lime Light	10049884	10049839
27 Flower Bowl	10049882	10049837
Pc. €	10,49	15,49

- Comfortable
- High-quality
- Complete set

Box spring bed - complete set
Double bed

799⁰⁰

BOX SPRING BED COMPLETE SET

- Bonnell spring box
- Bonnell spring mattress (115 springs per m², cover made of imitation leather 100% polyester, upholstery 100% polyester (280 g/m²))
- Topper with comfort foam filling
- Upholstered headboard made of 100% polyester and cover made of imitation leather 100% polyester
- Round legs made of stained wood, color silver

Sleeping in a healthy and relaxing way is a crucial criteria when it comes to select a suitable hotel. Therefore, the bed is the central and most important furnishing element of your rooms. With our price/performance winner you get a complete box spring bed consisting of Bonnell box, Bonnell mattress, comfort foam topper, a classic straight headboard and legs. Available in 2 colors.

NEW: Now also available with fabric cover - see page 37.

Box spring bed - complete set	Single bed	Double bed
cm	90 x 200	180 x 200
Cover	Imitation leather	Imitation leather
beige	10086727	10086728
dark grey	10086729	10086730
Pc. €	399,-	799,-



A guarantee for the restful sleep of your guests.



More information on www.em-group.com

Box spring bed - complete set

Combine your individual wooden bed

1/ Select bed frame

2 sizes



2/ Select headboard

2 models – 2 sizes



Upholstered headboard – white



Wooden headboard

3/ Complete the wooden headboard with matching headrests



+



Headrest

=



4/ Complete with night console

2 models



Classic look



Floating look

5/ Select the matching mattress

pages 40-43

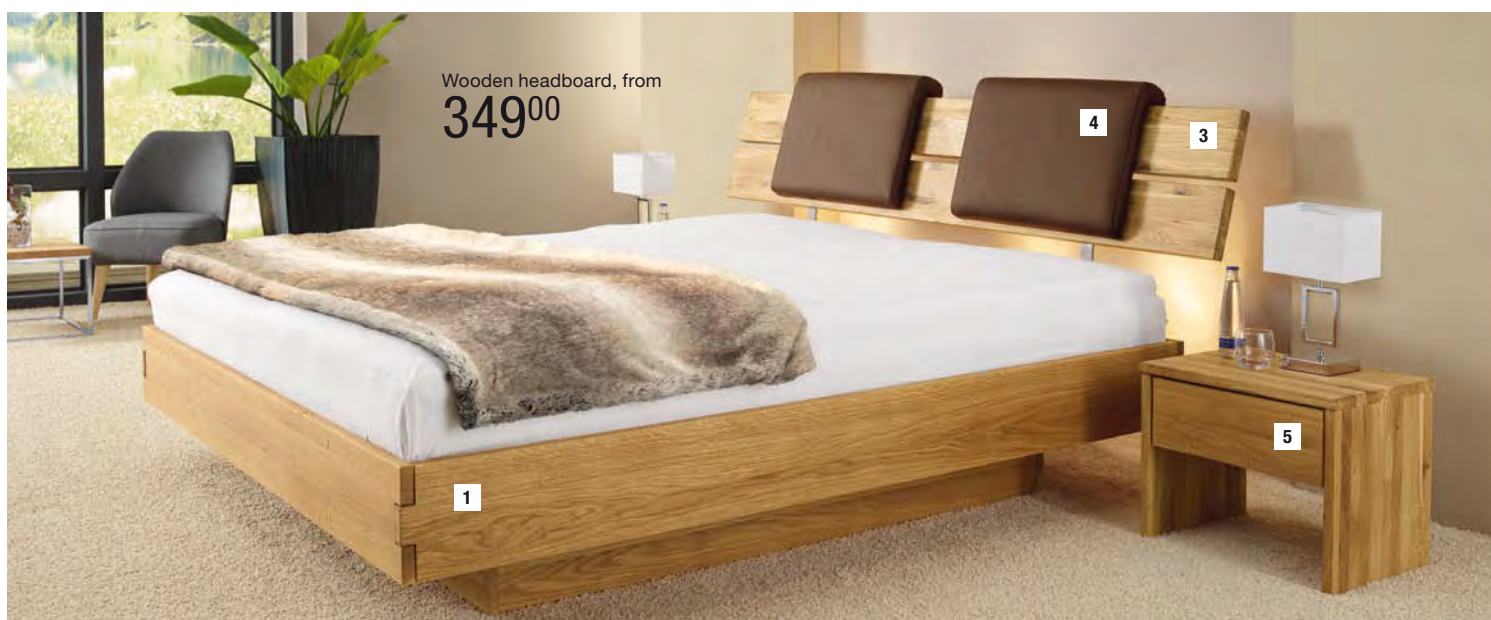
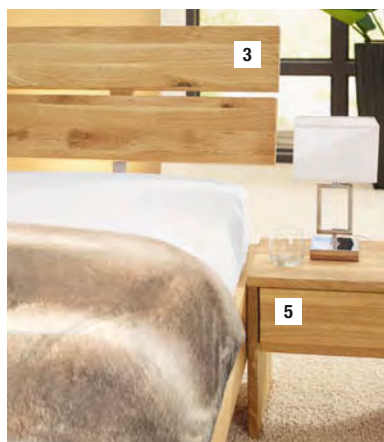

Solid wooden bed

The stylish bed is made of solid, high-quality wild oak. The durable oiled wood needs no special care.

Bed frame:

- Floating, modern look by inwardly offset pedestal

Upholstered headboard:

- Made of high-quality, embossed imitation leather
- Stable processed by internal wooden frame
- Material: 100% polyester

Wooden headboard:

- Slight inclination for increased seat comfort
- Adaptable to the height of the mattress by a rail system

- Material: Solid wild oak

Headrest:

- Made of easy-care, stain-resistant imitation leather

- Material: 100% polyester

Night console:

- Classic look with a drawer

- Floating look with a drawer, attachment to the bed frame necessary (mounting material is included)

- Material: Solid wild oak

Bed frame* cm	146x212x21	206x212x21
1 wild oak	10001846	10001847
Pc. €	999,-	1299,-

*Assembly instructions are included.

Upholstered headboard WxHxD in cm	200x160x16	260x160x16
2 white	10001853	10001856
Pc. €	449,-	549,-

Wooden headboard LxW cm	162x38	222x38
3 wild oak	10001858	10001859
Pc. €	349,-	499,-

Headrest cm	60x43
4 brown	10001861
€	Pack of 2 139,-

Night console classic look, cm	50x40x35
5 wild oak	10001864
Pc. €	199,-

Night console floating look, cm	50x43x37
6 wild oak	10001863
Pc. €	189,-



Please call us at
+49 8272 807 447



Worldwide
delivery



Please visit us at
www.em-group.com



Double bed
XARA DENVER
739⁰⁰

NEW

Adjustable back



Upholstered bed XARA DENVER

The upholstered bed XARA DENVER has a split back with two independently adjustable parts. The box is made of wood and equipped with a rigid wooden slatted frame. You can choose matching legs and mattresses from our range. Legs are sold separately (see fig. 10 - 12). More colors/covers can be found on www.em-group.com.

Height bed frame: 14,5 cm.

Height headboard: 82 cm.

Material: Cover 100% polyester. Weight approx. 330 g/m².

XARA DENVER WxL cm	Single bed 90x200	Double bed 180x200
Weight in kg	31,8	65,7
taupe	30002422	2 30002423
rust	1 30002429	30002420
aqua	30002427	3 30002419
Pc. €	369,-	739,-

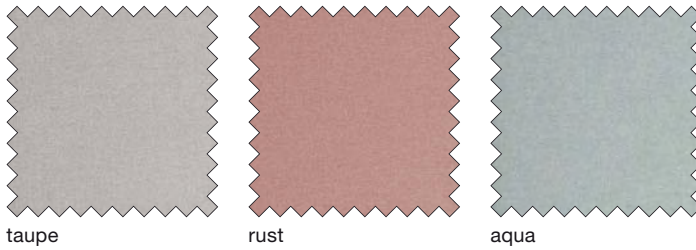

Double bed
IVA DENVER
659⁰⁰

NEW



Upholstered bed IVA DENVER

The back of the upholstered bed IVA DENVER is extra wide padded for an excellent look. The box is made of wood and equipped with a rigid wooden slatted frame. You can choose matching legs and mattresses from our range. Legs are sold separately. More colors/covers can be found on www.em-group.com.

Height bed frame: 14,5 cm.

Height headboard: 74,5 cm.

Material: Cover 100% polyester. Weight approx. 330 g/m².

IVA DENVER WxL cm	Single bed 90x200	Double bed 180x200
Weight in kg	31,5	61
taupe	30002425	5 30002428
rust	30002421	6 30002418
aqua	4 30002435	30002426
Pc. €	329,-	659,-

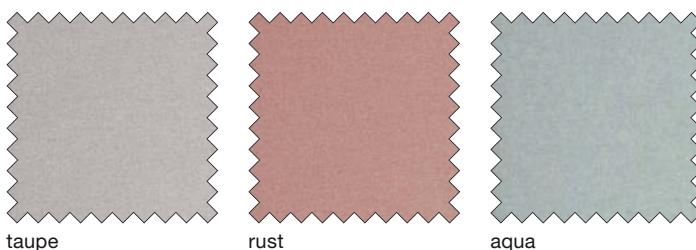

NEW

Double bed
ARYA DENVER
669⁰⁰



> Bed linen EMMEN see page 54.

Single bed
ARYA DENVER

339⁰⁰ ⁷



Upholstered bed ARYA DENVER

The modern upholstered bed ARYA DENVER with its curved back is an eye-catcher in your premises. The box is made of wood and equipped with a rigid wooden slatted frame. You can choose matching legs and mattresses from our range. Legs are sold separately. More colors/covers can be found on www.em-group.com.

Height bed frame: 12 cm.

Height headboard: 112 cm.

Material: Cover 100% polyester.

Weight approx. 330 g/m².

ARYA DENVER	Single bed	Double bed
WxL cm	90x200	180x200
Weight in kg	38	71
taupe	⁷ 30002434	30002424
rust	30002433	⁸ 30002432
aqua	30002430	⁹ 30002431
Pc. €	339,-	669,-



taupe



rust



aqua

Leg sets for upholstered beds

Choose from different leg sets and combine your individual bed! These modern legs are available in a pack of 4.

Leg sets for upholstered beds	Height in cm	Ref.	Set of 4 €
conical			
¹⁰ NEW Wooden leg MANOLA	16	30003089	29,99
¹¹ Metal leg ESTON	15	10061014	29,99
curved			
¹² NEW Metal leg MORRIN	17	30003090	34,99



Create your box spring bed with fabric cover MANHATTAN

1/ Select a box

4 fabric colors / 1 imitation leather



2/ Select legs

3 models



CHAPLIN



KYLE



VIDORA

3/ Select a headboard

2 models – 2 sizes – 2 materials

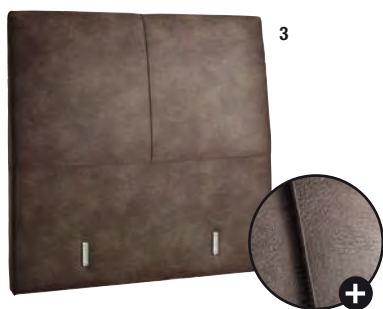

Conical headboard



Headboard with diamond quilting

Synthetic fiber

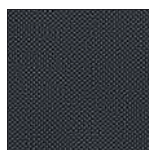

smoky blue



chocolate



sand

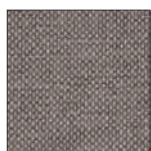

light grey

Imitation leather

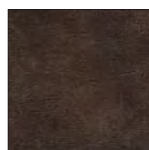

brown

Box spring bed with fabric cover MANHATTAN

7-zone pocket spring box:

- 7 zones for perfect support of the body
- 30 cm high box with pocket springs in different thicknesses for an individual suspension
- Substructure made of wood with tine glueing on the edges for maximum load capacity
- 250 springs/m²

Leg sets:

- Choose from metal or wooden legs
- Easy attachment to the box with supplied screws

Headboard:

- Available in conical shape or with diamond quilting
- High-quality workmanship
- Durable and stain-resistant
- Material: 100% polyester

Legs	Material/ color	Height in cm	Ref.	Pack of 4 €
5 Metal leg – CHAPLIN	metal/silver	13,0	10001314	59,99
6 Wooden leg – KYLE	wood/silver	8,5	10067155	39,99
7 Wooden leg – VIDORA	wood/black	8,5	10087447	69,99



7-zone pocket spring box
MANHATTAN, from
389⁰⁰

- Cover made of fabric or imitation leather
- Modular system
- Easy assembly



Conical headboard
MANHATTAN,
160x160 cm
449⁰⁰



MANHATTAN cm	7-zone pocket spring box		Conical headboard		Headboard with diamond quilting	
	90x200	100x200	160x160x16	260x160x16	160x160x16	260x160x16
smoky blue	30015174	1 10001327	10003799	10003804	10003789	4 10003794
chocolate	30015173	10001328	10003800	10003805	10003790	10003795
sand	30015176	10001329	10003801	10003806	10003791	10003796
light grey	30015175	10001330	10003802	10003807	10003792	10003797
Imitation leather brown	30015172	2 10003788	3 10003803	10003808	10003793	10003798
Pc. €	389,-	399,-	449,-	499,-	499,-	549,-



NEW

Chair-bed with metal leg
MANHATTEN
599⁰⁰

- Fabric or imitation leather cover
- Including mattress



Skirting for chair-bed
49.99

i Chair-bed with fabric cover MANHATTEN

This high-quality chair-bed can be easily transformed into a comfortable side bed. Thanks to its metal frame and chipboard structure, it is very stable and robust. Even more attractive is the unfolded chair in combination with the matching skirting, which is available separately.

Fabric

Leather look



1 smoky blue 2 chocolate 3 sand 4 light grey 5 brown

Chair-bed MANHATTEN

Color and fabric matches with the box spring beds. In just a moment, the luxurious armchair turns into a rollaway bed of the size 90x200 cm. A high-quality comfort foam mattress with a height of 11 cm is already integrated.

Durable folding mechanism & high-quality spring suspension. Easy to use.

Replacement mattress available on request.

Material: 100% polyester.

Skirting for chair-bed

Matching skirting for the chair-bed. With padding to cover the bars. Conjures a luxurious look. Fast & easy handling. You can also use the skirting to cover the bed.

Fabric cover: 100% polyester.

Filling: 100% polyester.

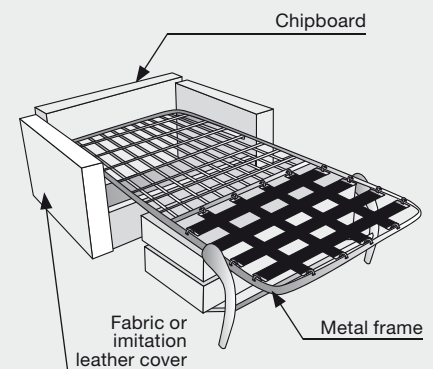

MANHATTEN	LxWxH cm	Fabric				Leather look	Pc. €
		1 smoky blue	2 chocolate	3 sand	4 light grey	5 brown	
with metal leg	134x95x85	10001317	10001318	10001319	10001320	10001321	599,-
with wooden leg	134x95x85	30001931	30001933	30001932	30001930	30001929	599,-
Skirting	90x200	10001322	10001323	10001324	10001325	10001326	49,99



Box spring bed - complete set
Double bed

799⁰⁰

- Comfortable
- High-quality workmanship
- Complete set

6

i Box spring bed - complete set:
Comfort at all levels

The frame of our box spring bed consists of a solid wood frame with a Bonnell pocket spring box, which makes the bed wonderfully comfortable. The legs and the Bonnell pocket spring mattress also promise optimum ventilation and moisture regulation. You can also put a topper on the bed (included in the complete set), to give your guests even more comfort. Another important element is the headboard, which gives the box spring bed a special appeal. The result: A stable and very comfortable bed for your guests.

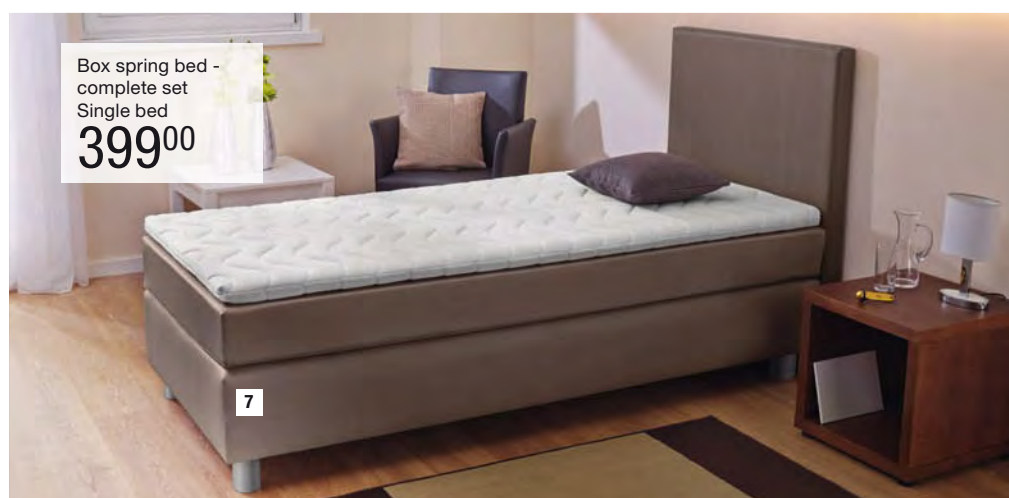

Box spring bed - complete set
Single bed

399⁰⁰

7



Imitation leather



6 beige 7 dark grey

Fabric



8 light grey 9 chocolate

Box spring bed - complete set

With our inexpensive complete set you receive a box spring bed consisting of Bonnell box, Bonnell mattress, comfort foam topper, a classic straight headboard and legs.

- Height box + mattress + topper: 47 cm
- Height headboard: 110 cm
- Bonnell pocket spring box
- Bonnell pocket spring mattress (115 springs/m²)
- Topper with comfort foam filling
- Headboard with upholstery made of imitation leather or fabric
- Round legs made of stained wood, height 10 cm, color silver

- Available with 2 covers (imitation leather or fabric)
- Delivery including connecting element

Box spring bed complete set cm	Single bed 90x200	Double bed 180x200
Cover imitation leather		
6 beige	10086727	10086728
7 dark grey	10086729	10086730
Pc. €	399,-	799,-
Cover fabric		
8 light grey	30014306	30014305
9 chocolate	30014304	30014307
Pc. €	399,-	799,-



Upholstered bed, from **99⁹⁹**

■ Frame and slats made of solid wood

Leg set 4-piece, from **9⁹⁹**



Upholstered bed

This upholstered bed is ideal for hotels and guest rooms. Frame and slats are made of solid spruce wood. The foam padding is 1 cm thick and equipped with a polyester cover. Suspension depending on the length, containing up to 12 slats. From a width of 140 cm, the bed is equipped with a double reinforcing bar. Height (without legs): 12 cm. Delivered with round beech wood legs (also available separately). Mounting of other legs is possible – see fig. 2 - 6.

Material: 100% polyester, cover made of 100% polyester fabric (150g/m²).

Upholstered bed cm	1 person	2 persons	2 persons	2 persons
	90x200	140x200	160x200	180x200
1 white	10002646	10002648	10002649	10002673
Pc. €	99,99	149,-	169,-	199,-

Leg sets

You have the choice between five different variants. Combine your individual bed!

Legs	Height cm	Ref.	Pack of 4 €
round			
2 silver stained wood	10,0	10067263	9,99
3 lacquered beech natural	15,0	10067264	14,99
rectangular			
4 silver stained wood	8,5	10067155	39,99
5 black silver stained wood	8,5	10087447	69,99
conical			
6 Metal	15,0	10061014	29,99

NEW Folding bed with mattress **149⁰⁰**



■ Foldable
■ With wheels



Folding bed

Fast and easy handling. Space-saving. With foam mattress (density 21 kg/m³), height 9 cm. Integrated slatted frame with 14 wooden slats.

Cover mattress: 100% polyester fleece, not removable.

Folding bed with mattress WxL in cm	90x200
7 black	10001315
Pc. €	149,-

NEW Slatted frame KOMFORT, from **99⁹⁹**

Adjustable



Slatted frame KOMFORT

Slatted frame made of sturdy plywood frame with multiple glued wooden slats in movable caps. Center belt for optimum load distribution. Individually adjustable center zone for an optimum hardness regulation. The head and foot zone can be adjusted in height several times. Suitable for all types of mattresses.

KOMFORT	1 person		
WxL in cm	80x200	90x190	90x200
Wooden slats	28	26	28
8 beech	30017893	10016605	10016606
Pc. €	99,99	99,99	99,99

KOMFORT	1 person	2 persons
WxL in cm	100x200	140x200
Wooden slats	28	28
beech	10016607	30017892
Pc. €	99,99	139,-

NEW Slatted frame SPRING, from **199⁰⁰**

Adjustable



Slatted frame SPRING

7 zones. 7-fold glued wooden slats in highly flexible, resilient rubber mounts. With spring attachment for easy cleaning under the bed. Individually adjustable middle zone. Foot and head zone are adjustable into multiple heights. Suitable for all types of mattresses.

SPRING	1 person		
WxL in cm	80x200	90x190	90x200
Slats	42	42	42
9 grey/white	30014599	30014601	10001991
Pc. €	199,-	199,-	199,-

SPRING	1 person	2 persons
WxL in cm	100x200	140x200
Slats	42	42
grey/white	10001992	10001993
Pc. €	199,-	239,-

NEW Slatted frame TELLER, from **249⁰⁰**

Adjustable
3D suspension

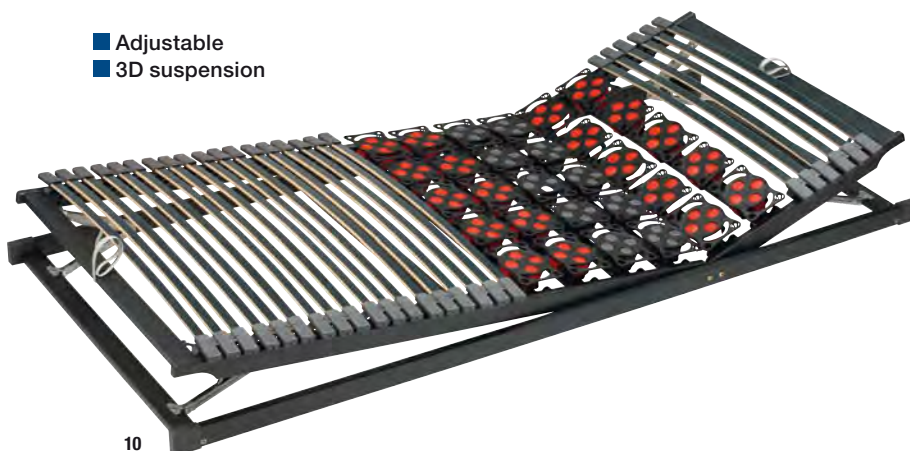

Slatted frame TELLER

Let yourself be inspired in functionality by the slatted frame made of super-adaptable plate elements and high-quality wooden slats in a frame made of laminated wood. Offer your guests a comfort that was previously not possible! The head and foot zone are adjustable into multiple heights and offer your guests a high degree of customization, which, together with the individually adaptable plate inserts in the shoulder area, promises maximum sleeping comfort. Suitable for all types of mattresses.

TELLER	1 person		
WxL in cm	80x200	90x190	90x200
10 grey	30014600	10028518	10028519
Pc. €	249,-	249,-	249,-

TELLER	1 person	2 persons
WxL in cm	100x200	140x200
10 grey	10028520	10028521
Pc. €	249,-	299,-



Pocket spring mattress
WELLNESS, from
249⁰⁰

1

20 cm

- Ideal ventilation due to spring core
- 7-zone mattress
- Removable cover



299 springs/m² (100x200 cm)

Pocket spring mattress WELLNESS

The 7-zone wellness mattress, a pocket spring mattress with an additional nap foam pad that relieves pressure and supports effectively. The division into 7 different zones ensures precise support of the individual parts of the body. Foam rows are fitted between the individual pocket spring rows to increase the support function and point elasticity. These provide additional supporting force and prevent sinking too deeply. The anti-stress processing of the cover reduces the electrostatic charging of the body. Sleep is peaceful, deeper and more intense. The cover also ensures a high level of moisture absorption, good moisture transport and is permanently antistatic. It is equipped with an all-round zipper and washable up to 60 °C. Four loops facilitate the turning of the mattress. Total height of the mattress is approx. 20 cm. Suitable for adjustable slatted frames. 299 springs/m² at 100x200 cm, hardness class 2. Quality made in Germany.

Material: Cover: 44% lyocell, 32% polyamide, 21% polyester, 3% viscose, 60 °C washable.

WELLNESS		1 person		
cm		90x190	90x200	100x200
1	white	10066047	10066112	10066113
Pc. €		249,-	249,-	249,-
WELLNESS		2 persons		
cm		140x200		160x200
1	white	10069533		10069534
Pc. €		379,-		419,-

Pocket spring mattress
KOMFORT, from

189⁰⁰

- Ideal ventilation due to spring core
- 7-zone mattress
- Removable cover



19 cm

2



299 springs/m² (100x200 cm)

Pocket spring mattress KOMFORT

Foam rows are fitted between the individual pocket spring rows to increase the support function and point elasticity. These provide additional supporting force, prevent sinking too deeply and offer a high point elasticity at the same time. In addition, this object mattress has reinforced edges with seat edge for better getting in and out. Cover quilted on both sides with climate fiber (100% polyester), for a pleasantly dry sleeping climate. Four loops facilitate the turning of the mattress. Mattress height approx. 19 cm – suitable for adjustable slatted frames. 299 springs/m² at 100x200 cm, hardness class 3. Quality made in Germany.

Material: Cover: 75% viscose, 25% polypropylene, 60 °C washable.

KOMFORT		1 person		
cm		90x190	90x200	100x200
2	white	10061402	10061439	10061440
Pc. €		189,-	189,-	189,-
KOMFORT		2 persons		
Dim. cm		140x200		160x200
2	white	10061442		10061601
Pc. €		309,-		349,-

Bonnell mattress KOMFORT, from

129⁰⁰

Bonnell mattress KOMFORT

Reliable and robust 4-way bonnell spring system with reinforced edges and a sitting edge, for easier getting in and out of the mattress. Strong drill, both sides quilted with climate fiber (100% polyester). The climate fiber transports moisture away from the body and thus ensures a pleasantly dry sleeping climate. Four handles facilitate the turning of the mattress. Mattress height approx. 19 cm. 176 springs/m² at 100x200 cm, hardness class 3. Quality made in Germany.

Material: Cover: 66% polypropylene, 34% polyester.

KOMFORT		1 Person		
cm		90x190	90x200	100x200
3 white		10066577	10066578	10066769
Pc. €		129,-	129,-	129,-
KOMFORT		2 Personen		
cm		140x200	160x200	
3 white		10069536	10086770	
Pc. €		229,-	279,-	



■ With reinforced edges for easier getting in and out



176 springs / m² (100x200 cm)

Bonnell mattress XXL

For particularly high demands— especially at weight load – we recommend the robust 4-way bonnell spring mattress with a comfortable height of approx. 24 cm. The design-related cavity inside guarantees a good air exchange. The comfortable foam covering and the strong drill, both sides quilted with climate fiber (100% polyester), also provide a pleasantly dry sleeping climate. The stable spring system withstands even higher weight load and four handles facilitate the turning of the mattress. 176 springs/m² at 100x200 cm, hardness class 3. Quality made in Germany.

Material: Cover: 69% viscose, 31% polypropylene.

XXL		1 person		
cm		90x190	90x200	100x200
4 white		10066770	10066975	10066976
Pc. €		179,-	179,-	179,-
XXL		2 persons		
cm		140x200	160x200	
4 white		10069535	10086774	
Pc. €		299,-	349,-	

Bonnell mattress XXL, from

179⁰⁰

■ Extra high

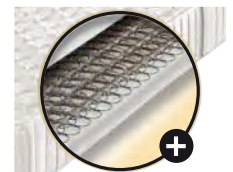

176 springs / m² (100x200 cm)

Cold foam mattress EXKLUSIV

The 7-zone cold foam mattress with a density of 40 kg/m³ allows through the 3D-cutting technique an ergonomically perfect body adaptation and high point elasticity. The 3D pads ensure increased contact comfort and especially reduced ground pressure. The high-quality and wonderful soft cover is equipped with aloe vera and Silver Sleep and thus ensures a high moisture absorption and quick drying. It is insensitive to fungi and bacteria and also antistatic. The cover is equipped with an all-round zipper and washable up to 60 °C. Four loops facilitate the turning of the mattress. Mattress height approx. 21 cm – suitable for adjustable slatted frames. Hardness class 2. Quality made in Germany.

Material: Cover: 60% polyester, 40% viscose, 60 °C washable.

EXKLUSIV		1 person		
cm		90x190	90x200	100x200
5 white		10062543	10062544	10062582
Pc. €		249,-	249,-	249,-
EXKLUSIV		2 persons		
cm		140x200	160x200	
5 white		10069527	10086772	
Pc. €		379,-	429,-	

Cold foam mattress EXKLUSIV, from

249⁰⁰

- Cover with aloe vera and Silver Sleep
- 7-zone mattress
- Removable cover



Density 40 kg/m³



- 886 springs at 100x200 cm
- Lying comfort like on a box spring bed
- High-quality, double pocket springing
- Removable cover

Box spring mattress LUXUS

Bring the benefits of a box spring bed into your bed with the luxury box spring mattress. The 7-zone mattress can be used on both sides. On the one hand side you can enjoy luxury sleeping comfort on a comfort foam pad, the other side offers the perfect support for your body with a comfortable latex pad. The mattress supports with its high-quality double pocket springing and optimally meets your body needs. The cover is highly breathable and climate regulating, thus your sleep is calmer and more intense. The zipper allows easy removal of the cover. Height of the mattress is 40 cm.

Cover fabric: 100% polyester. Weight approx. 230 g/m². Total weight: 32 kg at 90x200 cm. At size 100x200 cm the mattress contains 886 springs.

LUXUS cm	1 person	
	90x200	100x200
1 white	10011122	10011175
Pc. €	429,-	429,-
LUXUS cm	2 persons	
	140x200	160x200
1 white	10011176	10011217
Pc. €	499,-	569,-



The right mattress for every demand

■ **Box spring**

- Very good ventilation
- Very good punctual support of the body
- Comfortable sleeping climate
- Turn your basic bed into a great box spring bed (not usable on boxes pring beds)

■ **Pocket spring**

- Robust and flexible
- Punctual support of the body
- Very good ventilation
- Suitable for adjustable slatted frames

■ **Cold foam**

- Lightweight and adjustable
- Easy handling
- Very good punctual support of the body
- Good ventilation
- Comfortable sleeping climate
- Suitable for adjustable slatted frames

■ **Bonnell spring**

- Inexpensive and areal elastic
- Areal support of the body
- Very good ventilation
- Robust construction
- Not suitable for adjustable slatted frames

NEW

Cold foam mattress
PREMIUM, from
429⁰⁰



26 cm

- Anti dust mites treatment Greenfirst®
- 7 zones
- Cold foam
- Removable cover

Cold foam mattress PREMIUM

This 7-zone cold foam mattress provides firm body support and a comfortable sleeping comfort. In addition, it is ideal for allergy sufferers due to the anti mite Greenfirst cover. The quilted cover has a four-sided zipper, so that it can be easily removed. The mattress is suitable for all types of sleep and can be rotated and turned by mirrored construction. Handles at the side make turning easier.

Cover fabric: 100% polyester. Quilting 100% polyester (260 g/m²).

Total height of mattress: 26 cm, density: 40 kg/m³.

Cold foam core.

PREMIUM cm	1 person		2 persons	
	90x200	100x200	140x200	160x200
2 white	10001296	10001297	10001298	10001299
Pc. €	429,-	429,-	499,-	569,-

NEW



Double bed bridge
19⁹⁹

i **PRODUCT INFO**
Cold foam 40 kg/m³

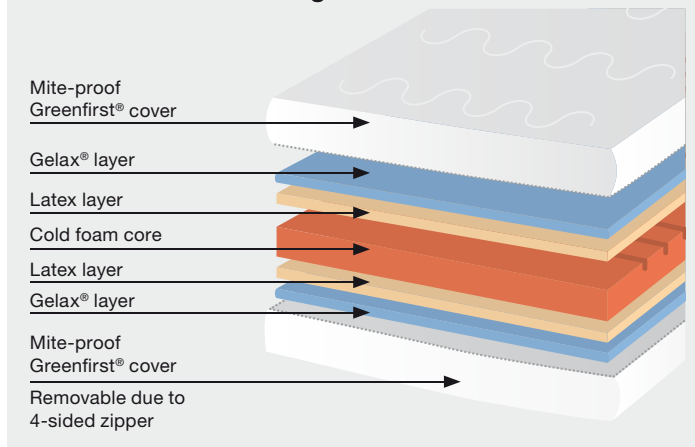

Double bed bridge

This practical double bed bridge closes the annoying gap between two mattresses and thus forms a continuous lying area. It is hardly noticeable and offers a high comfort with its surface made of pleasantly soft terry stretch with approx. 68% cotton and 32% polyester. The foam bridge closes the drafty gap, cushions hard edges and prevents slipping. Easy to handle, suitable for all mattresses with length of 200 cm. Use one of our fitted sheets for double beds!

Material: 68% cotton, 32% polyester. Not washable.

Double bed bridge	Ref.
3 25x200 cm	10085567
Pc. €	19,99

Please call us at
+49 8272 807 447

Worldwide
delivery

Please visit us at
www.em-group.com



Topper BASIC DREAM, from **32⁹⁹**

- Filling: 100% polyester hollow fiber
- Height 1 cm

Topper BASIC DREAM

Easy to care for, hygienic and inexpensive, an optimal alternative to conventional bedding. Filling and cover are of noticeably high quality. The super siliconized hollow fiber ensures moisture transport and is very easy-care. The checked single quilting with round roll guarantees perfect fit of the content.

Filling: 100% polyester hollow fiber, Cover: 100% polyester, microfiber, white. 95 °C washable. Tumble drying possible.

DREAM		1 person	
cm		90x190	90x200
1 white		10016083	10002670
Pc. €		32,99	32,99
DREAM		2 persons	
cm		140x200	160x200
1 white		10002671	10016085
Pc. €		42,99	49,99
DREAM		2 persons	
cm		180x200	
1 white		10002672	
Pc. €		52,99	



NEW

Topper KOMFORT, from **69⁹⁹**

Topper KOMFORT

The topper KOMFORT ensures a better pressure relief due to the nub structure of the foam insert. The cover can be removed easily due to the 3-sided zipper and is washable at 95 °C.

Cover: 50% cotton, 50% polyester. 95 °C washable.

Core: Comfort foam.

KOMFORT		1 person	
cm		90x200	100x200
2 white		10065747	10065748
Pc. €		69,99	69,99
KOMFORT		2 persons	
cm		140x200	180x200
2 white		10065749	10065750
Pc. €		99,99	119,-
KOMFORT		2 persons	
cm		200x200	
2 white		10065751	
Pc. €		139,-	



VEGA offers several kinds of topper

BASIC DREAM – with filling made of polyester fibers

The topper with siliconized polyester hollow fibers is soft and comfortable. It is easy to care for and is held in place by rubbers in the corners.

KOMFORT – with cold foam

Due to its honeycomb structure, the cold foam topper offers a good pressure relief and thus forms a comfortable lying surface. It is held in place by four rubbers in the corners and has a removable and washable cover.

EXKLUSIV – with viscoelastic foam

Viscoelastic foam adapts perfectly to the body. It distributes the body pressure equally and thus allows a good sleep. Its hypoallergenic, easy-care cover has a zipper and can be easily removed.

LUXUS – with gel foam filling

Its viscoelastic foam ensures a perfect sleep, because it relieves and distributes the body pressure optimally. Its microcapsules with a climate-regulating gel guarantee that the lying surface always remains pleasantly cool.

POCKET SPRING - TOPPER

The core of this topper consists of arched springs, which are individually wrapped in fabric bags and can react very accurately to pressure. This topper perfectly supports the body and especially the spine. It promises optimal ventilation for an ideal sleeping.

Topper EXKLUSIV

Quilted mattress topper and ergonomic, viscoelastic pad in one! The viscoelastic foam in the core (all sizes = 4 cm, except 200/200 = 5cm)) adapts with heat individually to the body and provides pressure-relieving sleeping comfort. The 4 sided zipper allows easy removal. Suitable for house dust mites allergy sufferers, high standard of hygiene. In addition to the functionality the topper convinces by the pleasant feel of its both sides quilted cover with a climate fiber made of 100% polyester.

Cover fabric: 66% polyester, 34% cotton. 60 °C washable.

EXKLUSIV	1 person	
cm	90x200	100x200
3 white	10087438	10087439
Pc. €	99,99	99,99

EXKLUSIV	2 persons	
cm	140x200	160x200
3 white	10087440	10005975
Pc. €	149,-	179,-

EXKLUSIV	2 persons	
cm	180x200	200x200
3 white	10087441	10087442
Pc. €	199,-	229,-



Gel topper LUXUS

Premium class topper with gel foam filling for maximum adaptability regardless of temperature conditions. A 4-sided zipper allows quick and easy cleaning of the cover, which is washable at 60 °C. The wonderful lying comfort is enhanced by excellent climate control and breathability. The opulent height of 8 cm also compensates for small inappropriate properties of the mattress.

Cover: 100% polyester. 60 °C washable.

LUXUS	1 person	
cm	90x200	100x200
4 white	10028522	10002517
Pc. €	149,-	149,-

LUXUS	2 persons	
cm	140x200	180x200
4 white	10002518	10002538
Pc. €	199,-	249,-

LUXUS	2 persons	
cm	200x200	
4 white	10002519	
Pc. €	299,-	



Pocket spring topper

The cover is made of medically tested double jersey and quilted with climate fiber - this makes the topper particularly breathable and improves the temperature compensation. The topper regulates the moisture and deduces the body heat optimally. The core of the topper consists of pocket springs, which give in point elastic and cushion the body pleasantly. The height of 9 cm promises optimal sleeping comfort. Cover is washable due to the all-round zipper. Suitable for house dust allergy sufferers.

Cover fabric: 100% polyester. 60 °C washable.

Topper	1 person	
cm	90x200	100x200
5 white	30002854	30002850
Pc. €	149,-	149,-

Topper	2 persons	
cm	140x200	180x200
5 white	30002851	30002852
Pc. €	199,-	249,-

Topper	2 persons	
cm	200x200	
5 white	30002853	
Pc. €	299,-	





■ Quilted

Bed runner
ALABAMA, from
29.99

Bed runner



grey

camel

dark brown

Bedskirt und pillow cover



grey

camel

dark brown

Bed runner, bedskirt and pillows ALABAMA

For each particularly elegant ambience, these quilted bed runners and pillow covers made of suede leather imitation on the surface are an excellent choice. The undersides are each held tone in tone in easy-care polyester. The bed runner is square quilted (20x20 cm) and framed by a border (7 cm).

- **Material bed runner: Surface 100% polyester (185 g/m²), Underside 100% polyester (92 g/m²).**
 - **Material bedskirt: Surface 100% polyester (185 g/m²), Underside 100% polyester (92 g/m²).**
 - **Material pillow cover: 100% polyester (185 g/m²). Quilting: 100% polyester (150 g/m²).**
- 40 °C washable. Do not chlorinate, do not tumble dry.**

ALABAMA	Bed runner		Bedskirt			Pillow cover
	1 person	2 persons	1 person	2 persons	2 persons	
cm	80x135	80x200	90x190	140x190	160x200	40x40
grey	10016088	1 10016089	10016092	10016093	2 10016094	3 10016086
camel	10016331	10016332	10016335	10016336	10016337	10016329
dark brown	10016341	10016342	10016345	10016346	10016347	10016339
	Pc.	Pc.	Pc.	Pc.	Pc.	Pack of 2
€	29,99	34,99	24,99	29,99	34,99	9,98



Bed runner

Bedskirt

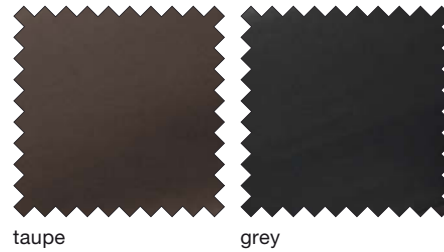

Bed runner and bedskirt CALIPSO

Decorative bed runner made of imitation leather with an elegant quilted design in stylish plaid 10x10 cm pattern in excellent quality. The underside is made of a very soft and velvety fabric in the same color. Bedskirt is not quilted, overlapped on 3 sides.

- Material bed runner: Surface 50% PVC, 40% cotton, 10% polyurethane (450 g/m²), surface 100% polyester (90 g/m²). Quilted bed runner surface 100% polyester (100 g/m²).
- Material bedskirt: Surface 50% PVC, 40% cotton, 10% polyurethane, (450 g/m²), underside 100% polyester (90 g/m²).

CALIPSO	Bed runner		Bedskirt	
	2 persons	1 person	2 persons	2 persons
cm	60x200	90x190	140x190	160x200
taupe	10064331	10064332	10064333	10064334
grey	4 10064384	10064385	5 10064386	10064393
€	Pc. 34,99	Pc. 29,99	Pc. 34,99	Pc. 39,99



- Quilted effect
- Usable on both sides

Bed runner
PALMITO, from
19.99



blue

plum

grey

Bed runner and pillows PALMITO

Available in 3 current trendy colors this bed linen is slightly pleated and decorated with seams to create an elegant atmosphere in your rooms. The bed runner is usable on both sides. Easy covering of the pillow cover due to the zipper.

Material: 100% polyester.

Weight approx. 336 g/m². 40 °C washable.

Do not chlorinate, do not tumble dry.

PALMITO	Bed runner		Pillow cover	
	1 person	2 persons	40x40	30x50
cm	65x135	65x200	40x40	30x50
blue	10063595	10063596	10063594	5 10063593
plum	10064088	1 10064089	3 10064087	10064086
grey	10063313	2 10063314	4 10063312	6 10063216
€	Pc. 19,99	Pc. 24,99	Pack of 2 13,98	Pack of 2 13,98

Bed runner

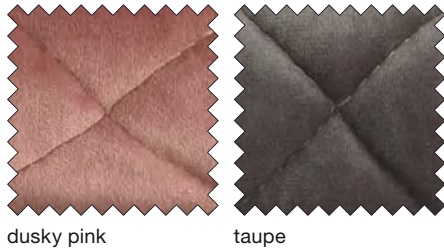

dusky pink

taupe

Pillow cover



dusky pink

taupe

Bed runner and pillows SAMARA

Velvet - the fabric of kings! With our accessories of series SAMARA you will charm your guests and give your beds a noble touch. Pillow covers and bed runners are available in attractive colors and can be wonderfully combined with our bed linen series. The bed runner with its stylish diamond quilting is padded and has a high-quality fitted mitered hem. You can create a royal ambience in your rooms!

Material: 100% polyester. 30 °C washable. Weight approx. 290 g/m².

SAMARA	Bed runner		Pillow cover	
	2 persons 65x200	2 persons 65x250	40x40	30x50
dusky pink	30002508	30002541	30002511	30002510
taupe	30002521	7 30002542	30002504	8 30002517
	Pc.	Pc.	Pc.	Pc.
€	49,99	59,99	9,99	9,99

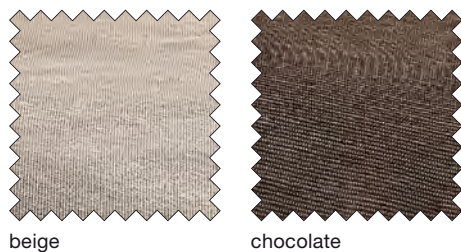

beige

chocolate

■ Usable as blanket

Bed runner COSTA

Stylish woven bed runners in trendy colors. The elegant bed runner, edged with a 1 cm wide bias tape can also be used as a blanket.

Material: 50% acrylic, 30% polyester, 20% cotton. 40 °C washable. Do not chlorinate, do not tumble dry. Weight approx. 200 g/m².

COSTA	1 person	2 persons
cm	138x145	138x210
beige	10068337	9 10068338
chocolate	10068339	10069310
	Pc.	Pc.
€	22,99	24,99

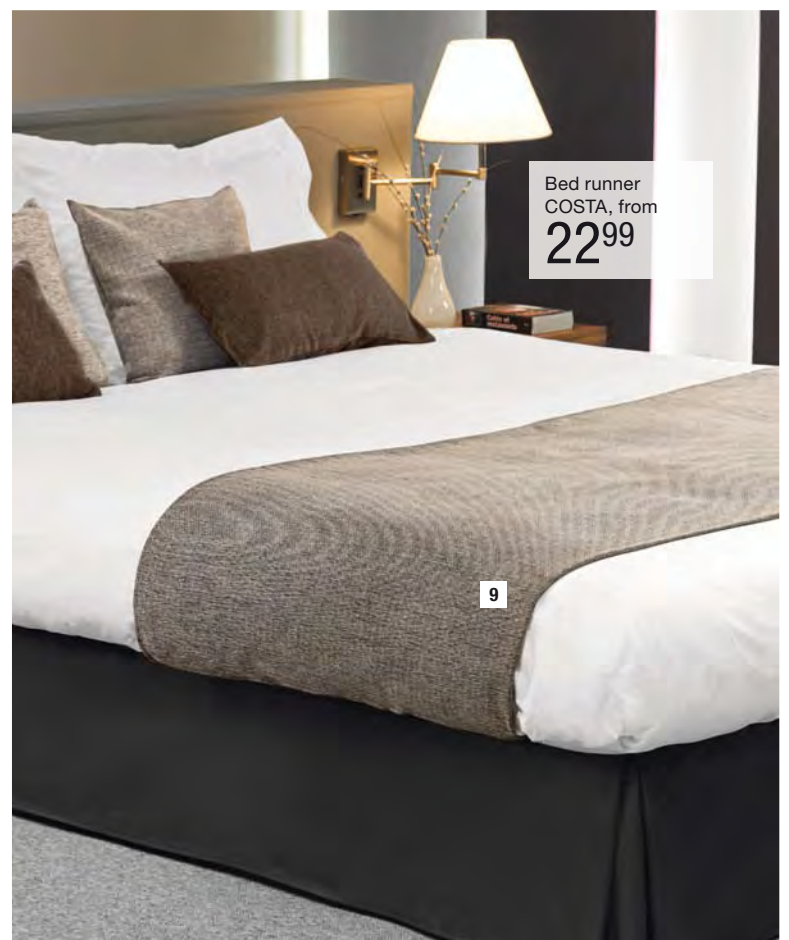



Bedskirt
CORFOU, from
19⁹⁹

6

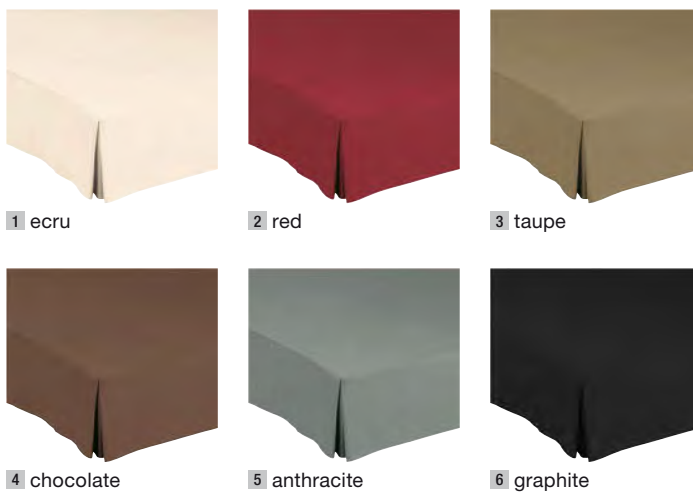

1 ecru

2 red

3 taupe

4 chocolate

5 anthracite

6 graphite

Bedskirt CORFOU

Bed slip covers for a well-kept presentation of your rooms.

Material: 70% cotton, 30% polyester. 30 °C washable.
Weight approx. 170 g/m².

CORFOU cm	1 person		2 persons	
	90x190	140x190	160x200	180x200
1 ecru	10000725	10000723	10000724	10000722
2 red	10000737	10000735	10000736	10000734
3 taupe	10000745	10000743	10000744	10000742
4 chocolate	10000741	10000739	10000740	10000738
5 anthracite	10000717	10000715	10000716	10000714
6 graphite	10000729	10000727	10000728	10000726
Pc. €	19,99	22,99	25,99	29,99



Bed runner
MADEIRA, from
19⁹⁹

8

- Usable on both sides
- Invisible seam



7

8

9

Bed runner MADEIRA

This elegant two-colored bed runner is usable on both sides and very practical. With invisible seam. The noble material with the discreet color structure gives your beds the classic-exclusive hotel touch and is ideal for protecting your duvet covers and bedspreads.

Material: 70% cotton, 30% polyester. 30 °C washable.
Do not chlorinate, do not tumble dry. Weight approx. 170 g/m².

MADEIRA cm	1 person	2 persons
	80x135	80x200
7 chocolate/beige	10062719	10062941
8 taupe/ecru	10062943	10062944
9 anthracite/grey	10062716	10062717
Pc. €	19,99	24,99

Blanket
ARKTIS, from
9⁹⁹

■ New size

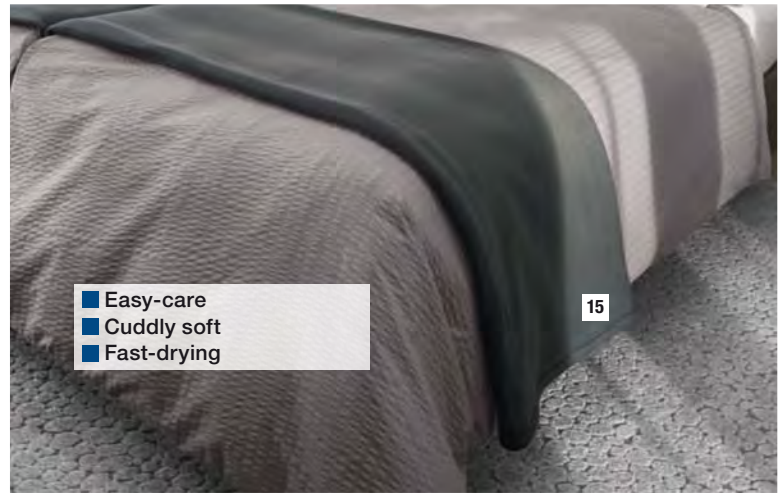

- Easy-care
- Cuddly soft
- Fast-drying

15

Blanket ARKTIS

Soft, cuddly, in best quality and optimal material composition for a comfortable sleeping climate. Benefits: Easy to clean, easy to wash, fast-drying and very durable! More colors can be found on www.em-group.com.

Material: 100% polyester, easy-care, 40 °C washable. Weight approx. 280 g/m².

ARKTIS cm	1 person			2 persons
	NEW 130x170	150x200	180x220	240x220
10 beige	10030650	10057903	10057904	10057905
11 dark blue	10030653	10057906	10057907	10057908
12 peach	-	10057922	10057923	10057924
13 linen red	-	10057925	10057926	10057927
14 indian red	10030652	10057913	10057914	10057915
15 anthracite	10030651	10048218	10048219	10048220
16 chocolate	-	10055270	10055271	10055272
17 kiwi	-	10055276	10055277	10055278
Pc. €	9,99	12,99	16,99	19,99



NEW

■ Boil-proof

18



NEW

25

23

24

Blanket
POLAR
34⁹⁹



18

19

20

21

22

Blanket
MELANGE
29⁹⁹



23

24

25

Blanket POLAR

Our boil-proof blanket remains dimensionally stable and colorfast even at washing temperatures of up to 95 °C. Choose our blanket POLAR for a hygienic sleep.

Material: 50% cotton, 50% polyester. 95 °C washable. Weight approx. 535 g/m².

POLAR cm	1 person 140x200
18 off-white	10015357
19 yellow	10015355
20 sand	10004712
21 beige	10015356
22 silver	10004713
Pc. €	34,99

Blanket MELANGE

Lightweight, colorfully woven flannel fleece blanket for the high demands of the hotel and catering industry: easy-care, fast-drying, high color fastness and low weight.

Material: 100% polyester. 40 °C washable. Weight approx. 350 g/m².

MELANGE cm	1 person 150x200
23 grey	10003595
24 anthracite	10003596
25 brown	10003594
Pc. €	29,99



Please call us at
+49 8272 807 447



Worldwide
delivery



Please visit us at
www.em-group.com



Duvet cover
NEVA, from
39⁹⁹

> Pillow covers MALVA can be found on www.em-group.com.

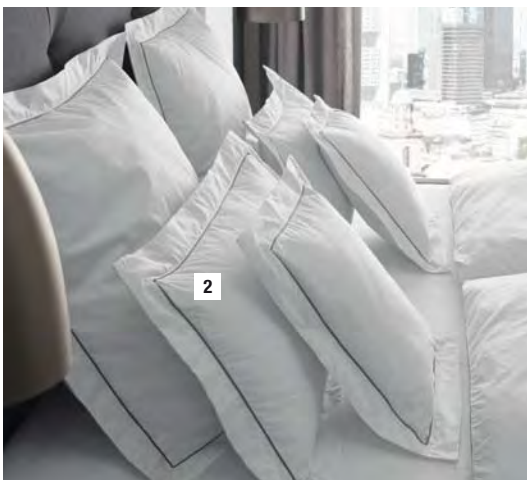

- 100% cotton
- Stand-up hem
- Colorfast piping
- Hotel quality

Pillow cover
NEVA, from
8⁹⁹



NEVA cm	Duvet cover (without pillow cover)		
	135x200	155x220	240x220
white/ taupe	10025049	30002019	10001725
2 white/grey	10001745	10001746	10001763
Pc. €	39,99	49,99	52,99

NEVA cm	Pillow cover			
	40x40	40x80	60x80	80x80
white/ taupe	10082994	10089209	10001719	10025039
2 white/grey	10001750	10001748	10001744	10001749
Pc. €	8,99	10,99	12,99	14,99

NEVA cm	Bed sheet (without decorative stitching)	
	150x250	260x260
1 white	10001730	10001731
Pc. €	24,99	34,99

Bed linen NEVA

The pure white bed linen NEVA made of the finest yarns with an exclusive tuck embroidery is the new highlight in your rooms. The gentle quality surrounds your guests delicately and ensures a restful sleep. With hotel closure.

Also order: Bed sheet in fitting design.

Material: 100% cotton. 60 °C washable, do not chlorinate.

Tumble drying possible. Weight approx. 130 g/m².



Bed set
ROM, from
1799

3



Box spring bed
can be found on page 37 and on

www.em-group.com

Pillow cover
ROM, from
3,99

- 100% cotton
- Brilliant shine
- Hotel quality



ROM	Bed set	
Pillow cover cm	80x80	40x80
Duvet cover cm	135x200	135x200
3 white	10017997	10018279
Pc. €	19,99	17,99

ROM	Pillow cover			
cm	40x40	40x80	60x80	80x80
3 white	10017993	10017994	10018176	10017996
Pc. €	3,99	5,99	6,99	7,99

ROM	Bed sheet		Yardware
cm	150x250	220x260	280
3 white	10003174	10003175	10002605
Pc. €	14,99	17,99	7,99



Bed linen ROM

Hotel bed linen with a classic stripe design in best quality. Stripe width 25 mm. Pillow and duvet cover with hotel closure and additional decorative darts. Also order: Bed sheet in fitting design. More colors can be found on www.em-group.com.

Material: 100% cotton, mercerized. 95 °C washable, chlorine resistant. Weight approx. 180 g/m².

Please call us at
+49 8272 807 447

 **Worldwide delivery**

 Please visit us at
www.em-group.com

Bedding & Accessories



- Mercerized for highest durability
- Fine surface structure due to combed cotton

Pillow cover
EMMEN, from
6,99



Bed linen EMMEN

Finest damask bed linen with woven, classic 2 mm stripe design. The noble product in best hotel quality is a dream for the high standards. The covers are available with hotel closure, the king size duvet cover is available with button closure. Further colors can be found on www.em-group.com.

Material: 100% cotton, super combed, mercerized. 95 °C washable, chlorine resistant. Tumble drying possible.

Weight approx. 120 g/m².

EMMEN	Bed set		Duvet cover	Pillow cover				Yardware
Pillow cover cm	80x80	80x80		40x40	40x80	60x80	80x80	280
Duvet cover cm	135x200	155x220	240x220					
1 white	10076497	10076501	10065498	10076491	10076492	10076493	10076496	10084124
Pc. €	34,99	44,99	54,99	6,99	8,99	9,99	10,99	16,99



- High-quality damask
- No shrinking due to mercerization



Pillow cover
RIMINI, from
4,99



Bed set RIMINI

Top quality with noble look at a great price! Elegant, diagonally striped damask bed linen in exquisite hotel quality: First class in material and handling and extremely durable. With hotel closure. Also order: Bed sheet in matching design. Further colors can be found on www.em-group.com.

Material: 100% cotton, combed, mercerized.

95 °C washable, chlorine resistant. Weight approx. 150 g/m².

RIMINI	Bed set		Pillow cover			
Pillow cover cm	80x80	80x80	40x40	40x80	60x80	80x80
Duvet cover cm	135x200	155x220				
2 white	10017947	10017954	10017938	10017939	10017940	10017945
Pc. €	32,99	42,99	4,99	6,99	7,99	8,99

RIMINI	Bed sheet		Yardware	
cm	150x250	220x260	160	280
2 white	10005929	10005930	10000958	10017950
Pc. €	24,99	29,99	7,99	12,99



Duvet cover
BORA BORA
34⁹⁹

> Bedskirt CORFOU can be found on page 50.

- 50% cotton, 50% polyester
- Hotel quality

Pillow cover
BORA BORA
7⁹⁹



Bed linen BORA BORA

The easy-care bed linen made of a tightly woven blended fabric is ideal for everyday use. It is extremely easy to iron and easy to put on thanks to first-class handling. Also order: Bed sheet in matching design.

Material: 50% cotton, 50% polyester.

95 °C washable, do not chlorinate. Tumble drying possible.

Weight approx. 120 g/m².

BORA BORA	Duvet cover (with sack closure) (without pillows)	Pillow cover (with hotel closure)
cm	140x200	60x80
3 white	10015370	10015372
Pc. €	34,99	7,99
BORA BORA	Bed sheet	
cm	150x250	260x260
3 white	10000670	10002708
Pc. €	19,99	34,99



Please call us at
+49 8272 807 447



Worldwide
delivery



Please visit us at
www.em-group.com

i

Our fitted sheets

VEGA offers you different fitted sheets.

Cotton jersey

Jersey fitted sheets have several advantages. They are stretchy and very elastic and thus suitable for all mattresses. In addition, the soft and durable bed sheets are very easy-care because they do not need to be ironed.

Organic cotton jersey

These fitted sheets are made of organic cotton that is grown without pesticides and other chemicals. They are stretchy, very elastic and thus suitable for all mattresses. Since they do not have to be ironed, they are also very easy to care for.

Mikro modal jersey

Modal is a breathable natural fiber that is particularly soft and can absorb moisture very well. In addition, it is very durable: Even at frequent washing it retains its color and remains wonderfully soft. Since these bed sheets are stretchy and very elastic, they adapt to all mattresses. They are particularly easy-care and do not need to be ironed.

NEW

Fitted sheet
Micro Modal,
from

14,99

- High breathability
- Non-iron



Fitted sheet Micro Modal

The fitted sheet Micro Modal is pleasantly lightweight, cuddly and has a soft feel. The smooth surface provides excellent moisture absorption and high breathability - ideal for sensitive skin. Compared to viscose, modal provides improved tear strength and abrasion resistance and at the same time remains dimensionally stable even after frequent washing. Easy to put on, ideal fit, base height 25 cm.

Material: Jersey (non-iron): 100% micro modal. 60 °C washable.

Fitted sheet	90-100x200 cm	140-160x200 cm	180-200x200 cm
1 white	10085033	10085034	10085035
2 natural	10085036	10085037	10085038
3 sand	10085048	10085049	10085050
4 anthracite	10004997	10004998	10004999
Pc. €	14,99	20,99	24,99

NEW

Fitted sheet
organic cotton, from

14,99

- 100% organic cotton
- Non-iron



Fitted sheet organic cotton

The fitted sheet Bio is made of 100% organic cotton. For environmental protection, the ecological cultivation of organic cotton completely renounces the use of chemical pesticides and fertilizers. Only natural seed without genetic modification is used. Quick to put on, with optimal fit, durable. Base height 25 cm.

Material: Jersey (non-iron): 100% cotton, 60 °C washable.

Fitted sheet	90-100x200 cm	140-160x200 cm	180-200x200 cm
5 white	10085051	10085052	10085053
6 natural	10085054	10085056	10085055
7 sand	10085066	10085067	10085068
8 anthracite	10006576	10006577	10006578
Pc. €	14,99	20,99	24,99

www

More products

Mattresses >



Pillows >



Duvets >



www.em-group.com

NEW

Bed sheet
FORMATIC
9,99



Bed sheet FORMATIC

Pure white bed sheet with an integrated pocket into which your mattress (of approx. 12-15 cm height) can be easily inserted. Simply fold in the rest of the side parts under the mattress.

Material: 100% cotton. 95 °C washable, chlorine resistant. Weight approx. 140 g/m².

FORMATIC	90x200 cm	100x200 cm
9 white	10018248	10018249
Pc. €	9,99	9,99



Fitted sheet LOUISIANNA

The interlock fitted sheet of the top class. Double jersey knit - through this knitting technique, a picture in the cross section appears as if two single jersey cloths are overlaid. Particularly dimensionally stable, very high weight, great grip due to use of 100% high-quality cotton. Perfect fit due to tunnel rubber band with extra strong rubber. Base height 27 cm (fitted sheet in white also available with base height 40 cm).

Material: Jersey (non-iron): 100% cotton. 95 °C washable, chlorine resistant.

LOUISIANNA	90-100x200 cm	140-160x200 cm	180-200x200 cm
10 white, base height 27 cm	10001895	10001896	10001897
Pc. €	16,99	25,99	29,99
10 white, base height 40 cm	10001898	10001899	10001900
Pc. €	39,99	49,99	59,99
LOUISIANNA	90-100x200 cm	140-160x200 cm	180-200x200 cm
Base height 27 cm			
11 ecru	10001877	10001878	10001879
12 sand	10001889	10001890	10001891
13 peach	10001868	10001869	10001870
14 yellow	10001880	10001881	10001882
15 mango	10001886	10001887	10001888
16 light blue	10001874	10001875	10001876
17 blue	10001871	10001872	10001873
18 light green	10001883	10001884	10001885
19 silver	10001892	10001893	10001894
20 anthracite	10001865	10001866	10001867
Pc. €	17,99	29,99	34,99



NEW Fitted sheet
Elastic jersey, from
17⁹⁹

- Elastic jersey
- Non-iron



Jersey fitted sheet, from
14⁹⁹

- Boil-proof and chlorine resistant
- Value pack



Fitted sheet Elastic jersey

The fitted sheet elastic jersey impresses with extremely high elasticity and fit. With just one hand movement, this fitted sheet is perfectly smooth again and fits on oversize mattresses and waterbeds up to 220 cm. The all-round rubber band ensures a secure hold. Base height 28 cm. Further colors can be found on www.em-group.com.

Material: Jersey (non-iron): 96% cotton, 4% spandex, 60 °C washable.

Fitted sheet	90-100x 200 cm	140-160x 200 cm	180-200x 200 cm
21 white	10068744	10068745	10068746
22 ecru	10068747	10068748	10068749
23 sand	10069294	10069295	10069296
24 brown	10069297	10069298	10069299
25 anthracite	10069300	10069301	10069302
Pc. €	17,99	29,99	34,99

Jersey fitted sheets

In numerous colors and three adaptable sizes: all fitted sheets in best hotel quality, very durable and suitable for every season. They convince due to fast covering, optimal fit, are boil-proof and chlorine resistant and dry quickly. Base height 25 cm.

Material: Jersey (non-iron): 100% cotton. 95 °C washable, chlorine resistant.

Fitted sheet	90-100x 200 cm	140-160x 200 cm	180-200x 200 cm
26 white	10085798	10085799	10085800
27 ecru	10085801	10085802	10085837
28 sand	10087285	10087286	10087287
29 peach	10087300	10087301	10087302
30 lemon yellow	10087318	10087319	10087320
31 cobalt	10087309	10087310	10087311
32 yellow	10087288	10087289	10087290
33 red	10087327	10087328	10087329
34 light blue	10087303	10087304	10087305
35 green	10067703	10067704	10067705
36 anthracite	10067706	10067707	10067708
37 brown	10087383	10087384	10087385
Pcs./pack	2	1	1
Pack €	19,99	-	-
Pc. €	-	14,99	17,99

Bedding & Accessories



NEW

Mattress protector
FLAMEPROOF, from
69⁹⁹

- Flame-retarding
- Suitable for allergy sufferers
- 95 °C washable
- Breathable

1

Mattress protector FLAMEPROOF

Reliable protection against all liquids. Flame-retarding according to BS 7175 Crib 7, IMO Part 9. Perfect sleeping climate: Moisture- and thermo-regulating, breathable. Easy to put on with all-round elastic band. Pleasant grip. Boil-proof. Fast-drying.

Surface: 52% viscose (Lenzing FR), 48% lyocel (Tencel).

Underside: Polyurethane film.

95 °C washable.

FLAMEPROOF cm	Ref.	Pc. €
90x200	30003521	69,99
100x200	30003516	69,99
1 140x200	30003517	79,99
160x200	30003518	89,99
180x200	30003519	99,99
200x200	30003520	114,-

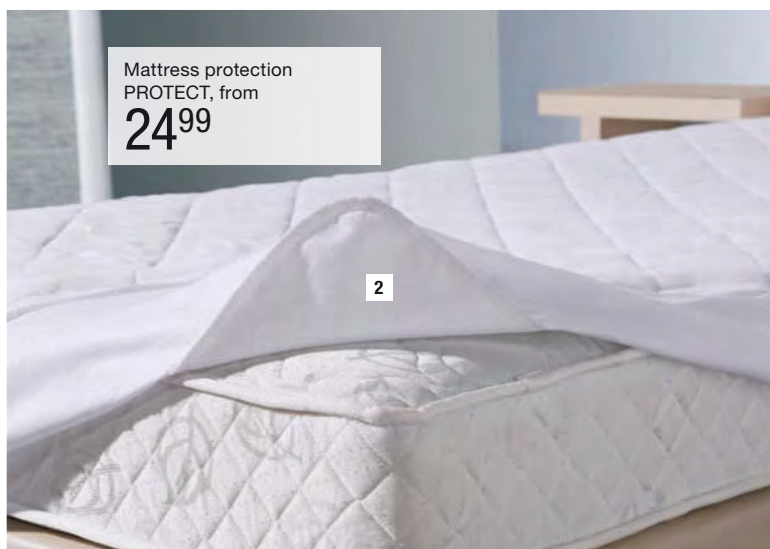

Mattress protection
PROTECT, from
24⁹⁹

2

- Protection against liquids
- For mattresses up to 22 cm height
- 95 °C washable

Mattress protector PROTECT

Waterproof terry fitted sheet with a pleasantly soft bed surface. The white terry surface is made of 80% cotton and 20% polyester. The fabric is coated on the inside. This coating is impermeable to water, but breathable.

Material: Surface 80% cotton, 20% polyester.

Underside: PVC coated, 95 °C washable. Dimensionally stable and boil-proof with all-round elastic band.

2 PROTECT cm	100x200	140x200	160x200
white	10054659	10003169	10003170
Pc. €	24,99	34,99	37,99



Mattress protection
PRYA, from
19⁹⁹

3

- Fleece
- Antibacterial
- Water-repellent and breathable

Mattress protector PRYA

Hygiene and quality are top priorities with this product. Our protective covers are made of a high-quality disposable material, thus they are repellent to mites, bacteria and pollutants. At the same time, this material is breathable and water-repellent. Extend the life of your bedding while reducing your cleaning costs.

Disposable item, please do not wash.

3 PRYA cm	90x200	140x200	160x200
white	10016909	10016910	10016911
Pack of 10	19,99	22,99	24,99
white	10016925	10016926	10016927
Pack of 50	94,99	109,99	119,99



VEGA offers you six kinds of mattress protection:

■ Flame-retarding (FLAMEPROOF)

The mattress protection FLAMEPROOF is flame-retarding according to BS 7175 Crib 7 (IMO Part 9) and thus complies with the strictest safety standards. It consists of blended fabric (viscose (Lenzing FR) and lyocel (Tencel)), reduces the felt heat, lets the air circulate and the body moisture escape.

■ Permanent (PROTECT)

This mattress protection provides permanent protection for your mattress and ensures greater hygiene and comfort. With its terry surface and polyurethane underside it is impermeable to water, but at the same time allows the air to circulate

Mattress protector DELPHINE

This product is made of brushed fleece in combination with polyurethane and offers many advantages: natural barrier against mites, reduces the risk of allergies, responds and absorbs moisture during sleep.

Material: 65% cotton, 35% polyurethane. 230 g/m². 95 °C washable.

DELPHINE			
cm	90x200	140x200	160x200
4 Sheet with elastic straps	10002651	10002652	10031957
Pc. €	19,99	24,99	26,99
5 Fitted sheet	10002654	10068329	10031954
Pc. €	24,99	29,99	32,99



Fitted sheet



Sheet with elastic straps

Mattress protector CELINE

Extremely flexible: Mattress protection made of cotton with an incorporated foil for a perfect moisture protection. Bio-Pruf® treated, therefore antibacterial, anti-allergic and breathable. Suitable for mattresses up to 23 cm height. Available in 2 versions.

Material: 75% cotton, 25% polyester, 95 °C washable.

CELINE		
cm	90x200	100x200
6 Sheet with elastic straps	30003065	30003051
Pc. €	19,99	22,99
7 Fitted sheet	30003066	30003052
Pc. €	22,99	24,99

CELINE			
cm	140x200	160x200	180x200
6 Sheet with elastic straps	30003055	30003057	30003059
Pc. €	24,99	27,99	29,99
7 Fitted sheet	30003056	30003058	30003060
Pc. €	26,99	29,99	32,99

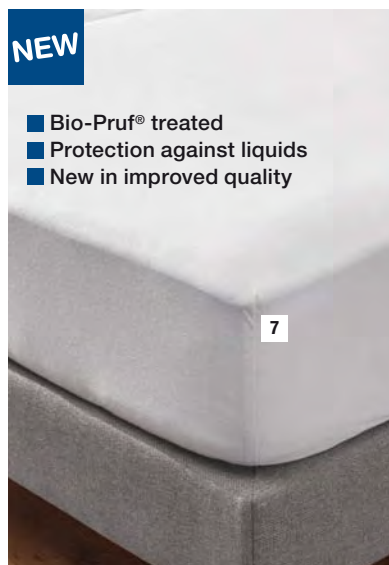

Fitted sheet

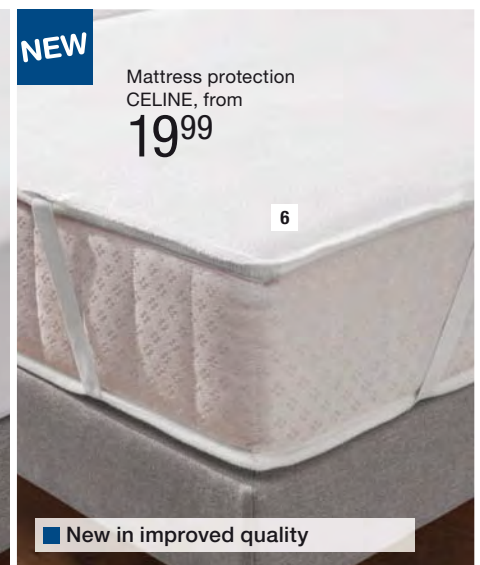

Sheet with elastic straps

Mattress protector BRICE

This mattress protector is comfortable, soft and extremely durable. It is made of cotton with an additional elastic band for a perfect fit. Suitable for mattresses up to a height of 23 cm.

Material: 100% cotton (195 g/m²). 95 °C washable.

BRICE			
cm	90x200	140x200	160x200
8	10002655	10068330	10031945
Pc. €	19,99	24,99	26,99



■ **Half permanent (PRYA)**

This mattress protection extends the durability of your mattresses. It is made of disposable material and offers all advantages of an effective mattress protector: it is impermeable to water, antibacterial and breathable. The mattress protector is not washable and must be replaced every six to twelve months.

■ **Polyurethane impregnation (DELPHINE)**

With its two sides made of terry or polyurethane, it is a natural protection against mites and thus reduces the risk of allergies. It also lets the air circulate and escape the body moisture.

■ **Polypropylene and polyethylene impregnation (CELINE)**

With its two sides made of cotton and polyester, this mattress protector offers a very effective impregnation. A film made of polypropylene and polyethylene makes it completely impermeable to water, but at the same time allows the air to circulate and moisture to escape.

■ **Cotton (BRICE)**

Both sides of this mattress protector are made of cotton. This provides maximum moisture absorption and protects your entire bed.



Please call us at
+49 8272 807 447



Worldwide
delivery



Please visit us at
www.em-group.com



- Water-repellent
- Breathable
- Antibacterial

Protective pillow covers PRYA

This product has its priority at hygiene and quality. Our protective covers are made of a high-quality disposable material, thus they are repellent to mites, bacteria and pollutants. At the same time, this material is breathable and water-repellent. Extend the life of your bedding while reducing your cleaning costs.

Disposable item, please do not wash.

PRYA	80x80	80x80
1 white	10016920	10016936
Pack of 10	12,99	-
Pack of 50	-	59,99



- Protection against liquids
- Breathable

Protective pillow covers PROTECT

With zipper in the usual sizes. The white terry surface is made of 80% cotton and 20% polyester. The fabric is coated on the inside. This coating is moisture impermeable, but breathable.

Material: Surface 80% cotton, 20% polyester. Underside PVC coated, 95 °C washable.

PROTECT	40x80	60x80	80x80
2 white	30014301	10054660	10054661
Pc. €	7,99	9,99	12,99



VEGA offers two kinds of protective pillow covers:

■ **Semipermanent (PRYA)**

This protective cover extends the life of your pillow at a low price. It is made of disposable material and offers all benefits of an effective cushion protection: It is impermeable to water, antibacterial and breathable, and also very comfortable. The protective covers are not washable and must be replaced every six to twelve months.

■ **Permanent (PROTECT)**

This protective cover provides a long-lasting protection of your pillows and provides greater hygiene and comfort. With its terry surface and polyurethane underside it is impermeable to water, but at the same time it allows the air to circulate.

- 80% feathers, 20% down
- Suitable for allergy sufferers, with Nomite certificate



Pillows APOLLO

Filled with white new down and feathers, class 1. The cover made of fine cotton fabric with satin piping is wonderfully skin-friendly and soft. NOMITE mite- and down-proof ticking with the down pass. For comfortable sleeping. You will receive the pillow in a practical storage bag. Quality made in Germany.

Filling: 80% white new feathers, 20% white new down.

Cover: 100% cotton, twill with tuck. 60 °C washable, Tumble drying required. Do not chlorinate.

APOLLO		
cm	40x40	40x80
Filling in g	240	550
3 white	10061992	10061991
Pc. €	17,99	24,99
APOLLO		
cm	60x80	80x80
Filling in g	750	950
3 white	10061638	10051423
Pc. €	29,99	34,99



- 60% down, 40% feathers
- Suitable for allergy sufferers



Pillows HYPNO

Filled with white new down and feathers, with cover made of twill with satin tuck. Wonderfully soft and skin-friendly. NOMITE mite- and downproof ticking with down pass. The high-quality pillows are delivered in a practical storage bag. Quality made in Germany.

Filling: 60% white new down, 40% white new feathers.

Cover: 100% cotton, twill with satin tuck. 60 °C washable, tumble drying required.

HYPNO			
cm	40x80	60x80	80x80
Filling in g	480	640	800
4 white	10067507	10067506	10067462
Pc. €	37,99	44,99	59,99



Natural filling

A natural filling not only guarantees authenticity and volume, but also optimally supports the body and ensures an excellent sleeping. The filling consists either completely of duck down or may additionally contain duck feathers. Down impresses above all through lightness and volume. Since down is less common than feathers, a pure down pillow is always a very special product. The feathers give the pillows strength. The higher the share of feathers, the stronger the pillow. And the

higher the share of down, the softer it is. A natural filled pillow can be machine washed. In addition, it is recommended to shake the pillows regularly, so that down and feathers can be optimally distributed. You can increase the hygiene and lifespan of your pillows by protecting them from sweat with our protective covers (see opposite page).



Please call us at
+49 8272 807 447



Worldwide
delivery



Please visit us at
www.em-group.com



Pillows
YUKON, from
17.99

1

■ Cover made of cotton satin

>Duvet YUKON can be found on page 65.



All beddings of our range
can be found on

www.em-group.com



Pillows YUKON

Top quality for connoisseurs! In this pillows, your guests feel like they are in paradise. Filling and cover are noticeably high-quality. Due to the high bulk volume and the breathable filling in top quality, a temperature compensating effect is achieved. Individual adjustment of the filling quantity by zipper.

Filling: 100% polyester, super siliconized top hollow fiber.

Cover: 100% cotton satin, white, shiny. 60 °C washable. Tumble drying possible.

YUKON	40x80	60x80	80x80
cm	400	600	800
Filling in g	400	600	800
1 white	10036233	10036234	10036235
Pc. €	17,99	19,99	24,99



- Boil-proof
- Chemical cleaning possible
- For house dust mite allergy sufferer

Pillows
PROFIWASH, from
8.99

2

>Duvet PROFIWASH can be found on page 65.



Pillows PROFIWASH

Meets even the highest hygiene requirements. This pillow meets the quality standard of laundries and health care. It is also especially recommended for house dust mite allergy sufferers, since it is washable at 95 °C.

Filling: 100% polyester hollow fiber, quilted, inside 100% PU sticks.

Cover: 65% polyester, 35% cotton.

95 °C washable. Tumble drying and chemical cleaning possible.

PROFIWASH	40x40	40x80	60x80	80x80
cm	200	400	600	800
Filling in g	200	400	600	800
2 white	10036189	10036190	10036191	10036192
Pc. €	8,99	16,99	19,99	24,99



- Cover made of microfiber
- Easy-care

Pillows
DREAM, from
6.99

> Duvet DREAM can be found on page 65.



Pillows DREAM

Easy-care, hygienic and inexpensive, an ideal alternative to conventional beddings. Filling and cover are noticeably high-quality. The super siliconized hollow fiber ensures moisture transport and is very easy to care for. The checked single quilting with round roll guarantees perfect fit of the content.

Filling: 100% polyester hollow fiber, Cover: 100% polyester, microfiber. 60 °C washable. Tumble drying possible.

DREAM	Pillows			
cm	30x50	40x40	40x60	40x80
Filling in g	180	200	400	400
3 white	10036745	10047815	10048158	10047813
Pc. €	6,99	6,99	7,99	9,99
DREAM	Pillows			Bolster
cm	50x50	60x80	80x80	15x40
Filling in g	350	600	800	270
3 white	10036740	10045248	10045247	10071104
Pc. €	7,99	10,99	13,99	6,99



Duvets and pillows

Care

Our duvets and pillows are good for your health, anti-allergic and easy-care. They can be machine washed and tumble dried at moderate temperatures (40 °C - 60 °C).

Cover

Our covers are soft, thin and lightweight. As they are woven very densely, the filling is preserved for a long time and mites are kept away.

Quilting

With a diamond- or upholstery quilting, the fibers are optimally distributed.

The different fillings

■ **Super siliconized hollow fiber filling.**
Due to the silicone the fibers are smooth and do not lump. They are equally distributed in the duvet or pillow.

■ **Natural filling**

Feathers and down support the body and provide an excellent sleeping environment. The down flakes allow good air circulation and moisture absorption. Furthermore, they

make duvets and pillows fluffy and comfortable. The feathers have a two-dimensional structure and a higher weight. This makes duvets and pillows firm and robust.

Our pillows and duvets comply with standard EN ISO 12952.



Please call us at
+49 8272 807 447



Worldwide
delivery



Please visit us at
www.em-group.com



Duvet APOLLO, from **89⁹⁹**

- Ideal for the whole year
- 60% down and 40% feathers
- Suitable for allergy sufferers, with Nomite certificate



Duvet APOLLO

This covered duvet spoils with a pleasant sleeping comfort during the whole year. With normal bedroom temperature and normal heat requirements, you are in the right place with the blanket during the whole year. Filled with white new down and feathers, class 1. The cover, which is made of a fine cotton fabric with satin piping is wonderfully skin-friendly and soft. NOMITE mite- and down-proof ticking, with down pass.

Filling duvet: 60% white new down, 40% white new feathers. Cover duvet: 100% cotton, fine cotton fabric. 60 °C washable, tumble drying required. Do not chlorinate.

APOLLO	1 Duvet		
cm	135x200	155x220	220x240
Filling in g	740	930	1450
white	10046433	10046434	10003150
Pc. €	89,99	139,-	230,-



- High-quality filling made of 100% down
- Optimized filling for better sleeping comfort
- Suitable for allergy sufferers, with Nomite certificate

Duvet HYPNO, from **149⁰⁰**



Duvet HYPNO

Filling made of white new down and feathers, class 1. The individual cassettes are closed by 2 cm high bases and thus prevent slipping of the filling. Therefore, no cold spots appear and the heat can be distributed equally. Cover - a fine down batist. Wonderfully soft and skin-friendly. NOMITE mite- and downproof inlet - new with downpass. The blanket is washable up to 60 °C and thus ideal for house dust allergy sufferers. Delivery in a practical storage bag. Quality made in Germany.

Filling: 100% white new duck down. Cover: 100% cotton, fine down batiste. 60 °C washable. Tumble drying possible. Also available as summer duvet.

HYPNO	2 Duvet all-year-round quality	
cm	135x200	155x220
Filling in g	690	870
white	10067440	10067441
Pc. €	149,-	209,-

HYPNO	2 Duvet all-year-round quality	
cm	240x220	
Filling in g	1470	
white	10068173	
Pc. €	299,-	

HYPNO	2 Duvet summer quality	
cm	135x200	155x220
Filling in g	240	300
white	10088009	10088010
Pc. €	89,99	129,-

i

Natural filling

A natural filling not only guarantees authenticity and volume, but also optimally supports the body and ensures an excellent sleeping climate. The filling either completely consists of duck down or may contain duck feathers. Down impresses above all through lightness and volume. Since down is less common than feathers, a pure down duvet is always a very special product. The feathers provide strength in a duvet. The higher the share

of feathers, the firmer the duvet. And the higher the share of down, the softer it is. A duvet with natural filling can be machine washed. In addition, it is recommended to shake the duvet regularly so that down and feathers can be optimally distributed.



- Easy-care
- Good moisture transport

Duvet DREAM

Easy-care, hygienic and inexpensive, an optimal alternative to conventional bedding. Filling and cover are noticeably high-quality. The super siliconized hollow fiber ensures moisture transport and is very easy to clean. The checked single quilting with round roll guarantees a perfect fit of the content.

Filling: 100% polyester hollow fiber, Cover: 100% polyester. 95 °C washable, tumble drying and chemical cleaning possible.

DREAM	3 Duvet	
cm	135x200	155x220
Filling in g	1000	1200
white	10045246	10036187
Pc. €	29,99	39,99

DREAM	3 Duvet	
cm	155x200	220x240
Filling in g	1100	1950
white	10036186	10016078
Pc. €	34,99	49,99

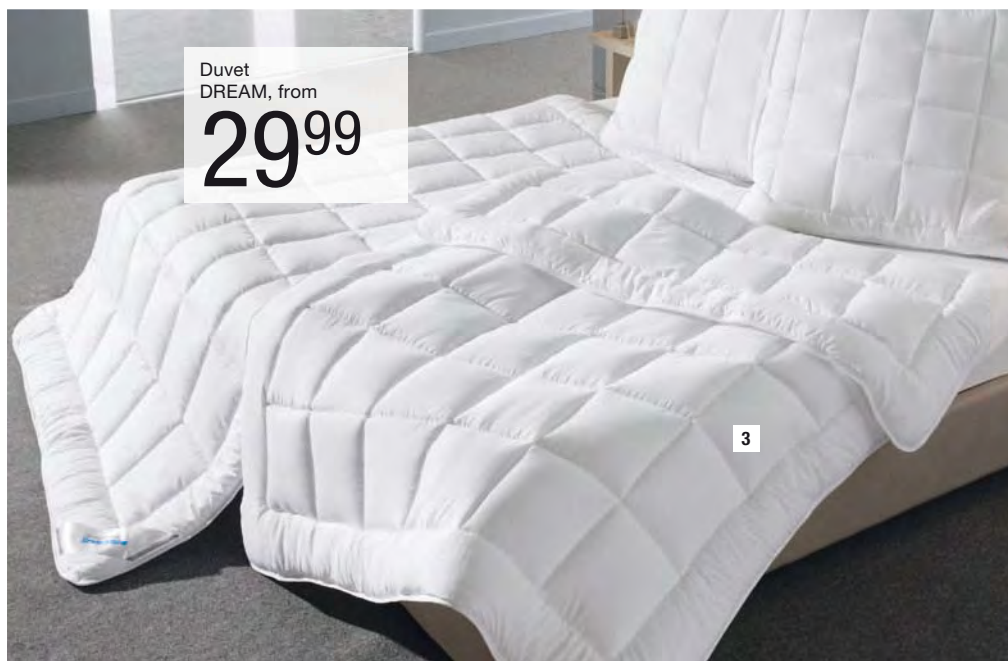

- Boil-proof
- Chemical cleaning possible



Duvet PROFIWASH

Meets even the highest hygiene requirements. This bedding complies with the quality standard of laundries and health care. It is especially recommended for house dust mite allergy sufferers, because it is washable at 95 °C. Also available in child's bed size.

Filling: 100% polyester super siliconized hollow fiber. Cover: 65% polyester, 35% cotton. 95 °C washable, tumble drying and chemical cleaning possible.

PROFIWASH	4 Duvet		Child's bed
cm	135x200	155x220	100x135
Filling in g	1000	1200	500
white	10036193	10036195	10028513
Pc. €	39,99	54,99	24,99

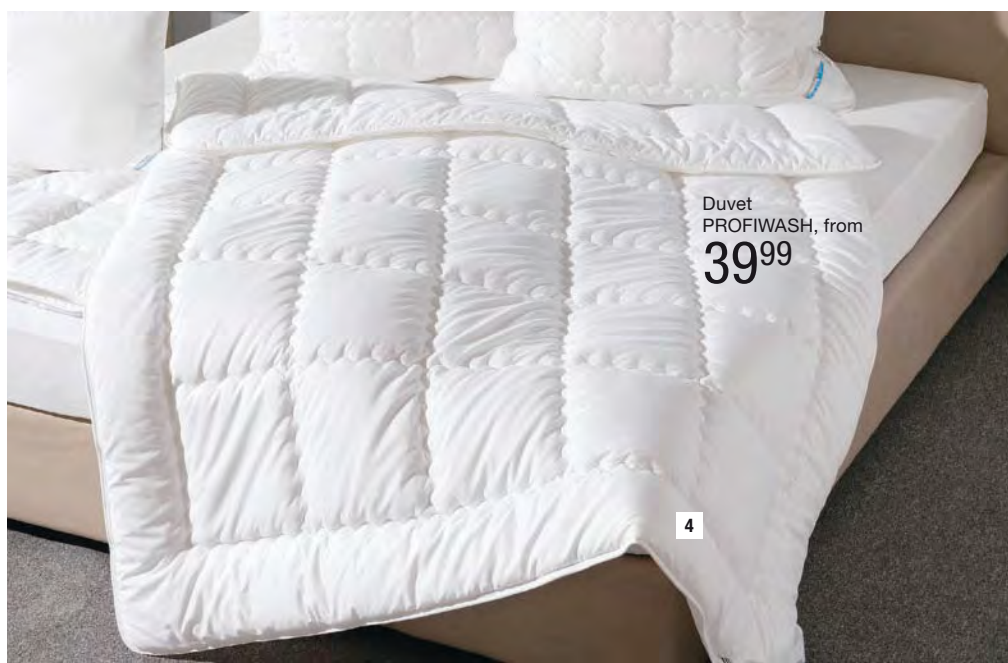

- Breathable
- High bulk volume



Duvet YUKON

Top quality for connoisseurs! In this bed your guests feel like in paradise. Filling and cover are noticeably high-quality. Due to the high bulk volume and the high-quality breathable filling, a temperature compensating and warming effect is achieved.

Filling: 100% polyester, super siliconized top hollow fiber. Cover: 100% cotton satin, white, polished. 60 °C washable, tumble drying and chemical cleaning possible, do not chlorinate.

PROFIWASH	5 Duvet		
cm	135x200	155x200	155x220
Filling in g	1200	1400	1500
white	10047803	10036236	10047804
Pc. €	49,99	59,99	69,99

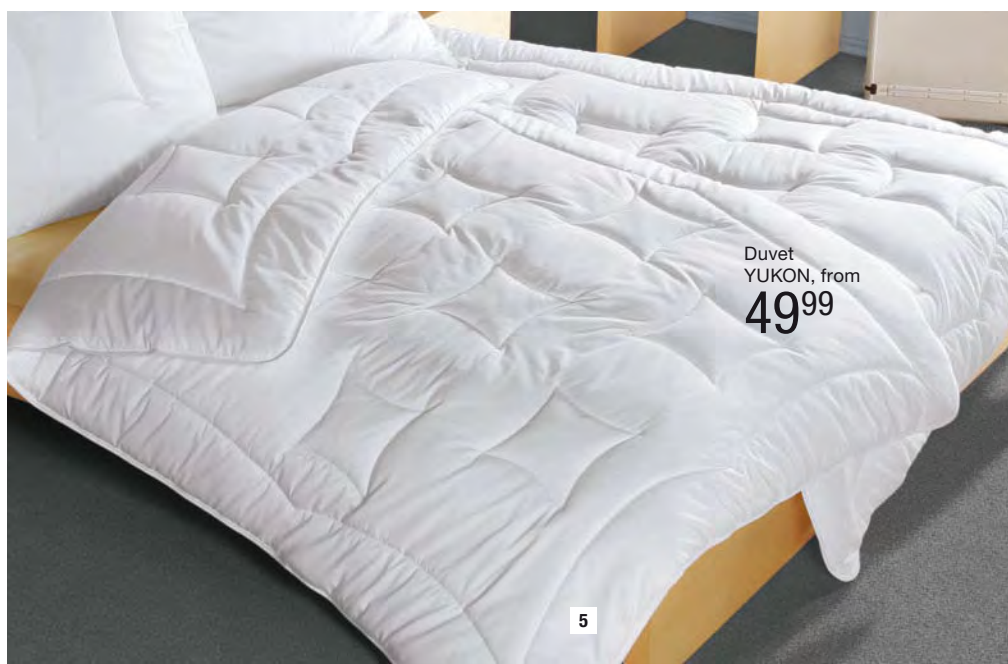

Please call us at
+49 8272 807 447



Worldwide
delivery



Please visit us at
www.em-group.com



>Coffee cup PALLAIS can be found on www.em-group.com.



Serving tray
FLAVIO 3-piece
59⁹⁹

■ Solid wood

Serving trays FLAVIO

This serving tray made of solid wood in black, oak or oak stained, consists of three modular parts: a large tray with rounded corners, a mini tray, e. g. for two cups that fit perfectly into the large tray, and an element with four small compartments in different heights, in which utensils such as small sugar bags, teabags, toothpicks, etc. can be placed.

Material: Oak natural or stained. Not dishwasher safe!

FLAVIO 3-piece		Big tray LxWxH cm	Small tray Lx-WxH cm	Box LxWxH cm	Ref.	Set €
1	oak natural	41x30,8x2,8	28,6x15,5x1,8	28,6x6,8x6	10051315	59,99
2	oak stained	41x30,8x2,8	28,6x15,5x1,8	28,6x6,8x6	10051316	59,99
3	black	41x30,8x2,8	28,6x15,5x1,8	28,6x6,8x6	10051314	59,99



>Vacuum flask IZOTERMA can be found on www.em-group.com.

■ Solid wood



Tray
ORPHEO, from
29⁹⁹

Tray ORPHEO

The timeless tray ORPHEO is a good choice in all bar and service areas. In three different sizes and with white or black inserting floor, the stable tray made of oak can be carried well with the practical handles at the side. It is very easy to clean and can be simply wiped with a damp cloth.

Material: Oak lacquered. Not dishwasher safe!

ORPHEO LxWxH in cm	Ref. oak/white	Ref. oak/black	Pc. €
30x18x5,5	4 10006229	10006232	29,99
40x25x5,5	10006230	5 10006233	39,99
50x31x5,5	6 10006231	10006234	49,99

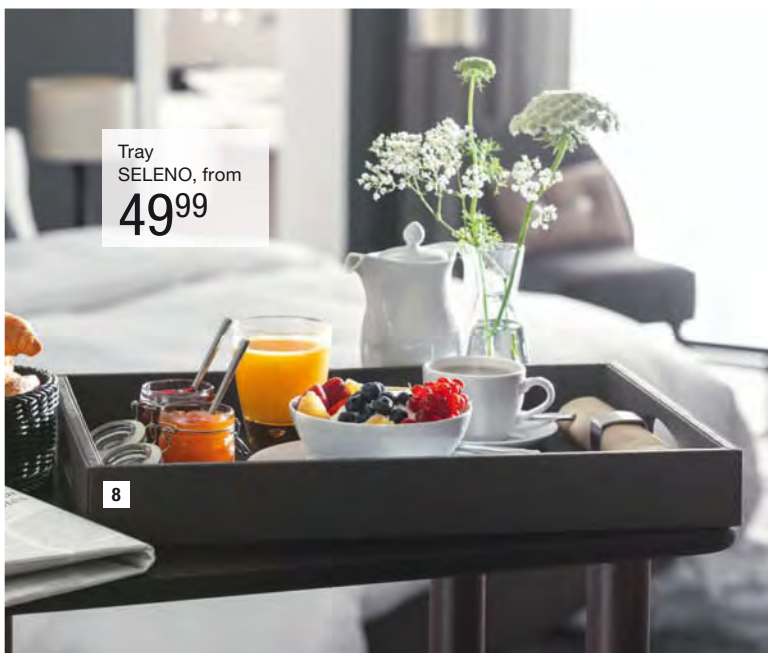

Tray
SELENO, from
49⁹⁹

■ Leather or linen look



Tray SELENO

Serve your guests small food and drinks exceptionally classy with the tray SELENO. It convinces with two practical handles at the side and the cover in leather or linen look, which completely covers the stackable wooden tray. Easy to clean - simply wipe with a damp cloth.

Material: Wood, cover: 100% polyester. Not dishwasher safe!

SELENO LxWxH in cm	Ref. black	Ref. brown	Pc. €
Leather look			
40x25x5,5	7 10006221	10006222	49,99
52x35x5,5	8 10006227	10006228	59,99
Linen look			
40x25x5,5	10006223	10006224	49,99
52x35x5,5	10006226	9 10006225	59,99

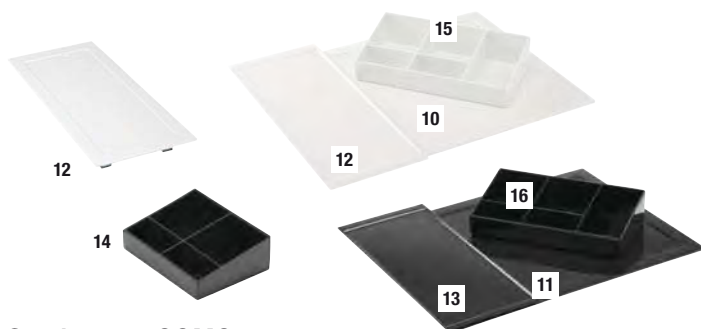

Serving tray COMO

Due to the simple and stable design these trays are universally applicable and they fit perfectly to any style of hotel room design.

Material: Melamine. Dishwasher safe! Stain repellent and scratch resistant! Customizable on request!

COMO	LxWxH in cm	Ref. ivory	Ref. black	Pc. €
Tray				
Main tray	37,7x27,8x2,5	10 10049555	11 10049546	18,99
Additive tray	29,5x15x2	12 10049557	13 10049548	7,99
Additive tray with compartments				
4 compartments	15,2x11,5x4,9	10049559	14 10049550	4,49
5 compartments	21,5x11,4x4,9	15 10049558	16 10049549	5,99



> Electric kettle RIZZA can be found on page 68.

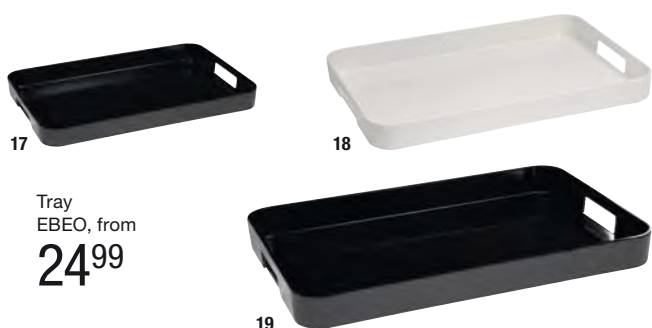

Tray EBEO, from **24⁹⁹**

Tray EBEO

In any modern or timeless ambience, the pretty and practical bar- and service trays EBEO in three sizes perform at their best. Handles at the side provide excellent grip.

Material: Melamine. Dishwasher safe!

EBEO	LxWxH in cm	Ref. white	Ref. black	Pc. €
33x26x4		10006340	17 10006339	24,99
43x29x4,5		18 10006342	10006341	29,99
53,5x34,5x5,5		10006344	19 10006343	34,99



> Vacuum flask IZOTERMA can be found on www.em-group.com.

Tray AMINA **18⁹⁹**



Tray AMINA

Melamine trays that are ideal for room service. This item is UV resistant, abrasion resistant and stain resistant. The trays are excellent for everyday use, dishwashersafe and stackable. We recommend to dry the trays before stacking. More sizes can be found on www.em-group.com.

Material: Melamine. Dishwasher safe! Customizable on request!

AMINA	LxWxH in cm	Ref.	Pc. €
20 white	60x40x1,5	10045094	18,99
21 black	60x40x1,5	10045095	18,99



> Cup series ALLEGRI COLORI can be found on www.em-group.com.



Side table
ESMA

205⁰⁰

- Solid wood
- Max. load capacity 40 kg



Side tables ESMA

The frame is made of solid beech wood, the panels are coated with a scratch-resistant melamine coating and equipped with 4 steerable wheels. The brakes on two wheels guarantee a safe parking of the side table.

Material: Solid beech, stained. 4 fully movable wheels, 2 of them with brakes! Melamine coated surface!

ESMA*	
WxDxH in cm	71x46x80
Distance between panels	45 cm
1 cherry	10094792
2 wenge	10094793
Pc. €	205,-

*Easy assembly, delivered disassembled.

NEW Electric kettle
44⁹⁹



3

Electric kettle

Electric kettle with high-quality housing made of stainless steel, heat insulating plastic handle, non-slip rubber feet, spout with sieve and heating element covered by stainless steel. Practical and pleasant one-hand operation. Safe operation and handling: overheating protection, automatic steam stop, integrated finger guard on the lid, on/off switch with indicator light. Easy to clean due to hinged lid with large opening. Water level indicator for easy reading of the water level. 360 °C central-cordless-system: Kettle can be attached wirelessly from any direction to the base of the device. 2 years warranty.

Material: Stainless steel.

Cable rewind. Power: Approx. 2200 watt. Volume approx. 1,0 l

Electric kettle	
WxDxH in cm	19x14x20,5
Content in l	1
Power	2200 W/220-240 V
3 Ref.	30014605
Pc. €	44,99

Electric kettle
TISANA

29⁹⁹



4

Electric kettle TISANA

Thanks to the separate base with integrated cable rewind, this kettle is wirelessly removable. The spout with sieve and a hinged lid with safety lock ensure safe handling. With transparent water level indicator and concealed heating element. 2 years warranty.

Material: Plastic. Cable rewind. Power approx. 1000 V.

Volume 1 l

TISANA	
WxDxH in cm	20x13,5x21,4
Content in l	1
Power	1000W/230 V
Color	white
4 Ref.	10081560
Pc. €	29,99

Electric kettle
RIZZA

18⁹⁹



Electric kettle RIZZA

This kettle is wirelessly operated due to the separate base. The lid of the device is equipped with a safety lock and the automatic steam stop and overheating protection make handling not only easy, but also safe. With transparent water level indicator on both sides. 2 years warranty.

Material: Plastic. Cable rewind. Power approx. 1000 W.

Volume 1 l

RIZZA	Content in l	Ref.	Pc. €
Power 230 V/1000 W, WxDxH 18x13x23 cm			
5 beige	1	10081363	18,99
6 black	1	10081441	18,99



5

6



7



Minibar

This mini bar is noiseless due to the latest technology, well insulated and keeps drinks cool for your guests. It has an automatic defrost and a rotary switch and is equipped with an interior lamp (LED). Delivered with 1 grid and 2 door inserts. CFC-free. Door hinges are changeable! Temperature adjustable from approx. 3 °C - 12 °C! 2 years warranty!

Minibar		7
WxDxH in cm	38,4x41,2x52,2	40,1x45,3x55,4
Content in l	26	36
Power	0,065 kW/220-240 V	0,065 kW/220-240 V
Efficiency class	D	D
Color	black	black
Weight in kg	13,5	14,5
Ref.	10040281	10080281
Pc. €	199,-	219,-



- Noiseless
- Automatic defrost

Minibar, from
199⁰⁰

7



NEW

9

Room safe SECURO

With this room safe you not only offer your guests a decisive piece of comfort and safety, but also a good quality of hardened steel. Just as important are the ease of use and reliable trouble-free operation. For emergencies there are 2 emergency opening keys as well as the master code. The safe with the dimensions 44,5x38x20 offers enough space for laptops up to 15 inches and the safe with the dimensions 40x41x19,5 for laptops up to 17 inches. Drill holes are provided on the bottom and back of the safe - mounting material included. Battery operated, batteries not included in the scope of delivery. With LED display.

- Big display

Room safe
SECURO, from
119⁰⁰



8

SECURO	8 Content 21 l	9 Content 28 l
LxWxH in cm outside	44,5x38x20	40x41x19,5
LxWxH in cm inside	43,2x32,5x19	38,7x35,5x18,5
Fitting for	Laptops 15"	Laptops 17"
Battery	4xAA-6-V	4xAA-6-V
Color	black	black
Weight in kg	15,7	15,2
Ref.	30001727	30001726
Pc. €	119,-	129,-

Waste bin
14⁹⁹



10

Waste bin

Made of stainless steel. With removable insert made of plastic. Not fireproof.

Waste bin	Content in l	ØxH in cm	Ref.	Pc. €
10 silver	8 l / Insert 5 l	20,6x27	10006090	14,99

Waste bin with
stainless steel
ring
20⁹⁹



11



12

Waste bins with stainless steel ring

Noble waste bin made of sturdy ABS plastic and solid stainless steel ring. Not fireproof.

Waste bin	Content in l	ØxH in cm	Ref.	Pc. €
11 black	6,4	19,4x25	10029481	20,99
12 grey	6,4	19,4x25	10029806	20,99

NEW



Clothes hanger
PERCIO, from
2,99



■ Exclusive design



Clothes hanger PERCIO

Really good service can be seen in the details. The best example are our high-quality clothes hangers PERCIO. They have a trouser bar as well as two hooks for comfortable hanging of skirts and are available in the two colors taupe and anthracite. The shoulder area is 3 cm. The silver-colored hook in the variant without anti-theft device measures Ø 37 mm. At the model with anti-theft device measures Ø 32 mm. (Hook fig. 5 please order separately).

Material: Plastic.

PERCIO	LxH in cm	Ref.	Pcs./pack	Pack €	=Pc. €
anthracite					
1 without anti-theft device	45,5x16,7	30001416	12	35,88	2,99
2 anti-theft device	45,5x17,9	30001417	12	35,88	2,99
taupe					
3 without anti-theft device	45,5x16,7	30001418	12	35,88	2,99
4 anti-theft device	45,5x17,9	30001419	12	35,88	2,99
Hook for anti-theft device (please order separately)					
5 suitable for Ref. 30001417 and 30001419	Ø 3,2	30001420	12	11,88	0,99



Clothes hanger, from

1,19

■ Soft touch surface

8, 9, 12, 13

Clothes hanger

Available in different versions. The metal ring on the hangers with anti-theft device has a diameter of 38 mm.

Material: Wood.

Customizable on request!

Clothes hanger	Ref.	Pcs./pack	Pack €	=Pc. €
With non-slip bar – LxH 44,5x23 cm				
6 natural	10081900	24	28,56	1,19
7 mahogany	10081909	24	33,36	1,39
8 grey – soft touch	10081904	12	25,08	2,09
9 black – soft touch	10081906	12	25,08	2,09
With non-slip bar and anti-theft device – LxH 44,5x27 cm				
10 natural	10081901	12	15,48	1,29
11 mahogany	10081910	12	17,88	1,49
12 grey – soft touch	10081905	12	26,28	2,19
13 black – soft touch	10081907	12	26,28	2,19

Spare ring
pack of 6
1,39



Clothes hanger	Ref.	Pcs./pack	Pack €	=Pc. €
With wire bar and two clips – LxH 44,5x27 cm				
14 natural	10081902	12	20,28	1,69
15 mahogany	10081911	12	22,68	1,89
With wire bar, anti-theft device and two clips – LxH 44,5x31 cm				
16 natural	10081903	12	21,48	1,79
17 mahogany	10081912	12	23,88	1,99
Spare ring for anti-theft device, suitable for Ref. 10081901, 10081903, 10081905, 10081907, 10081910, 10081912				
18	10081908	6	1,39	–

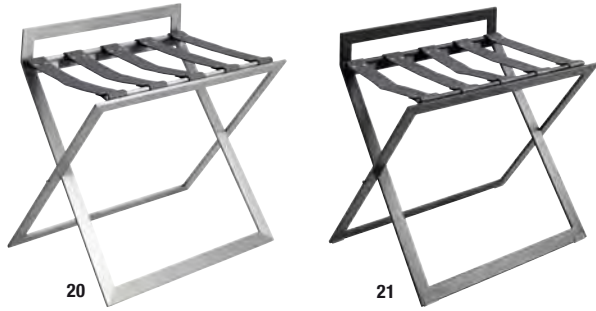

20

21



Suitcase stands BAGAGIO

The extremely stable suitcase stand BAGAGIO is made of a sturdy stainless steel frame and high-quality riveted imitation leather strips. It can withstand loads of up to 50 kg, can be folded for a space-saving storage and protects your walls due to the integrated wall protection strip, as well as your floors are protected by glides on the bottom of the legs.

BAGAGIO	WxDxH in cm	Ref.	Pc. €
20 stainless steel with brown leather straps	46x70x64,5	10006572	89,99
21 stainless steel with anthracite leather straps	46x70x64,5	10006573	89,99
22 anthracite powder-coated with anthracite leather straps	46x70x64,5	10006574	89,99



Suitcase stand
BAGAGIO
89⁹⁹

19

- Exclusive design
- Foldable
- Floor friendly
- With wall protection strip



22

23

- Solid wood
- Foldable



Suitcase stands VALIGIA

Made of birch wood, indispensable in every guestroom. Provided with hard-wearing black straps as a gentle luggage rack as well as flap mechanic for space-saving storage. Max. load capacity 50 kg.

VALIGIA	WxDxH in cm	Ref.	Pc. €
Weight 2,5 kg			
22 cherry	65x36x51	10089439	46,99
23 mahogany	65x36x51	10089440	46,99
24 walnut	65x36x51	10089441	46,99



Suitcase stands
VALIGIA
46⁹⁹

24



25

26

- Foldable



Suitcase stands CASEA

Made of steel pipe, indispensable in every guestroom. Provided with hard-wearing black straps as a gentle luggage rack as well as flap mechanic for space-saving storage. Max. load capacity 50 kg.

CASEA	WxDxH in cm	Ref.	Pc. €
Weight 2,2 kg			
25 mirror polished chromed	56x68x53	10091900	32,99
26 black	56x68x53	10094601	32,99



25

Suitcase stands
CASEA
32⁹⁹

Accessories

Door signs
pack of 5

6⁴⁹



Door signs
pack of 10

4⁹⁹



Door signs

Both sides are imprinted in 4 languages (EN/DE/FR/ES) with PLEASE DO NOT DISTURB / PLEASE CLEAN UP MY ROOM.

Material: Imitation leather.

Door signs	LxW in cm	Ref.	Pcs./pack	Pack €
1 brown	24x8	10053005	5	6,49
2 grey	24x8	10053004	5	6,49
3 bordeaux/green	24x8	10053006	5	6,49

Door signs

Both sides are imprinted in 4 languages (EN/DE/FR/ES) with PLEASE DO NOT DISTURB / PLEASE CLEAN UP MY ROOM.

Available in 2 different formats and designs fitting to the style of your house.

Material: Cardboard.

Door signs	LxW in cm	Ref.	Pcs./pack	Pack €
4 square	23,8x7,8	10053077	10	4,99
5 round	24x8,4	10053076	10	4,99

Table display

5¹⁹



Table display

With this exclusive table display made of anodized aluminum, your customers are discreetly and unobtrusively provided with information. The stable displays with a material thickness of 4 mm are engraved on both sides.

Material: Aluminum, anodized.

Table display	Ref.	Pc. €
6 WxH 5x4 cm	10044091	5,19

Table display
pack of 10

4⁷⁹

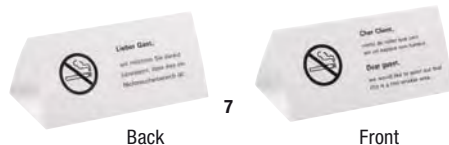

Table display

For versatile use in your various non smoking areas. This display is printed on both sides and in 3 languages (DE/EN/FR).

Material: Paper.

Table display	BxH in cm	Ref.	Pcs./pack	Pack €
7	11,1x5,5	10053079	10	4,79

Door sign

1⁹⁹



18/10

Door sign

Ideal for individual marking of your guest rooms. The full-length self-adhesive back ensures quick and easy installation.

Material: Chrome-nickel stainless steel 18/10.

Door signs	Ø in cm	Ref.	Pc. €
8 Men	7,4	10049907	1,99
9 Women	7,4	10049908	1,99
10 Women/Men	7,4	10049909	1,99
11 Wheel chair	7,4	10049927	1,99
12 No smoking	7,4	10049928	1,99

Shoe polishing machine

79⁹⁹



CE

Shoe polishing machine

With this electric shoe polishing machine you offer your guests a useful service which will gladly be used. The extremely compact design finds space almost anywhere. It can be used comfortably via a foot on/off switch and is of course equipped with a removable rubber mat, which absorbs the brushed off dirt. 2 years warranty.

Foot on/off switch!

Shoe polishing machine	Ref.	Pc. €
13		
WxDxH in cm	40x24x25,8	
Brushes ØxW in cm	14x5,3	
Power	0,12 kW/230 V	
Weight in kg	7	
Ref.	10081364	
Pc. €	79,99	
Shoe cream	Ref.	Pc. €
colorless, 1 l	10093364	29,99
Spare brushes	Ref.	Pc. €
Pre-cleaning brush	10093224	9,99
Cleaning brush	10093225	9,99

Coat rack
YARA
89⁹⁹



14

Coat rack YARA

Stable, extremely practical and an eye-catcher at the same time. Best workmanship, stained and lacquered made of dimensionally stable beech wood. We deliver this beautiful piece of furniture disassembled in three parts - the assembly is very easy!

Material: Solid beech, stained.

YARA	WxDxH in cm	Ref.	Pc. €
Weight 4,5 kg			
14 walnut dark	43x40x184	10090225	89,99

Coat racks
APENDIO, from
289⁰⁰



15

16

Coat racks APENDIO

This functional coat rack combines high quality and timeless design. Very stable and sturdy thanks to a steel base plate. It has 20 hooks and an umbrella stand made of high-quality stainless steel. Delivered in kit, easy assembly.

Material: Oak natural or tobacco stained, combined with stainless steel.

APENDIO	Ref.	Pc. €
WxDxH 50x50x180 cm, Weight 32 kg		
15 oak	30001698	289,-
16 tobacco	30001699	299,-



■ Integrated umbrella stand
■ Solid wood

16



Dust control mat

These dust control mats with their absorbent polypropylene surface keep your entrance area clean. With coated rubber back and all-round impact edge, they are absolutely non-slip. More colors on www.em-group.com.

Material surface: 100% polypropylene. 30 °C washable. Easy cleaning with vacuum cleaner. Non-slip! Only suitable for indoor and protected outdoor areas!

Dust control mats	Ref. 60x90 cm	Ref. 90x120 cm	Ref. 120x180 cm	Ref. 120x300 cm
17 red	10027064	10027065	10027066	-
18 bordeaux	20090706	20090709	20090713	-
19 grey	20090395	20090396	20090711	20090399
Pc. €	22,99	39,99	63,99	115,-

Dust control mat, from
22⁹⁹

■ Strongly absorbent
■ Non-slip

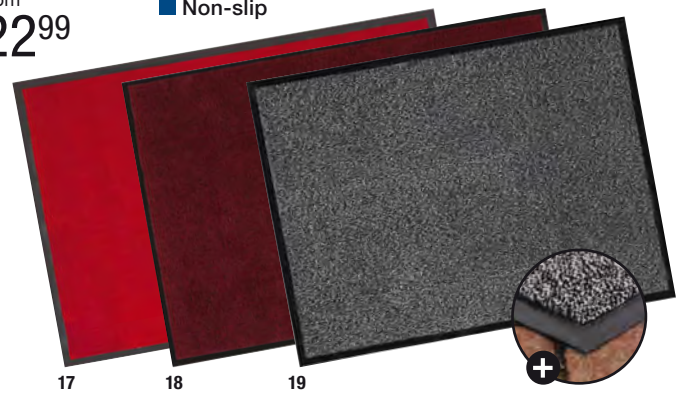

17

18

19



Vacuum cleaner

With plastic housing. Delivered with chromed steel pipe and extensive accessories. Only suitable for vacuuming dry residues. Please also order our vacuum cleaner bags in set of 10. 2 years warranty.

Exhaust filter! Cable hanger! Electric indicator for bag change! Foot on/off switch!

Vacuum cleaner	20
WxDxH in cm	34x41x39
Power	1,2 kW/230-240 V
Weight	7 kg
Bag capacity in l	6
Volume in dB	61
Hose length in m	2,20
Cable length in m	9,50
Ref.	10081154
Pc. €	199,-
Vacuum cleaner bag	
Pcs./pack	10
Ref.	10081156
Pack €	12,90

Vacuum cleaner
199⁰⁰



20

General Terms and Conditions

1 Scope and provider

These General Terms and Conditions apply to all orders you place with E.M. Group International GmbH, Hettlinger Straße 9, 86637 Wertingen, represented by its managing director, Siegfried Horn.

Service hotline: Mon to Thu 07.30 am – 05.00 pm, Fri 07.30 am – 03.30 pm, phone: +49 8272 807 447, fax: +49 8272 807 451, e-mail: service@em-group.com, online-shop: www.em-group.com.

Our goods are exclusively offered to commercial consumers. Our deliveries, services and offers are provided exclusively on the basis of these General Terms and Conditions which shall also apply to all future business relationships even if they are not expressly agreed again. Your or any third party's terms and conditions of business shall not apply even if we do not object to their application in a particular case.

The contract language shall only be German or English.

You can access and print out our currently valid General Terms and Conditions at the following website: www.em-group.com.

2 Conclusion of contract

The presentation of goods in the online shops, catalogues and advertisements shall not be binding offers to conclude a purchase agreement. Rather, such presentation shall represent a non-binding invitation to order goods by phone, fax, e-mail or online.

Upon receipt of your order, we shall check whether the articles ordered are available and we shall then make an individual offer which you may accept in writing or by paying the purchase price. We shall be bound to our offer for a period of 14 days.

A purchase agreement for the goods or services shall be concluded only if you pay the amount stated in the offer or expressly accept our offer in writing. Sending an e-mail shall be sufficient as written acceptance.

3 Prices

Prices apply to the extent of delivery and services stated in our individual offer. Prices are quoted in EURO ex works, plus packaging and shipping charges and, where applicable, plus statutory value-added tax. Customs fees, charges and other public levies shall be paid by the recipient.

4 Payment terms

Our individual offers may be paid for at your option by bank transfer, by credit card (VISA/MasterCard) or via Paypal.

5 Set-off; right of retention

You shall have a right of set-off only if your counter-claim has been determined without further legal recourse or is not disputed by us.

You may exercise a right of retention only where your counter-claim is based on the same contractual relationship.

6 Place of fulfillment, delivery; retention of title

The place of fulfillment for all obligations under this contractual relationship shall be Wertingen, Germany unless otherwise stated.

We shall select the mode of dispatch and the kind of packaging according to our best judgement.

Unless otherwise agreed, goods shall be delivered upon receipt of payment ex our warehouse to the delivery address specified by you.

The goods shall remain our property until full payment of the purchase price.

Any dates or periods for the delivery of goods or the provision of services announced by us shall always be without commitment, unless we promise a fixed period or date. With regard to the dispatch of goods, any delivery period or delivery date shall refer to the time of hand-over to the carrier, haulage contractor or other third party engaged by us for shipment.

Although, in principle, we make delivery to any place in the world, we reserve the right to decide on the delivery of goods ordered in each particular case.

We shall not be liable for any inability to deliver or any delay of delivery where this is caused by force majeure or any other circumstance which was unforeseeable at the time the contract was concluded. We shall be entitled to rescind the contract if such circumstances make delivery or service provision by us

substantially difficult or impossible. Where such impediment is just of a temporary nature, the delivery and service provision deadlines shall be extended accordingly.

We shall be entitled to make partial delivery if you can use the part of the delivery supplied to you in accordance with the contractual purpose, this does not cause any unacceptable additional expense to you and delivery of the remaining goods is ensured. We reserve title to the goods until complete settlement of all claims under the current business relationship. Prior to transfer of ownership of the goods under reservation of title, pledging or assignment as security shall not be permitted.

7 Right to return goods

You buy without risk because you are entitled to return the goods within ten days of receipt of the goods. This right does not apply to any goods already used or soiled which are made to customer specifications (e.g. hotel name printing) or are clearly tailored to personal requirements. To exercise your right of return, send the unused and clean goods back to us at your own expense, if possible in their original packaging, otherwise in a comparable safe packaging together with all accessories and all packaging components.

8 Warranty

The warranty period shall be one year from delivery of the goods. You are obligated to inspect the goods for quality defects and incorrect quantity without delay and with due diligence and notify us of any apparent defects within seven days of receipt of the goods. It shall be sufficient if the notice of defects is dispatched within the time limit. This shall also apply to any hidden defect detected later with respect to the time of detection. Warranty claims cannot be asserted if you fail to comply with your duty to inspect and notify us of a defect.

In the event of any defect, we shall at our option make subsequent improvement or substitute delivery (supplementary performance). In the case of subsequent improvement, we shall not have to bear the additional costs caused by the goods having been brought to a place other than the place of fulfilment, unless where such transfer is in compliance with the intended use of the goods.

If supplementary performance fails twice, you shall be entitled at your option to demand abatement or rescind the contract.

9 Liability

Unlimited liability: We shall be liable for wilful intent and gross negligence. In the event of slight negligence, we shall be liable in accordance with the provisions of the product liability act and for any damage caused by injury to life, body or health of any person.

Limitation of liability: Apart from that, we shall be liable in any case of slight negligence only for a breach of a material contractual obligation, i.e. a contractual obligation fulfilment which enables the proper performance of the contract in the first place and on which the contractual partner may typically rely. This limitation of liability shall also apply for the benefit of our vicarious agents.

10 Final provisions

Should any of the provisions of these General Terms and Conditions be or become invalid, this shall not affect the validity of the remaining provisions.

Should any provision which is actually necessary not be contained in the contract concluded between you and us or in these General Terms and Conditions, the parties hereto undertake to agree upon a valid provision which they would have agreed, taking account of their commercial goals, if they had realised the gap.

Any contract between you and us shall be governed exclusively by German law, excluding application of the United Nations Convention on Contracts for the International Sale of Goods (CISG).

The place of jurisdiction for any dispute arising from or in connection with a contract concluded between you and us shall be Wertingen, Germany.

Wertingen, January 2018



JOBELINE

work · fashion · fun

Workwear for Restaurant, Hotel & Catering

www.em-group.com

JOBELINE Collection 2018 – Lifestyle paired with diversity and fun!
Make no compromises to inspire your guests.
Be **Hip by JOBELINE!**

Shampoo, 50 ml
V-TOUCH SILKY WHITE

064

- More content for more luxury
- Paraben free
- With algae extracts (Laminaria digitata)



Care series V-TOUCH SILKY WHITE see page 6.

VEGA

JOBELINE

Parceiro exclusivo



www.DAUTI.pt

Hotelwäsche
Erwin Müller

pulsiva

Rua Nova, 420 | 4570-074 Balasar | Portugal Tel. +351 252 954 026 Fax. +351 252 955 335 | comercial@dauti.pt

10099890 EN0318TmP
Valid until 31.12.2018